



NORMFEST®

Products and service for
the automotive industry



EN 2017/18
CATALOG





Thank you for your trust!

Dear Customer,

This is the brand new edition of the Normfest catalogue. You will not only find numerous new products and innovations to facilitate your daily work, but also profit from the improved layout and extensive tips and tricks to maximise your efficiency.

Normfest has specialised in the vehicle repair sector for almost 65 years - from scooters and cars to trucks and giant cranes. This is our field and what we have built our reputation on.

Our staff live and breathe mobility in their daily work and are specially trained at our Normfest Academy to meet the demands of our customers.

There are many ways to contact Normfest. The most important contact is and remains your sales representative.

The sales representative knows you and your special wishes and preferences. Furthermore, you can also call our friendly staff at our customer service centre. And last but not least, there is our Online Shop, which we have designed with you, the customer, in mind to make it user friendly, clear and concise.

We realise that without our customers we could not exist. Therefore, we would like to say a big thank you for your continuous loyalty and trust. We will not disappoint you!

Best regards,
Normfest GmbH



Bernhard Windrich
Managing Director



Products and services for the automotive- industry

Normfest provides automotive specialists with everything they need to repair, maintain and service motor vehicles. Our range offers over 19,000 chemical and technical products.

Based in Velbert, Germany, Normfest also has offices in numerous European countries, e.g. Germany, Poland, Czech Republic, Slovakia, Croatia, Austria, Spain, Belgium, the Netherlands, Luxembourg, Great Britain and Bosnia and Herzegovina, where it employs around 400 people. Furthermore, we work closely with our specialist trade partners around the world and our sales network continues to expand.

We are naturally certified to DIN EN ISO 9001:2008 and tested to ISO/EC 27001.

Inspection & Maintenance



01

Adhesive grease

High-Press Ultra

- ▶ Item no. 2894-445-3
- ▶ Contents: 400 ml
- ▶ Packing unit: 12

▶ **Product description**

- Lubricates all moving machine components, e.g. hinges, check straps, chains, gear wheels, wire ropes, slide rails, etc.
- Excellent penetrating ability
- Outstanding adhesive property
- High pressure resistance
- Resistant to salt and hot water
- Temperature range -20°C to +140°C
- Colour: light-blue

02

High-Pressure Adhesive Lubricating Grease

High-Press Black

- ▶ Item no. 2894-445-2
- ▶ Contents: 400 ml
- ▶ Packing unit: 24

▶ **Product description**

- Suitable for use in all technical applications
- Excellent penetrating ability
- Outstanding adhesive property
- Water-repellent and protects against corrosion
- Best running characteristics at high temperatures and speeds
- Temperature range -20°C to +200°C
- Colour: black



03

High-Pressure Adhesive Lubricating Grease

High-Press

- ▶ Item no. 2894-445-1
- ▶ Contents: 400 ml
- ▶ Packing unit: 24

▶ **Product description**

- Highly water repellent
- Highly resistant to pressure
- Free from sticky polymer thickeners that trap dirt
- Silicone-free
- Outstanding adhesive property
- Excellent penetrating ability
- Temperature range -20°C to +140°C
- Colour: beige/transparent



01



02



03

01

PTFE/Ceramic oil spray

Teflux

- ▶ Item no. 2894-445-4
- ▶ Contents: 400 ml
- ▶ Packing unit: 12

- ▶ Item no. 2894-445-415
- ▶ Contents: 150 ml
- ▶ Packing unit: 12

▶ **Product description**

- Extremely creep-capable
- Water repellent and protects against corrosion
- High pressure resistance
- Lubricates and oils all moving machine parts such as gear wheels, hinges, etc.
- Excellent emergency-running properties thanks to PTFE and ceramic additives
- Silicone-free
- Colour: beige
- Fragrance: vanilla



IT MAKES EVERYTHING GO SMOOTHLY!



01

SAFETY FIRST

PROtect
DIE SANFTE CHEMIE



What exactly is a product ID using the GHS system?

GHS stands for „Globally Harmonious System of Classification and Labelling of Chemicals“ and is an ordinance of the European Union (EU). It is a globally uniform system for classifying chemicals and identifying them on packaging and on safety data sheets.

The GHS system has replaced the previous classification and identification system of the EU. It is regulated through the CLP Ordinance (Classification, Labelling and Packaging). It has had to be bindingly applied to materials since 1 December 2012. The second step of GHS implementation now affects compounds and thus all chemical and technical products. For this, GHS/CLP labelling will be legally mandatory from 1 June 2015.

This directive is primarily to protect users. Through the expanded texts of hazards and symbols, users of products should be able to better identify and assess products that are a risk to health and the environment.

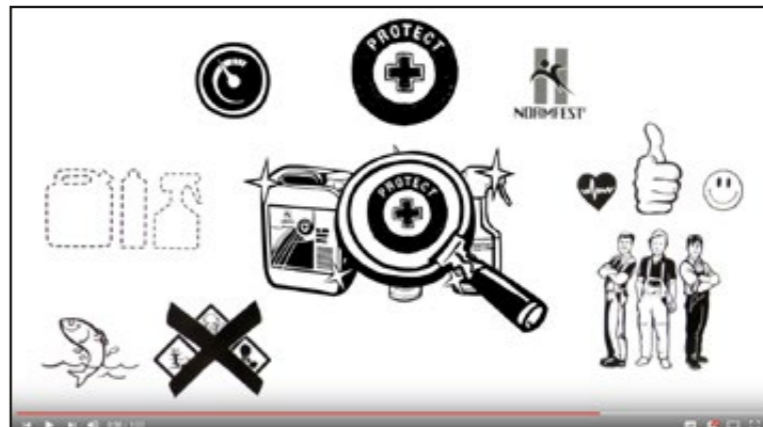

01

High-pressure adhesive grease

High-Press Protect

- ▶ Item no. 2894-445-5
- ▶ Contents: 400 ml
- ▶ Packing unit: 12

▶ **Technical specifications**

- H1 approval for food use
- Extremely shear-stable and adherent
- Resistant to salt and hot water
- Free of adhesive polymer thickeners
- Silicone-free
- Excellent high-pressure and high-temperature properties
- Quick-drying
- High layer thickness
- Good creep properties
- For all vehicles parts exposed to high pressure such as: door hinges, gear wheels, motorcycle chains, wire cables

02

White grease

Bio-Top Protect

- ▶ Item no. 2894-446
- ▶ Contents: 400 ml
- ▶ Packing unit: 24

▶ **Product description**

- Water repellent
- Good lubrication properties
- Good abrasion resistance
- Penetrative
- Moisture displacing
- Universal use
- Pressure resistant
- Extremely durable
- Very good adhesion
- Thermally stable from -10°C to +150°C

03

Maintenance lubricating oil spray

Fully synthetic

Multi Protect

- ▶ Item no. 2894-445-6
- ▶ Contents: 400 ml
- ▶ Packing unit: 12

▶ **Product description**

- Oxidation-resistant
- Capable of extreme creep
- Shear-stable
- Silicone-free
- Resistant to salt and hot water
- Optimal anti-corrosion properties
- Good high-pressure and high-temperature stability
- Thermally stable from -30°C to +150°C, +200°C in short term

04

Interior installation spray

Silicone-free - Soules Protect

Soules Protect

- ▶ Item no. 2897-449-1
- ▶ Contents: 300 ml
- ▶ Packing unit: 12

▶ **Technical specifications**

- Silicone free
- Eliminates moisture
- Does not resinify and provides long-lasting UV protection
- Anti-static
- Prevents door seals freezing in winter

LOOK OUT FOR THIS LOGO!!! TO BE ON THE SAFE SIDE



01



02



03



04



01
Silicone grease spray
Siltron

- ▶ Item no. 2897-324
- ▶ Contents: 400 ml
- ▶ Packing unit: 12

- ▶ **Product description**
- Creates effective water-repellent film
 - Lubricates and seals
 - Fully compatible with elastomers
 - Does not resinify and is extremely resistant to ageing
 - Insulates surfaces against creeping currents and flashovers also at high and low temperatures

02
Dry lubricant
TT - Power

- ▶ Item no. 2897-447
- ▶ Contents: 400 ml
- ▶ Packing unit: 12

- ▶ **Product description**
- Oil-free, grease-free, silicone-free
 - Invisible, hardly noticeable lubricating film
 - Prevents dust formation
 - Anti-static



01



02



03



04



05

03
Silicone Premium
Siprem

- ▶ Item no. 2897-322
- ▶ Contents: 400 ml
- ▶ Packing unit: 12

- ▶ **Product description**
- At least 18% of high-quality silicone
 - Highly water repellent
 - Leaves no marks
 - Exceptional lubricating qualities

04
Maintenance spray
ECO

- ▶ Item no. 2897-351-2
- ▶ Contents: 600 ml
- ▶ Packing unit: 12

- ▶ **Product description**
- Perfect lubrication at the most difficult-to-reach greasing points
 - Reduces friction
 - Water repellent

05
Silicone spray
ECO

- ▶ Item no. 2897-322-2
- ▶ Contents: 600 ml
- ▶ Packing unit: 12

- ▶ **Product description**
- Reduces squeaks
 - Water repellent
 - Impregnating
 - Leaves no marks

01
Injector, glow plug and spark plug igniter
Inject-Crack

- ▶ Item no. 2894-440
 - ▶ Contents: 250 ml
 - ▶ Packing unit: 12
-
- ▶ **Technical specifications**
- Removes deposits and oil residue
 - Up to 50% deeper creep effect than e.g. a standard rust remover
 - Free from mineral oils, acids and silicones
 - Very economical to use thanks to high percentage of active ingredient

02
Penetrating oil
Oxim Protect

- ▶ Item no. 2894-444-1
 - ▶ Contents: 400 ml
 - ▶ Packing unit: 12
-
- ▶ **Product description**
- Thermally stable from -20°C to +250°C
 - Use against rust, squeaks and creaks
 - Prevents further rusting

03
Rust Loosener Spray
Oxim Ultra

- ▶ Item no. 2894-444
 - ▶ Contents: 400 ml
 - ▶ Packing unit: 24
-
- ▶ Item no. 2894-441-1
- ▶ Contents: 5 litres
 - ▶ Packing unit: 1
-
- ▶ **Product description**
- Excellent lubricating properties
 - Provides good lubricity
 - Water-repellent
 - Shields against corrosive elements
 - Temperature range from -20°C to +250°C



04
Ice-rust remover
Super Crack Ultra

- ▶ Item no. 2894-442-1
 - ▶ Contents: 400 ml
 - ▶ Packing unit: 12
-
- ▶ **Product description**
- Excellent penetrating ability
 - Highly effective corrosion protection
 - Permanently water repellent
 - Guarantees extreme relubricating effect
 - Strong icing, cools to -40°C
 - High-performance separating agent with silver-coloured aluminium particles



01



02



03



IN THE VIDEO, SCHEUNE HAD A LITTLE JIT-



04



01

Brake cleaner
Bremtec

- ▶ Item no. 2897-333-600
- ▶ Contents: 600 ml
- ▶ Packing unit: 24
- ▶ Item no. 2897-333-5
- ▶ Contents: 5 litres
- ▶ Packing unit: 1

- ▶ Item no. 2897-333-30
- ▶ Contents: 30 litre
- ▶ Packing unit: 1

- ▶ Item no. 2897-333-60
- ▶ Contents: 60 litres
- ▶ Packing unit: 1

- ▶ **Product description**
- Contains acetone
- Degreasing action
- Carbon dioxide as the propellant



01

02

Metal discharge tap, R3/4"

- ▶ Item no. 2000-000-062

Locking adapter for metal discharge tap

- ▶ Item no. 2000-000-061



02

03

Brake cleaner
Bremtec

- ▶ Item no. 2897-333-31
- ▶ Contents: 30 litres
- ▶ Packing unit: 1

- ▶ **Product description**
- Basis: Benzoles, alcohols
- Ideal for the rapid removal of oil, dirt and brake dust from brake discs, pads and linings, as well as in the area around the intake and throttle valve
- Contains acetone



03

04

Pressure pump spray bottle
1 litre

- ▶ Item no. 2897-333-100
- ▶ **Product description**
- Operational overpressure 3 bar
- Suitable replacement sealant (optionally available): Art. no. 2897-333-101
- Empty
- Capacity 1 litre
- Labels to improve identification separately available
- For filling with the following Normfest products:
- Bremtec brake cleaner
- Power-Star tar remover
- Motor-Fit engine compartment conservation
- Oxim rust remover

05

Safety cleaner
Bremtec Safe

- ▶ Item no. 2897-333-700
- ▶ Contents: 500 ml
- ▶ Packing unit: 12
- ▶ Item no. 2897-333-730
- ▶ Contents: 30 litre
- ▶ Packing unit: 1
- ▶ **Product description**
- TÜV-tested fire behaviour
- TÜV-tested ingredients
- Flame-retarding propellant
- Lower explosion limit >1.5% Vol.
- Recommended product in accordance with the German Ordinance on Hazardous Materials (protection level 2)
- 25% naphtha- colourless



05



01
Brake cleaner
MC-1

- ▶ Item no. 2897-333-500
- ▶ Contents: 500 ml
- ▶ Packing unit: 30

▶ **Product description**

- Acetone-free quality cleaner
- Very effectively removes oil, dirt, brake fluid and brake dust from brake discs, pads and linings and many other vehicle parts
- Flushes out contaminants and deposits
- Removes oil, grease, dust, resin residues/brake fluid/brake dust from disk brakes
- The life of treated components is increased thanks to conditioning lubrication



01

02
Brake protection paste
Off-Shore Silver

- ▶ Item no. 2894-449-200
- ▶ Contents: 200 g
- ▶ Packing unit: 12

▶ **Product description**

- Special lubricant that provides reliable adhesion at high temperatures
- Condensation, splash and salt water proof
- Excellent and long-term lubrication
- Lasting corrosion protection
- Particularly suitable for vehicles with anti-lock brake system
- Temperature resistant up to



02

03
Brake protection spray
Off-Shore Silver

- ▶ Item no. 2894-449
- ▶ Contents: 400 ml
- ▶ Packing unit: 12

▶ **Product description**

- Condensation, splash and salt water proof
- Excellent and long-term lubrication
- Lasting corrosion protection
- Particularly suitable for vehicles with anti-lock brake system
- Temperature stability up to 1,400°C
- Metal-free
- Prevents corrosion and squeaking
- Silicone free
- Cold-flow properties guarantee



03



04

04
Off-Shore replacement brush

- ▶ Item no. 2894-448-201



05

05
Sealable lid
for used aerosol cans

- ▶ Item no. 2897-999

▶ **Product description**

- These caps are specially prescribed in VW workshops so that used aerosol cans can be closed in accordance with regulations. This prevents any possible leakage from the cans. Safety is simple - after use - spray head off - cap on!

01
Brake assembly paste
BMP

- ▶ Item no. 2894-400
- ▶ Contents: 5.50 ml
- ▶ Packing unit: 1

- ▶ Item no. 2894-405
- ▶ Contents: 250 g
- ▶ Packing unit: 1

- ▶ **Product description**
- Heat resistant to 1,100°C
- Resistant to alkalis and acids
- Can be universally used for assembly, screw fittings and as a lubricant



01

03
Brake fluid
DOT4

- ▶ Item no. 2894-410
- ▶ Contents: 5 litres
- ▶ Packing unit: 1

- ▶ Item no. 2894-410-30
- ▶ Contents: 30 litre
- ▶ Packing unit: 1

- ▶ **Product description**
- Suitable for all hydraulic braking systems with synthetic fluid
- Wet boiling point over +160°C
- Boiling point over +250°C

04
Brake fluid
DOT4 Plus

- ▶ Item no. 2894-415-05
- ▶ Contents: 500 ml
- ▶ Packing unit: 24

- ▶ Item no. 2894-415
- ▶ Contents: 5 litres
- ▶ Packing unit: 1

- ▶ Item no. 2894-415-30
- ▶ Contents: 30 litre
- ▶ Packing unit: 1

- ▶ **Product description**
- Suitable for all hydraulic braking systems using synthetic fluid
- Wet boiling point over +180°C
- Boiling point over +260°C

05
Spout for 5 litre containers

- ▶ Item no. 2000-000-005

Spout for 30 litre containers

- ▶ Item no. 2000-000-030

06
Brake fluid tester
Replacement battery 3722-24

- ▶ Item no. 8715-999-50

02
Copper grease
COP

- ▶ Item no. 2894-451-1
- ▶ Contents: 250 g
- ▶ Packing unit: 1

- ▶ Item no. 2894-450
- ▶ Contents: 400 ml
- ▶ Packing unit: 12

- ▶ Item no. 2894-451
- ▶ Contents: 100 g
- ▶ Packing unit: 10

- ▶ **Product description**
- Thermally stable to +1,200°C
- Do not apply to friction surfaces
- NOT RECOMMENDED FOR ABS VEHICLES



02



03

04

05

06

01

High-Performance Brake Fluid

DOT 4 LV High Performance

- ▶ Item no. 2894-435
- ▶ Contents: 5 litres
- ▶ Packing unit: 1

- ▶ Item no. 2894-430
- ▶ Contents: 30 litres
- ▶ Packing unit: 1

▶ **Product description**

- With special Ford licence
- Suitable for all hydraulic brake systems using synthetic fluid
- Can be mixed with brake fluid of the same specification
- Does not attack brake parts
- Increases safety thanks to reduced drop in boiling point
- Meets DOT-4 FMVSS 116 and SAEJ 1703
- Boiling point over +265° C
- Wet boiling point over +175° C



01

05

Airspray automatic filler

- ▶ Item no. 2897-910-100
- ▶ Item no. 2897-910-106
- ▶ Spare parts service station material/air

Replacement parts for Airspray pressure cylinders

- ▶ Item no. 2897-910-101
- ▶ A valve with a vertical hose
- ▶ Item no. 2897-910-102
- ▶ Spray head, circular jet
- ▶ Item no. 2897-910-108
- ▶ Spray head, spot jet

Spare parts for Airspray automatic filling machine

- ▶ Item no. 2897-910-103
- ▶ Material air valve
- ▶ Item no. 2897-910-104
- ▶ Air valve
- ▶ Item no. 2897-910-105
- ▶ Seal holder, including grooved ring
- ▶ Item no. 2897-910-110
- ▶ Barrel connector, including accessories for 60 litres

02

Airspray pressure cylinder for Bremtec A2

- ▶ Item no. 2897-910-1
- ▶ Contents: 400 ml
- ▶ Packing unit: 1



02

03

Airspray pressure cylinder for Bremtec

- ▶ Item no. 2897-910-2
- ▶ Contents: 400 ml
- ▶ Packing unit: 1



03

04

Airspray pressure cylinder for Oxim

- ▶ Item no. 2897-910-3
- ▶ Contents: 400 ml
- ▶ Packing unit: 1



04

06

Pressurised-air spray bottle
Refillable, 8 bar

- ▶ Item no. 2897-900

▶ **Product description**

- Suitable for all liquid materials that can be worked using compressed air



06



05

01

Seal remover

Seal-Ex

- ▶ Item no. 2896-663
- ▶ Contents: 400 ml
- ▶ Packing unit: 12

▶ **Product description**

- Can be used on objects made from metal, wood, ceramic, glass, polyethylene, polypropylene
- Do not use on delicate plastics such as PVC, linoleum or synthetics
- Never use on painted surfaces!

02

Silicone red

Silon Red

- ▶ Item no. 2896-640-1
- ▶ Contents: 200 ml
- ▶ Packing unit: 12

▶ **Product description**

- Hardens practically without shrinking (< 3%) to a hard, rubber-like mass as soon as exposed to air humidity
- Adheres to metal, glass, painted surfaces, ceramic and to most plastic surfaces
- Resistant to weathering, vibrations, moisture
- Thermally stable from -50°C to +300°C

03

Silicone black

Silon Black

- ▶ Item no. 2896-640-2
- ▶ Contents: 200 ml
- ▶ Packing unit: 12

▶ **Product description**

- Hardens practically without shrinking (< 3%) to a hard, rubber-like mass as soon as exposed to air humidity
- Adheres to metal, glass, painted surfaces, ceramic and to most plastic surfaces
- Resistant to weathering, vibrations, moisture
- Thermally stable from -50°C to +230°C

04

Spare pistol grip

- ▶ Item no. 2896-640-3



01



02



03

04

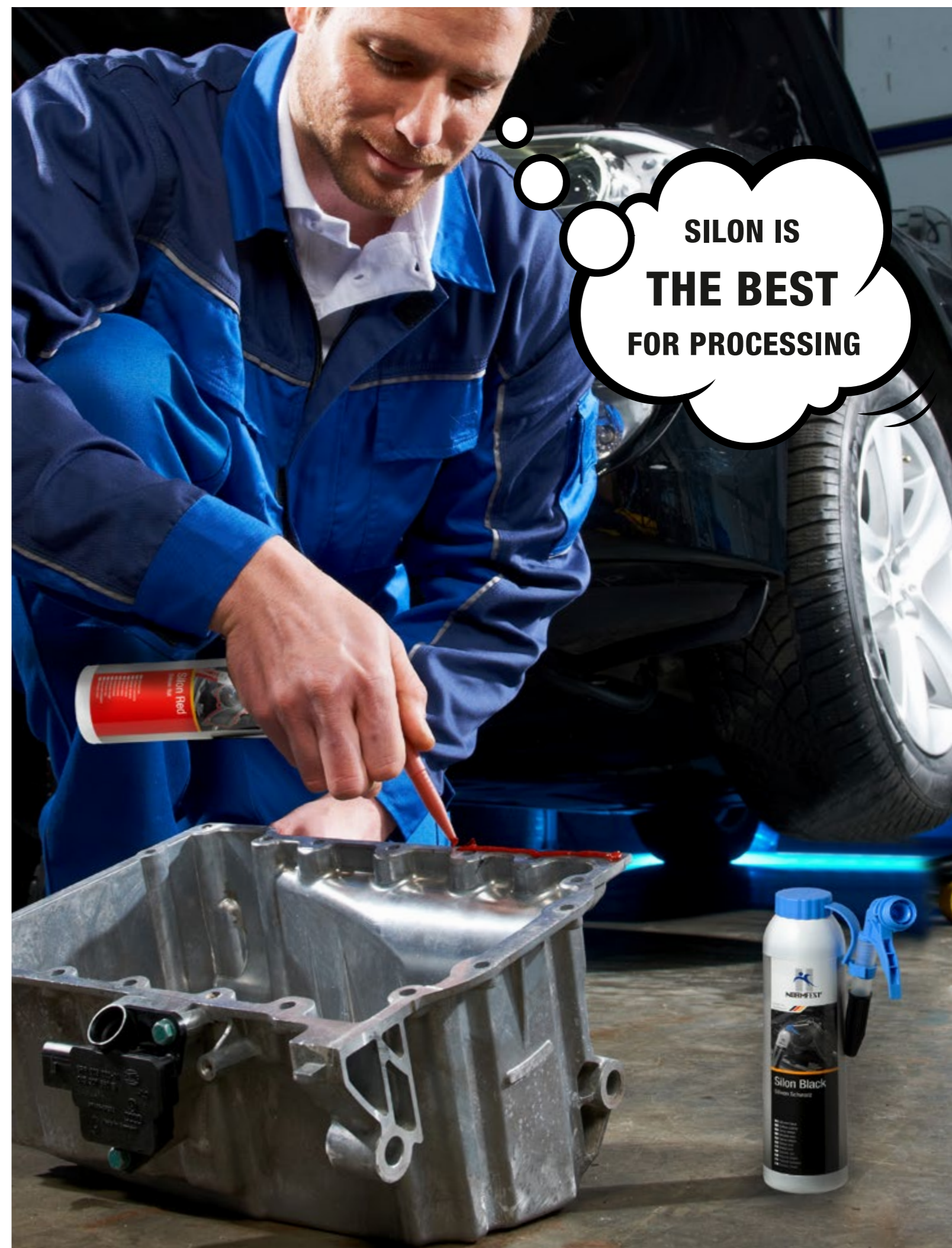

**SILON IS
THE BEST
FOR PROCESSING**

01 Multi-purpose grease BG-B

- ▶ Item no. 2986-02
 - ▶ Contents: 400 g
 - ▶ Packing unit: 12
-
- ▶ Product description
 - Colour: Black
 - Ideal for drive shafts
 - With graphite
 - Thermally stable from -30°C to +120°C
 - NLGI class 2

02 Multi-purpose grease BG-Y

- ▶ Item no. 2986-021
 - ▶ Contents: 400 g
 - ▶ Packing unit: 12
-
- ▶ Product description
 - Color: Yellow
 - Temperature range -30°C to +120°C
 - NLGI class 2

03 Lever-action grease press M10 x 1

- ▶ Item no. 7986-0
-
- ▶ Technical specifications
 - For 400 g cartridges or 500 g of loose grease
 - Short-stroke system
 - Stepless piston rod fixing
 - Filling / bleed valve
 - Ergonomic handle, compliant with DIN 1283
 - TÜV, DLG, BLT tested

04 High pressure reinforced tube

- ▶ Item no. 7986-03
-
- ▶ Product description
 - M10 x 1
 - For grease gun (7986-0)



06 Lever grease gun For lube-shuttle system cartridges

- ▶ Item no. 7986-1
-
- ▶ Product description
 - With galvanized-steel grease container
 - Ergonomically shaped lever gear
 - Pressure approx. 300 bar
 - Open the cartridge without tools
 - Simple, quick and absolutely clean loading and removal of grease cartridges - without opening the gun
 - No venting required
 - Optimal emptying of cartridge residues

07 Multi-purpose grease Greasal

- ▶ Item no. 2986-031
 - ▶ Contents: 400 g
 - ▶ Packing unit: 12
-
- ▶ Product description
 - Smooth texture
 - Soft consistency
 - Acid-free, shear-stable
 - Resistant to oxidation
 - Protects against rust
 - Thermally stable from -30°C to +120°C
 - NLGI class 2 (2K-30 to DIN 51 502)
 - Screw cartridge (lube-shuttle system cartridges)

05 Hydraulic claw mouthpiece

- ▶ Item no. 7986-04
-
- ▶ Product description
 - M10 x 1
 - to DIN 71412
 - for grease guns (7986-0)



01 Surface sealant, green

- ▶ Item no. 2896-520
- ▶ Contents: 50 g
- ▶ Packing unit: 1

▶ Product description

- max. gap filling capacity: 0.3 mm
- Thermally stable from -55°C to +150°C
- Resistant to water, mineral oils, synthetic lubricants, fuels, organic solvents and coolants
- Solid in 20-40 mins.
- Work hard in 1-3 hours

02 Surface sealant, orange

- ▶ Item no. 2896-521
- ▶ Contents: 50 g
- ▶ Packing unit: 1

▶ Product description

- max. gap filling capacity: 0.5 mm
- Thermally stable from -55°C to +150°C
- Resistant to water, mineral oils, synthetic lubricants, fuels, organic solvents and coolants
- Solid in 15-30 mins.
- Work hard in 1-3 hours

03 Hydraulic and pneumatic sealant
Anaerobic sealing compound

- ▶ Item no. 2896-550-50
- ▶ Contents: 50 ml
- ▶ Packing unit: 10

▶ Product description

- Strength class (DIN 30661): 10-14
- max. gap filling capacity: 0.50 mm
- max. thread: (metr) M80
- Thermally stable from -55°C to +150°C
- Solid in 15-30 mins.
- Work hard in 1-3 hours
- Resistant to petrol, diesel, water, water-glycol mixtures, mineral oils, hydraulic fluids



04 Screw-Lock "medium-strength"

- ▶ Item no. 2896-531
- ▶ Contents: 24 ml
- ▶ Packing unit: 1

- ▶ Item no. 2896-531-50
- ▶ Contents: 50 ml
- ▶ Packing unit: 1

▶ Product description

- medium strength, strength class (DIN 30661)
- max. gap filling capacity: 0.25 mm
- max. thread (metric) M36
- Thermally stable from -55°C to +150°C
- Solid in 10-20 mins.
- Work hard in 1-3 hours

05 Screw-Lock "high-strength"

- ▶ Item no. 2896-530
- ▶ Contents: 24 ml
- ▶ Packing unit: 1

- ▶ Item no. 2896-530-50
- ▶ Contents: 50 ml
- ▶ Packing unit: 1

▶ Product description

- high-strength, strength class (DIN 30661)
- max. gap filling capacity: 0.15 mm
- max. thread (metric) M20
- Thermally stable from -55°C to +150°C
- Solid in 10-20 mins.
- Work hard in 1-3 hours



01



02



03



04



05

01
Pipe thread sealing

- ▶ Item no. 2896-550-51
- ▶ Contents: 50 ml
- ▶ Packing unit: 12

▶ **Product description**

- Strength class (DIN 30661): 10-14
- max. gap filling capacity: 0.50 mm
- Max. thread: (metr) M80
- ?-55°C to +150°C
- Solid in 15-30 mins.
- Work hard in 1-3 hours
- Resistant to petrol, diesel, water, water-glycol mixtures, mineral oils, hydraulic fluids
- Exception: High-concentration acids and alkalis, and methylene chloride



01

02
fastening of the brass and bearing

- ▶ Item no. 2896-540
- ▶ Contents: 24 ml
- ▶ Packing unit: 12

▶ **Product description**

- Strength class (DIN 30661): 55-70
- max. gap filling capacity: 0.15 mm
- max. thread: (metr) M20
- Thermally stable from -55°C to +175°C
- Solid in 2-5 mins.
- Work hard in 1-3 hours



02

03
Duroplastic universal seal with dispensing grommet
Plastomar

- ▶ Item no. 2896-502
- ▶ Contents: 85 g
- ▶ Packing unit: 10

▶ **Product description**

- Temperature stable from -55°C to +270°C
- Allow to evaporate for 10 minutes
- Max. gap filling capacity 0.2 mm
- Silicone-free
- Colour: red



03

04
Engine sealer
MotSeal

- ▶ Item no. 2897-374
- ▶ Contents: 300 ml
- ▶ Packing unit: 12

▶ **Product description**

- Prevents exhaust bluing
- Replenishes rubber and plastic seals
- Stops environmentally-unfriendly oil leaks



04

05
Engine oil cleaner
MotClean

- ▶ Item no. 2897-375
- ▶ Contents: 500 ml
- ▶ Packing unit: 12

▶ **Product description**

- Gentle and quick cleaning
- Safe for seals and other engine materials
- Cost-effective
- Simple application



05

01

Radiator sealer

RadSeal

- ▶ Item no. 2897-372
- ▶ Contents: 150 ml
- ▶ Packing unit: 12

▶ Product description

- Seals hairline cracks and small leaks permanently and reliably
- Compatible with anti-freezes and coolants, does not attack rubber, plastics, light alloys or non-ferrous heavy metals
- No negative effects on water pumps or heating circuits
- Suitable for closed cooling systems
- Suitable for aluminium radiators
- Also suitable for precautionary use

02

Radiator Cleaner

RadClean

- ▶ Item no. 2897-373
- ▶ Contents: 250 ml
- ▶ Packing unit: 12

▶ Product description

- Chemical conversion of lime
- Dissolves grease, lime and oil
- Disperses sludge
- Does not attack radiator materials
- Safe for rubber and plastic
- Compatible with anti-freezes
- Does not contain aggressive acids or alkalis

03

Diesel additive

CT 60

- ▶ Item no. 2897-370
- ▶ Contents: 300 ml
- ▶ Packing unit: 12

▶ Product description

- Cleans and prevents deposits in the fuel system and combustion chamber
- Keeps the injector nozzles clean, improves combustion, resulting in less specific fuel consumption and maximum engine performance
- Prevents sticky deposits on the injector needles
- Increases lubrication when using low sulphur diesel fuels and protects the distributor fuel injection pumps against wear
- Fully compatible with all modern diesel oxidation catalysts

04

Petrol additive

OT 100

- ▶ Item no. 2897-371
- ▶ Contents: 300 ml
- ▶ Packing unit: 12

▶ Product description

- Suitable for all petrol injection systems
- Cleans carbon deposits from injection systems
- Removes coking and deposits from fuel distributors, injection valves, intake valves and other components of the fuel system
- Ensures optimum performance and fuel economy through accurate injection and atomization
- Guarantees low exhaust emissions



01



02



03



04



01
Diesel Air-Intake System Cleaner
DC980

- ▶ Item no. 2897-369
- ▶ Contents: 400 ml
- ▶ Packing unit: 8

- ▶ **Product description**
- Special cleaner with CO2 propellant
 - Simple and specific use
 - Colourless and residue free
 - Powerful solvent action
 - Over 95% active ingredients



01

02
Diesel soot-particle filter cleaner
DPF100

- ▶ Item no. 2897-380
- ▶ Contents: 400 ml
- ▶ Packing unit: 12

- ▶ **Product description**
- Outstanding at loosening carbon deposits
 - Non-flammable
 - Clean without having to dismantle the particle filter
 - Restore the full absorbency of the diesel particle filter



02

03
Throttle cleaner
VC 980

- ▶ Item no. 2897-368
- ▶ Contents: 400 ml
- ▶ Packing unit: 12

- ▶ **Product description**
- Cleans the carburettor from the inside and outside
 - Rinses boreholes and nozzles
 - Ideal for cleaning components in the intake area
 - Exhaust gas regulation valve

04
Long hose, incl. spray head
for VC 980

- ▶ Item no. 2897-368-1



04



05

05
Electrical contact cleaner
TermClean

- ▶ Item no. 2897-334
- ▶ Contents: 400 ml
- ▶ Packing unit: 12

- ▶ **Product description**
- Cleans all contacts
 - Facilitates the removal of greasy contamination and loosens old incrustations
 - Safe to use on electrical and mechanical office machines, computers, cash registers, radios and televisions
 - Comes with brush attachment

- Product not suitable for use on parts being used!



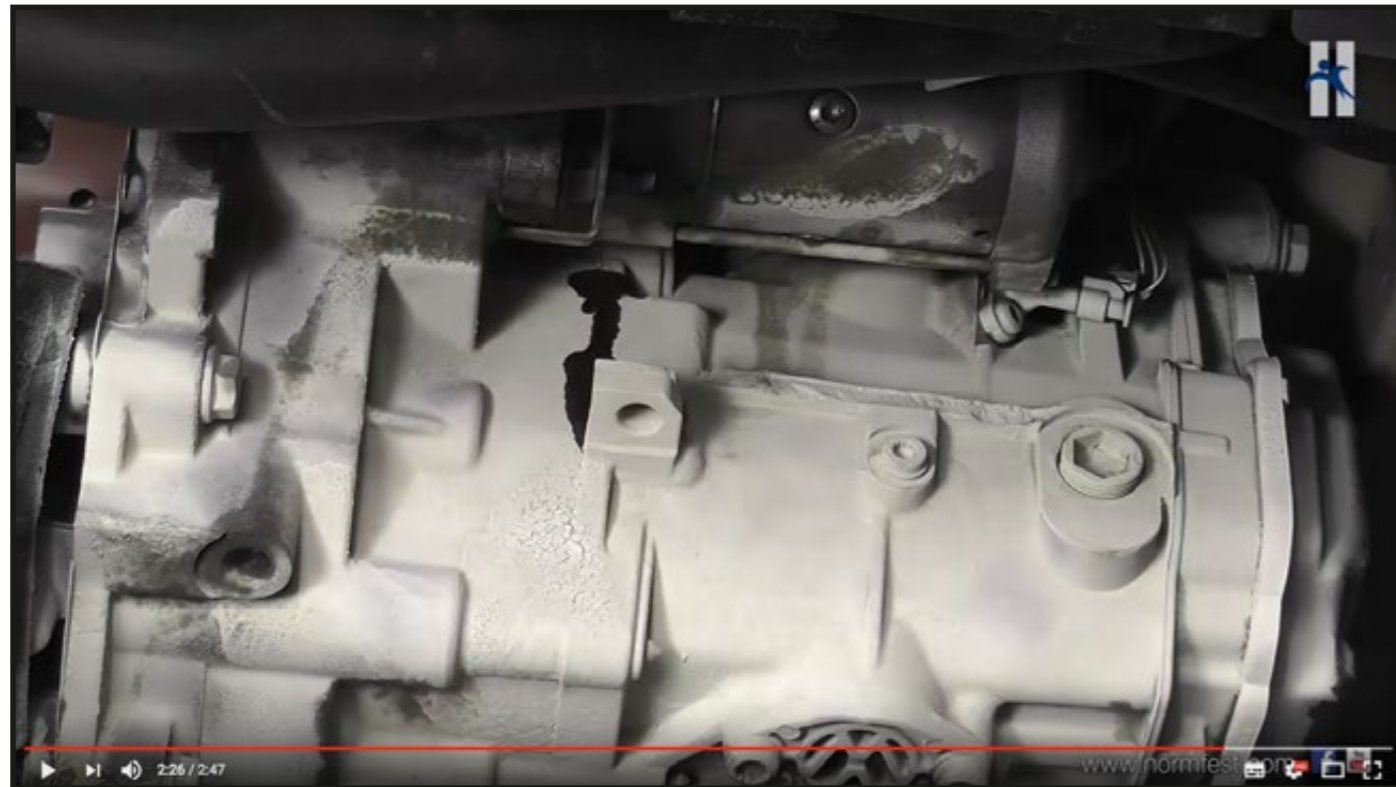

01
Leak-Finder Spray
Spy Dry

- ▶ Item no. 2896-662
- ▶ Contents: 400 ml
- ▶ Packing unit: 12

- ▶ Technical specifications
- Saves time diagnosing leaks
- Non-flammable
- Free from grease and silicone

**WITH THIS PRODUCT
YOU CAN SAVE
VALUABLE TIME!!!**



01

02
Leak Detector
Spy Plus

- ▶ Item no. 2896-661
- ▶ Contents: 400 ml
- ▶ Packing unit: 12

- ▶ Product description
- Meets the requirements of DIN EN 14291
- Non-flammable leak detection possible even of flammable gases
- Suitable for all technical gases in compressed-air, compressed-gas and air-conditioning systems, compressors, welding apparatus, compressed-air brake systems, tyres, hoses and transport tanks
- No stress corrosion cracking on plastics such as PVC or PE
- Temperature range: -15°C to +50°C
- Non-corrosive



02

03
Freezer Spray
Arctic

- ▶ Item no. 2897-325
- ▶ Contents: 200 ml
- ▶ Packing unit: 12

- ▶ Product description
- Metal structural parts such as ball bearings, sleeves, chain links, shafts, etc. can be inserted into the tightest of fits
- Can be used to easily find electrical faults in circuits (due to thermal overload) through local cooling
- Also excellent at removing dirt such as chocolate and chewing gum from upholstery



03

04
Marten repeller spray
Wild Guard

- ▶ Item no. 2897-329
- ▶ Contents: 400 ml
- ▶ Packing unit: 12

- ▶ Technical specifications
- Helps to effectively deter martens
- Double-effect means that electric cables, ignition cables, brake and coolant tubes, sleeves and fan belts are protected from marten bites
- Reapplied after every engine and underbody wash



04





01
Starting aid spray
Super Start Plus

- ▶ Item no. 2897-330-310
- ▶ Contents: 300 ml
- ▶ Packing unit: 12

- ▶ **Product description**
- Very high ignition properties
 - Facilitates cold starting even in extremely low temperatures
 - Improves starting when wet
 - Suitable for 2- and 4-stroke petrol engines
 - Also suitable for diesel engines (follow instructions for use on the product: ☑Start diesel engines at full throttle, do not preheat!

02
Contact helper
Contac

- ▶ Item no. 2897-331
- ▶ Contents: 300 ml
- ▶ Packing unit: 12

- ▶ **Product description**
- Eliminates moisture
 - Improves electrical conductivity

03
Battery-terminal protection spray
Poltec

- ▶ Item no. 2897-332-300
- ▶ Contents: 300 ml
- ▶ Packing unit: 12

- ▶ **Product description**
- insulates bright sheet connections and electrical connections against corrosion from environmental agents (salts, water, acids, alkalis, moisture, etc.)

04
Battery acid tester
▶ Item no. 8853-600-2



01

02

03

04



01 Intensive window cleaner Topas

- ▶ Item no. 2897-310
- ▶ Contents: 400 ml
- ▶ Packing unit: 24

- ▶ Item no. 2000-03
- ▶ Contents: 5 litres
- ▶ Packing unit: 1

- ▶ Product description
- Silicone-free
- Also suitable for polycarbonate glass
- Safe for surfaces
- Foam formation only after the surface has been coated with the product



03

01

02 High-tech special cleaner Terpanol Power

- ▶ Item no. 2897-323
- ▶ Contents: 400 ml
- ▶ Packing unit: 12

- ▶ Product description
- Contains orange terpene from 100% renewable raw materials
- Effortlessly removes adhesive residue, oil, grease, wax, permanent marker ink (Edding), graffiti
- Deals with the respective dirt effectively and quickly
- Solubilises after a very short time (approx. 20 seconds)

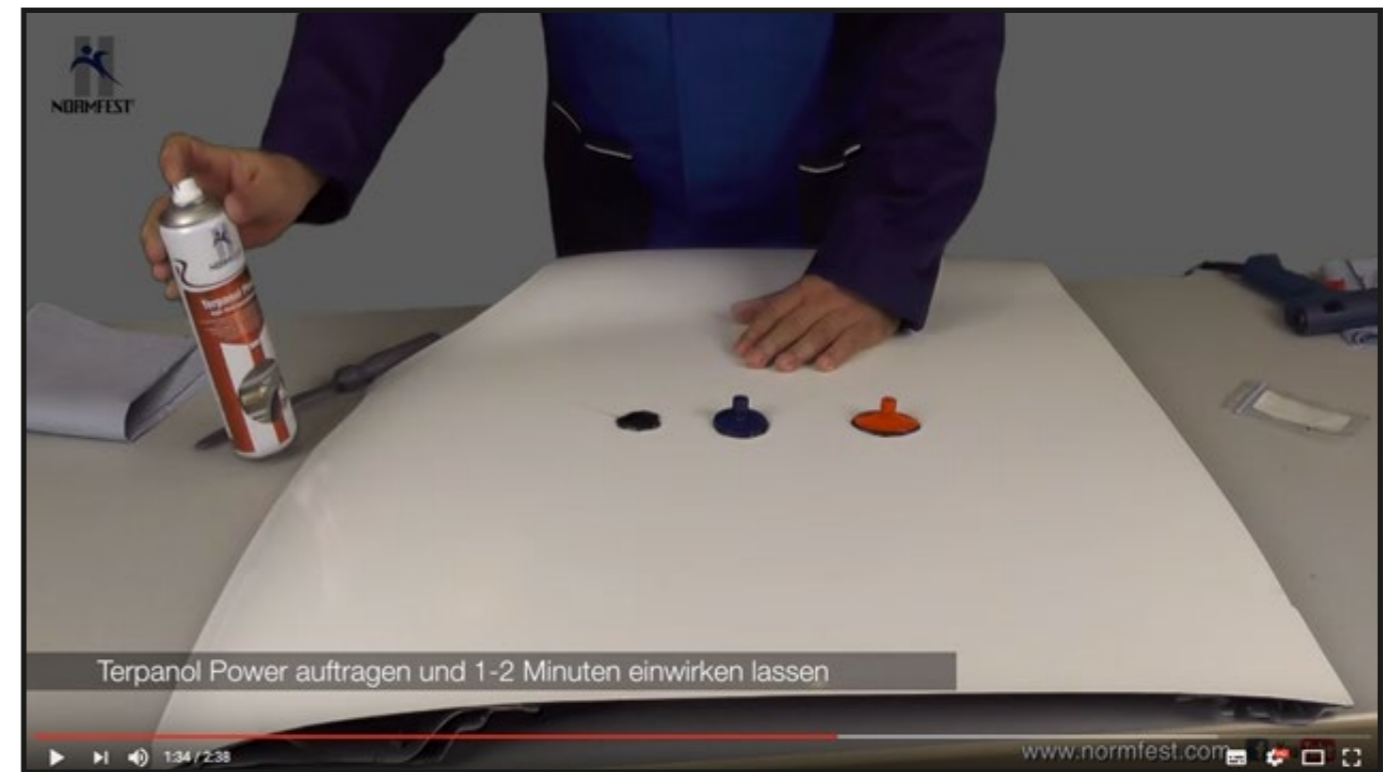

03 Spout for 5 litre containers

- ▶ Item no. 2000-000-005



03

04 Sealable lid for used aerosol cans

- ▶ Item no. 2897-999



04

NEU



01
Anti-freeze concentrate for windscreen washing system
Frostex

- ▶ Item no. 2897-312
- ▶ Contents: 500 ml
- ▶ Packing unit: 20

- ▶ Item no. 2897-314
- ▶ Contents: 1000 ml
- ▶ Packing unit: 12

- ▶ Item no. 2897-318
- ▶ Contents: 30 litre
- ▶ Packing unit: 1

- ▶ Item no. 2897-319
- ▶ Contents: 60 litres
- ▶ Packing unit: 1

- ▶ Product description
- Methanol free
- Undiluted frost-proof up to -70°C
- Suitable for fan nozzles and polycarbonate windscreens



01

02
Express de-icer
Blizzard Ultra

- ▶ Item no. 2897-231
- ▶ Contents: 500 ml
- ▶ Packing unit: 6

- ▶ Product description
- De-ices windscreens quickly
- Leave no smears
- No need to scrape off frost, ice or snow



02

03
Anti-freeze tester for cooling water

- ▶ Item no. 8853-600-1



03

04
Anti-freeze for windscreen washer systems

- ▶ Item no. 8853-600-3



04

05
Dispensing pump for 5-litre container

- ▶ Item no. 2897-313-509

- ▶ Product description
- 1 spray (2.5 ml)



05

06
Windscreen washing system concentrate
Flash

- ▶ Item no. 2897-313-100
- ▶ Contents: 30 ml
- ▶ Packing unit: 100

- ▶ Item no. 2897-313-5
- ▶ Contents: 5 litres
- ▶ Packing unit: 1

- ▶ Product description
- Summer product – only suitable for temperatures above 7°C
- Suitable for fan nozzles and polycarbonate windscreens
- One bottle (30 ml) = 4 litres of water



06



01



02



03



06



07



08

01 Super-fast superglue
Cyanacrylate adhesives black

- ▶ Item no. 2898-555
 - ▶ Contents: 5 g
 - ▶ Packing unit: 1
-
- ▶ Item no. 2898-556
 - ▶ Contents: 20 g
 - ▶ Packing unit: 1
-
- ▶ Product description
 - Suitable for smooth plastic surfaces
 - Pinpoint application accuracy

02 Black cyanacrylate adhesive Superfast

- ▶ Item no. 2898-560-20
 - ▶ Contents: 20 g
 - ▶ Packing unit: 1
-
- ▶ Product description
 - Suitable for bonding rubber coatings, plastics and metals
 - Ideal for bonding plastics, such as door clips
 - Based on cyanacrylate

03 Superglue filler
For cyanoacrylate adhesives

- ▶ Item no. 2898-560-30
 - ▶ Contents: 30 g
 - ▶ Packing unit: 1
-
- ▶ Product description
 - Density: > 1.5g/cm³ 20°C

06 Superglue gel
Fixit

- ▶ Item no. 2898-554
 - ▶ Contents: 20 g
 - ▶ Packing unit: 1
-
- ▶ Product description
 - Does not run
 - Can be used on horizontal and vertical surfaces
 - Does not form strings
 - For bonding metals, wood and plastics
 - Based on cyanacrylate

07 Accelerator
Fixit Active

- ▶ Item no. 2898-554-150
 - ▶ Contents: 200 ml
 - ▶ Packing unit: 1
-
- ▶ Product description
 - Suitable as a curing accelerator for all cyanacrylate adhesives
 - For leather, wood, cork, ceramics and all porous materials and for bonding plastics

08 Power spray adhesive Super-Glue

- ▶ Item no. 2898-552
 - ▶ Contents: 400 ml
 - ▶ Packing unit: 12
-
- ▶ Product description
 - Foamed materials, jute, felt, expanded polystyrene
 - Paper, cardboard, plastic films
 - Various plastics
 - Temperature range (permanent): -25°C to +70°C

04 Extreme cyanoacrylate superglue Rapido

- ▶ Item no. 2898-555-100
 - ▶ Contents: 20 g
 - ▶ Packing unit: 12
-
- ▶ Product description
 - For extreme loads and flexible adhesions
 - Basis: cyanoacrylate



04

05 Rubber profile adhesive Profix

- ▶ Item no. 2898-551
 - ▶ Contents: 180 g
 - ▶ Packing unit: 12
-
- ▶ Product description
 - Ideal for gluing: Rubber profile, leather, plastic, imitation leather with textile backing and felt to metal, wood, rigid PVC, ABS, PA



05

09 Two-component cyanoacrylate adhesive 2-c CA

- ▶ Item no. 2700-25
 - ▶ Contents: 10 g
 - ▶ Packing unit: 1
-
- ▶ Product description
 - Rapid hardening
 - For up to 6 mm gaps
 - Gel consistency (for work on vertical surfaces)
 - No drips
 - Accurate and clean application using the mixer nozzle
 - Perfect for all quick repairs to damaged components and for emergency repairs
 - Outstanding adhesive properties for almost every current material
 - Handling time: 90 - 150 seconds, depending on the

NEU

10 Mix nozzles, 10 pieces

- ▶ Item no. 2700-25-1



09

01

Windscreen wiper replacement rubbers

Refex



▶ **Item no. 5850-63-610**

▶ **Product description**

- Length 610 mm
- Width of claw hoop 6.3 mm
- For cars
- Incorrect insertion is impossible
- For replacing windcreens and rear windcreens

▶ **Item no. 5850-63-750**

▶ **Product description**

- Length 750 mm
- Width of claw hoop 6.3 mm
- For car and truck windcreens
- Incorrect insertion is impossible
- For

▶ **Item no. 5850-00-100**

▶ **Technical specifications**

- Front wiper for Asian cars and OPEL Insignia

▶ **Item no. 5850-00-750**

▶ **Product description**

- Length 750 mm
- Replacement rubber blades for current aero / flat blade windscreen wipers
- For cars and commercial vehicles
- Incorrect insertion is impossible
- For replacing windcreens and rear windcreens

▶ **Item no. 5850-851-050**

▶ **Product description**

- Length 1050 mm
- Width of claw hoop 8.5 mm
- For buses, construction machinery and agricultural machinery
- Incorrect insertion is impossible
- For replacing windcreens and rear windcreens

▶ **Item no. 5850-00-200**

▶ **Technical specifications**

- Rear wiper for Asian cars and some FIAT
-
- Toyota
- Daewoo
- Mazda
- Mitsubishi
- Honda Nissan
- Hyundai
- Proton
- Isuzu
- SaangYong
- Kia
- Subaru
- Lexus
- Suzuki
- Mahindra
- Tata
- Dayhatsu
- Infinity
- Alfa Romeo
- Fiat



02

Replacement wedge for adjusting the claw

▶ **Item no. 5850-63**

▶ **Product description**

- 6.3 mm, for adjusting the claw hoop

▶ **Item no. 5850-85**

▶ **Product description**

- Claw width: 8.5 mm



03

Universal shears Item no. 8714-05

▶ **Product description**

- Very robust
- Cuts sheet steel, wire, plastic, rubber, leather, cardboard, paper, carpet, flowers, branches, etc.
- Practical metal one-hand lock



01

Copper sealing rings DIN 7603 A, solid

Item no.	Implementation	Item no.	Implementation
6460-5-9	5 x 9 1.0 mm	6460-16-24	16 x 24 x 1.5 mm
6460-6-10	6 x 10 x 1.0 mm	6460-18-22	18 x 22 x 1.5 mm
6460-6-12	6 x 12 x 1.0 mm	6460-18-24	18 x 24 x 1.5 mm
6460-8-12	8 x 12 x 1.0 mm	6460-20-24	20 x 24 x 1.5 mm
6460-8-14	8 x 14 x 1.0 mm	6460-20-26	20 x 26 x 1.5 mm
6460-10-12	10 x 12 x 1.0 mm	6460-22-27	22 x 27 x 1.5 mm
6460-10-14	10 x 14 x 1.0 mm	6460-22-29	22 x 29 x 1.5 mm
6460-10-16	10 x 16 x 1.5 mm	6460-24-30	24 x 30 x 2.0 mm
6460-10-18	10 x 18 x 1.5 mm	6460-24-32	23 x 32 x 2.0 mm
6460-12-16	12 x 16 x 1.5 mm	6460-26-32	26 x 32 x 2.0 mm
6460-12-18	12 x 18 x 1.5 mm	6460-26-34	26 x 34 x 2.0 mm
6460-14-18	14 x 18 x 1.5 mm	6460-27-32	27 x 32 x 2.0 mm
6460-14-20	14 x 20 x 1.5 mm	6460-28-34	28 x 34 x 2.0 mm
6460-14-22	14 x 22 x 1.5 mm	6460-30-36	30 x 36 x 2.0 mm
6460-16-20	16 x 20 x 1.5 mm	6460-32-38	32 x 38 x 2.0 mm
6460-16-22	16 x 22 x 1.5 mm		



02

Aluminium washers DIN 7603 A

Item no.	Implementation	Item no.	Implementation
6463-6-10	6 x 10 x 1.0	6464-114-22	14 x 22 x 2.0
6463-8-12	8 x 12 x 1.0	6463-16-20	16 x 20 x 1.5
6463-8-14	8 x 14 x 1.0	6463-16-22	16 x 22 x 1.5
6463-10-14	10 x 14 x 1.0	6463-18-22	18 x 22 x 1.5
6463-10-16	1.0 x 16 x 1.0	6463-18-24	18 x 24 x 1.5
6463-12-16	12 x 16 x 1.0	6463-20-26	20 x 26 x 1.5
6463-12-18	12 x 17 x 1.5	6463-22-27	22 x 27 x 1.5
6463-14-18	14 x 18 x 1.5	6463-24-30	24 x 30 x 2.0
6463-14-20	14 x 20 x 1.5	6463-26-32	26 x 32 x 2.0



03

Perbunan O-rings, metric

Item no.	Inner Ø mm	Ring thickness mm
6468-003-20	3	2,0
6468-004-20	4	2,0
6468-005-20	5	2,0
6468-006-20	6	2,0
6468-007-20	7	2,0
6468-008-20	8	2,0
6468-010-20	10	2,0
6468-010-25	10	2,5
6468-012-20	12	2,0
6468-012-25	12	2,5
6468-014-25	14	2,5
6468-015-25	15	2,5
6468-017-25	17	2,5
6468-018-30	18	3,0
6468-019-25	19	2,5
6468-020-30	20	3,0
6468-022-30	22	3,0
6468-024-30	24	3,0
6468-025-30	25	3,0
6468-028-30	28	3,0
6468-030-30	30	3,0
6468-034-30	34	3,0
6468-035-35	35	3,5
6468-036-30	36	3,0
6468-038-30	38	3,0



04

Copper twin rings DIN 7603

- ▶ **Item no. 6464-6-10**
- ▶ **Product description**
- Developed for use on banjo bolts and banjo unions
- facilitates the assembly and increases security when fitted due to the washer connection



05

Copper fill sealing rings DIN 7603 C

Item no.	Implementation
6462-12-18	12 x 18 x 2.0
6462-14-20	14 x 20 x 2.0
6462-14-21	14 x 21 x 2.0
6462-14-22	14 x 22 x 2.0
6462-16-20	16 x 20 x 2.0
6462-16-22	16 x 22 x 2.0
6462-18-24	M18 x 24 x 2.0



01

Copper sealing ring assortment DIN 7603A

► Item no. 1957-460

Contents: 1,190 parts

- 100 x 6 x 10 x 1 (Art. No. 6460-6-10)
- 100 x 8 x 12 x 1 (art. no. 6460-8-12)
- 100 x 8 x 14 x 1 (Art. No. 6460-8-14)
- 100 x 10 x 14 x 1 (Art. No. 6460-10-14)
- 100 x 10 x 16 x 1 (Art. No. 6460-10-16)
- 100 x 12 x 16 x 1.5 (Art. No. 6460-12-16)
- 100 x 12 x 18 x 1.5 (Art. No. 6460-12-18)
- 50 x 14 x 18 x 1.5 (Art. No. 6460-14-18)
- 50 x 14 x 20 x 1.5 (Art. No. 6460-14-20)
- 50 x 14 x 22 x 1.5 (Art. No. 6460-14-22)
- 50 x 16 x 22 x 1.5 (Art. No. 6460-16-22)
- 50 x 18 x 24 x 1.5 (Art. No. 6460-18-24)
- 50 x 20 x 26 x 1.5 (Art. No. 6460-20-26)
- 50 x 22 x 27 x 1.5 (Art. No. 6460-22-27)
- 50 x 22 x 29 x 1.5 (Art. No. 6460-22-29)
- 30 x 24 x 30 x 2 (Art. No. 6460-24-30)
- 30 x 26 x 32 x 2 (Art. No. 6460-26-32)
- 30 x 28 x 34 x 2 (Art. No. 6460-28-34)



01

02

Assortment of gaskets for oil-drain plugs

► Item no. 1957-462

Contents: 1,000 parts

- 100 x Copper sealing ring shape A 12 x 18 x 1.5 (art. no. 6460-12-18)
- 100 x Copper sealing ring shape A 14 x 20 x 1.5 (art. no. 6460-14-20)
- 100 x Copper sealing ring shape C 14 x 21 x 2 (art. no. 6462-14-21)
- 100 x Copper sealing ring shape C 16 x 22 x 2 (art. no. 6462-16-22)
- 100 x Copper sealing ring shape C 18 x 24 x 2 (art. no. 6462-18-24)
- 100 x Aluminium sealing ring shape A 12 x 17 x 1,5 (art. no. 6463-12-18)
- 50 x Toyota sealing ring NF231 12 x 24 x 2 (art. no. 6464-012-242)
- 50 x Nissan folding ring 11 x 17 x 3 (art. no. 6464-11-17)
- 50 x Ford gasket NBR 70 12.8 x 22.5 x 3 (art. no. 6464-128-225)
- 100 x Plastic sealing ring PA6 14.5 x 22 x 2 (art. no. 6464-14-22)
- 50 x Ford sealing ring 16.7 x 24 x 2 large lip (art. no. 6464-16-24)
- 100 x Opel NBR 70 sealing ring 18 x 22 x 2 (art. no. 6464-18-2)



02

03

Perbunan O-ring assortment

► Item no. 1957-468-1



Contents: 1,050 parts

- 100 x 3.00 x 2.00 (art. no. 6468-003-20)
- 100 x 4.00 x 2.00 (art. no. 6468-004-20)
- 100 x 5.00 x 2.00 (art. no. 6468-005-20)
- 100 x 6.00 x 2.00 (art. no. 6468-006-20)
- 100 x 7.00 x 2.00 (art. no. 6468-007-20)
- 100 x 8.00 x 2.00 (art. no. 6468-008-20)
- 50 x 10.00 x 2.00 (art. no. 6468-010-20)
- 50 x 10.00 x 2.50 (art. no. 6468-010-25)
- 50 x 12.00 x 2.00 (art. no. 6468-012-20)
- 50 x 12.00 x 2.50 (art. no. 6468-012-25)
- 50 x 14.00 x 2.50 (art. no. 6468-014-25)
- 50 x 15.00 x 2.50 (art. no. 6468-015-25)
- 25 x 17.00 x 2.50 (art. no. 6468-017-25)
- 25 x 18.00 x 3.00 (art. no. 6468-018-30)
- 25 x 19.00 x 2.50 (art. no. 6468-019-25)
- 25 x 20.00 x 3.00 (art. no. 6468-020-30)
- 25 x 22.00 x 3.00 (art. no. 6468-022-30)
- 25 x 24.00 x 3.00 (art. no. 6468-024-30)







03

Alfa Romeo

-  Ø screw M18 x 1.5 x 12 mm
Item no. 6242-18-15
Original no. 46476967
-  Ø gasket 18 x 24 x 1.5 mm
Item no. 6460-18-24
Original no. 55196309

Audi



-  Ø screw M14 x 1.5 x 12 mm
Item no. 6242-014-15
Original no. 652475
-  Ø gasket 14 x 20 x 1.5 mm
Item no. 6460-14-20
-  Ø screw M14 x 1.5 x 17.5 mm
Item no. 6240-14-151
-  Ø gasket 14 x 20 x 1.5 mm
Item no. 6460-14-20
-  Screw Ø including sealing ring M14 x 1.5 x 22 mm
Item no. 6243-14-161

BMW

-  Ø screw M12 x 1.5 x 18 mm
Item no. 6243-12-15
Original no. 11131273093
-  Ø gasket 12 x 17 x 1.5 mm
Item no. 6463-12-18
-  Ø gasket 22 x 27 x 1.5 mm
Item no. 6464-022-015
-  Ø screw M12 x 1.5 x 12 mm
Item no. 6241-12-15
Original no. 29973430
-  Ø gasket 12 x 17 x 1.5 mm
Item no. 6463-12-18
-  Plastic, including sealing ring
Item no. 6243-30-4

NEU

Citroën

-  Ø screw 16 mm
Item no. 6242-16-15
-  Ø gasket 16 x 22 x 2.0
Item no. 6462-16-22
-  Ø gasket 16.7 x 24 x 1.5 mm
Item no. 6464-016-724

Daewoo

-  Ø gasket 14 x 20 x 1.5 mm
Item no. 6460-14-20

Daihatsu

-  Ø gasket 12 x 24 x 2 mm
Item no. 6464-012-242
Original no. 90430-12028

Ford

-  Ø screw M14 x 1.5 x 16 mm
Item no. 6243-14-15
-  Ø sealing ring yellow gv 16.7 x 24 x 2 mm
Item no. 6464-16-24
-  Ø gasket 14 x 22 x 2 mm
Item no. 6464-14-22
Original no. 1454118
-  Screw Ø including sealing ring M12 x 1.75 x 28.5 mm
Item no. 6243-012-15
Original no. 3051079
-  Ø gasket 13 x 22.5 x 3 mm
Item no. 6464-128-225
-  Ø screw M14 x 1.5 x 21 mm
Item no. 6243-14-159
-  Ø plastic, including sealing ring
Item no. 6243-30-2
-  Sealing ring Ø 30 x 3.0 mm
Item no. 6243-30-3

NEU

NEU

Honda



Ø gasket 14 x 22 x mm
Item no. 6464-114-22

Hyundai



Ø gasket 14 x 19 x 2.2 mm
Item no. 6464-14-19
Original no. MD050317

Jaguar



Ø screw M14 x 1.5 x 21 mm
Item no. 6243-14-159



Ø gasket 13 x 22.5 x 3 mm
Item no. 6464-128-225

Kia



Ø gasket 14 x 19 x 2.2 mm
Item no. 6464-14-19
Original no. MD050317

Land-Rover



Ø screw M14 x 1.5 x 16 mm
Item no. 6243-14-15



Screw Ø yellow gv M14 x 1.5 x 16 mm
Item no. 6243-014-15
Original no. 1454117/6732529



Ø sealing ring yellow gv 16.7 x 24 x 2 mm
Item no. 6464-16-24

Mazda



Ø gasket 14 x 20 x 1.5 mm
Item no. 6460-14-20

Mitsubishi



Ø gasket 14 x 19 x 2.2 mm
Item no. 6464-14-19
Original no. MD050317

Mini



Screw including sealing ring M14 x 1.5 x 20 mm
Item no. 6242-12-15
Original no. 11137513050

Mercedes Benz



Ø screw M14 x 1.5 x 24 mm
Item no. 6242-14-15
Original no. 6019970230



Ø gasket 14 x 20 x 1.5 mm
Item no. 6460-14-20



Ø screw M12 x 1.5 x 12 mm
Item no. 6241-12-15
Original no. 29973430



Ø gasket 12 x 17 x 1.5 mm
Item no. 6464-014-15

Nissan



Ø gasket 12 x 17 x 3 mm
Item no. 6464-11-17
Original no. 1102601M02

Opel

-  Ø screw M14 x 1.5 x 12 mm
Item no. 6242-014-15
Original no. 652475
-  Ø gasket 14 x 20 x 1.5 mm
Item no. 6460-14-20
-  Ø screw M14 x 1.5 x 10.5 mm
Item no. 6243-14-160
-  Ø gasket 18 x 22 x 2 mm
Item no. 6464-18-2
-  Ø screw M12 x 1.75 x 25 mm
Item no. 6243-12-160
Original no. 652736/652454
-  Ø gasket 11 x 21 x 2.5 mm
Item no. 6464-011-212
-  Ø screw M18 x 1.5 x 21 mm
Item no. 6243-18-15
Original no. 652950
-  Ø gasket 15.5 x 26 x 2.5 mm
Item no. 6464-185-26



Peugeot

-  Ø screw M10 x 1.25 x 13 mm
Item no. 6243-10-22
Original no. 311.29
-  Ø gasket 10.5 x 20.5 x 2 mm
Item no. 6464-10-10
Original no. 0313.33
-  Ø screw M18 x 1.5 x 16 mm
Item no. 6243-018-22
Original no. 770305077
-  Ø gasket M18 x 24 x 2.0
Item no. 6462-18-24
-  Ø screw M14 x 1.5 x 12.5 mm
Item no. 6243-014-22
-  Ø gasket 14 x 21 x 2.0
Item no. 6462-14-21

Porsche

-  Ø gasket 22 x 27 x 1.5 mm
Item no. 6460-22-27

Rover

-  Ø screw M12 x 1.5 x 18 mm
Item no. 6243-12-15
Original no. 11131273093
-  Ø gasket 12 x 17 x 1.5 mm
Item no. 6463-12-18

Renault

-  Ø screw M16 x 1.5 x 13 mm
Item no. 6243-016-22
Original no. 7903075033
-  Ø gasket 16 x 22 x 2.0
Item no. 6462-16-22
-  Screw with magnet M16 x 1.5 x 20.5 mm
Item no. 6243-160-22
Original no. 7703075012
-  Ø gasket M18 x 24 x 2.0
Item no. 6462-18-24
-  Ø screw M18 x 1.5 x 16 mm
Item no. 6243-018-22
Original no. 770305077
-  Ø gasket M18 x 24 x 2.0
Item no. 6462-18-24

Saab

 Screw Ø yellow gv M14 x 1.5 x 16 mm
Item no. 6243-014-15
Original no. 1454117/6732529

 Ø gasket 15 x 24 x 2 mm
Item no. 6464-15-15
Original no. 109132937

 Ø screw M14 x 1.5 x 16 mm
Item no. 6243-14-15

Seat

 Ø gasket 22 x 27 x 1.5 mm
Item no. 6460-22-27

 Screw Ø including sealing ring M14 x 1.5 x 22 mm
Item no. 6243-14-161

Skoda

 Ø screw M14 x 1.5 x 12 mm
Item no. 6242-014-15
Original no. 652475

 Ø gasket 14 x 20 x 1.5 mm
Item no. 6460-14-20

 Screw Ø including sealing ring M14 x 1.5 x 22 mm
Item no. 6243-14-161

Subaru

 Ø gasket 20 x 26 x 2 mm
Item no. 6464-20-15
Original no. 11126AA000

Suzuki

 Ø gasket 14 x 20 x 1.5 mm
Item no. 6460-14-20

Toyota

 Ø gasket 12 x 24 x 2 mm
Item no. 6464-012-242
Original no. 90430-12028

Volvo

 Ø gasket 18 x 24 x 1.5 mm
Item no. 6463-18-24

VW

 Ø screw M14 x 1.5 x 12 mm
Item no. 6242-014-15
Original no. 652475

 Ø gasket 14 x 20 x 1.5 mm
Item no. 6460-14-20

 Ø screw M14 x 1.5 x 17.5 mm
Item no. 6240-14-151

 Ø gasket 14 x 20 x 1.5 mm
Item no. 6460-14-20

 Screw Ø including sealing ring M14 x 1.5 x 22 mm
Item no. 6243-14-161

 Ø plastic, including sealing ring M14 x 1,5 x 22 mm
Item no. 6243-30-1
Original no. 06L103801

NEU

Vehicle body repair



01

Multipurpose primer

1K-Multi-Connector

- ▶ Item no. 2893-900 Light grey
- ▶ Contents: 400 ml
- ▶ Packing unit: 12



- ▶ Item no. 2893-900-20 Dark grey
- ▶ Contents: 400 ml
- ▶ Packing unit: 12



▶ **Product description**

- Recoatable without sanding
- With fan spray head
- Substrates: Galvanised sheet steel and aluminium, plastic, wood, etc.
- Particularly suitable for protecting the edges of filled areas
- Ideal for all difficult substrates, also suitable for plastic and wood

02

Aluminium undercoat

Alloy

- ▶ Item no. 2893-881
- ▶ Contents: 400 ml
- ▶ Packing unit: 12

▶ **Product description**

- Heat-resistant corrosion protection up to +600°C
- Weldable
- Overpaintable
- Protects new sheet metal against corrosion

03

Zinc primer

Galva 97

- ▶ Item no. 2893-880
- ▶ Contents: 400 ml
- ▶ Packing unit: 12

▶ **Product description**

- Protects new sheet metal against rusting
- Weldable
- Abrasion resistant after drying
- High corrosion protection
- High percentage of active substances

03

Zinc-aluminium undercoat

Galva 97 Silver

- ▶ Item no. 2893-890
- ▶ Contents: 400 ml
- ▶ Packing unit: 12

▶ **Product description**

- Ideal for colour matching to galvanised sheet metal
- Protects new sheet metal against corrosion
- Weldable
- Abrasion resistant after drying
- High corrosion protection
- High percentage of active substances



01



02



03



04

GALVA PROTECTS NEW SHEET METAL AGAINST RUST!



01

Two-Component Primer Filler

2K Rapid Filler

- ▶ Item no. 2893-905
- ▶ Contents: 400 ml
- ▶ Packing unit: 6

▶ **Product description**

- Isocyanate-free
- Very rapid curing after 1 hour at 20°C
- or after 15-20 mins. at 60°C
- Universal use on old sanded paintwork and metallic substrates
- Simple and quick to use
- Very high filling capacity
- Very good adhesion on bright steel/plate
- Can be overpainted with any current 1K and 2K covering-paint systems

02

Primer filler

2-component epoxy primer filler

- ▶ Item no. 2800-760
- ▶ Contents: 400 ml
- ▶ Packing unit: 6

▶ **Product description**

- Gloss level: matt
- Colour: beige
- Long-lasting corrosion protection on all surfaces, e.g. zinc, aluminium, steel, etc.
- Proportion of solid particles: 50-53% by weight on diluted paint (without propellant gas)

03

Thick film filler

One-component multi filler

- ▶ Item no. 2893-902
- ▶ Contents: 400 ml
- ▶ Packing unit: 10

▶ **Product description**

- High filling volume
- Easy to sand
- Quick drying
- With cone spray head



04

Pistol grip

- ▶ Item no. 2893-900-2



05

Fan nozzle

- ▶ Item no. 2893-900-3



06

NEU

06

Sealable lid

for used aerosol cans

- ▶ Item no. 2897-999



01



02



03

04

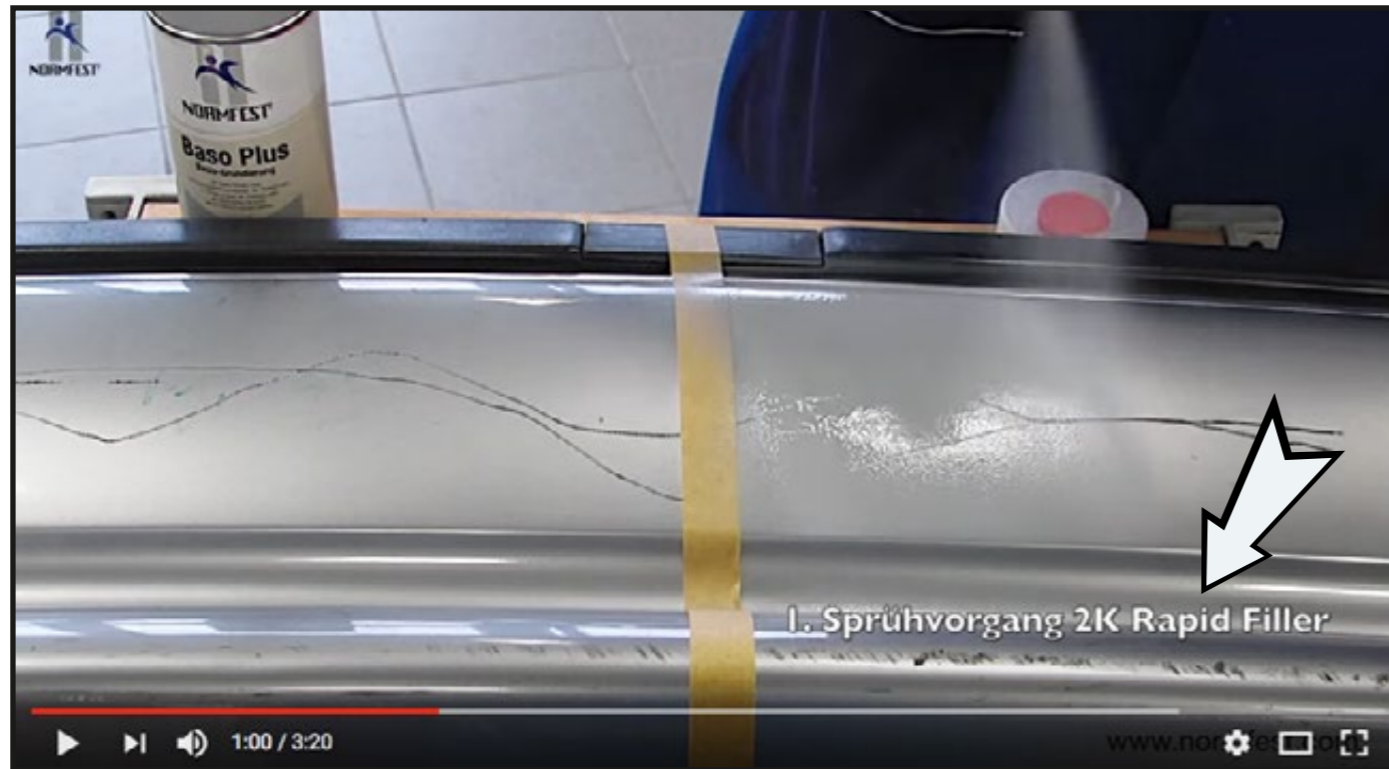

01

Base primer

Baso Plus

- ▶ Item no. 2893-889
- ▶ Contents: 400 ml
- ▶ Packing unit: 24

▶ **Product description**

- High filling properties
- Improved coverage due to increased number of pigments
- Temperature resistant up to 100°C
- Overpaintable with nitro, acrylic and water-based paints
- Fan spray head enables vertical and horizontal application

**THE 2-C RAPID FILLER
CAN BE FOUND ON PAGE 5
OF THIS CHAPTER!**



01



02

Rust-Stop Primer

Rednox

- ▶ Item no. 2893-888
- ▶ Contents: 400 ml
- ▶ Packing unit: 12

- ▶ Item no. 2893-888-25
- ▶ Contents: 2.5 kg
- ▶ Packing unit: 1

▶ **Product description**

- Quick drying
- Weldable
- Overpaintable
- Sprayable

02



03

Rust converter

Rostinator

- ▶ Item no. 2893-903
- ▶ Contents: 400 ml
- ▶ Packing unit: 12

▶ **Product description**

- Active pigments turn rust into iron sulphide
- Forms a permanent weatherproof and moisture-resistant protective layer
- Drying time: 14 hours
- Compatible with all Normfest primers

03



04

Welding Primer

Elox Plus

- ▶ Item no. 2893-906
- ▶ Contents: 400 ml
- ▶ Packing unit: 12

▶ **Product description**

- 1K acrylic base
- Very good corrosion protection
- Can be over welded over
- Very good ignitability & conductivity
- Suitable for iron and steel
- Quick drying
- Visually matches stainless-steel parts



04



01

Underseal, can be painted over

Bottom Guard Recoat

- ▶ Item no. 2892-881
- ▶ Contents: 500 ml
- ▶ Packing unit: 12



▶ Product description

- Provides optimum underbody protection with anti-rust and anti-corrosion properties
- Improves sound insulation
- Rust-protection spray dries quickly and is extremely resistant to abrasion
- Has very good adhesion to all substrates, such as bumpers / front and rear aprons
- The underbody spray can be overpainted after 60-90 minutes using two-component and basic paints

02

Underseal, recoatable

Bottom Guard Recoat

- ▶ Item no. 2892-882
- ▶ Contents: 1000 ml
- ▶ Packing unit: 12



▶ Item no. 2892-883

- ▶ Contents: 1000 ml
- ▶ Packing unit: 12



▶ Product description

- Provides optimum underbody protection with anti-rust and anti-corrosion properties
- Outstanding sound insulation
- Extremely resistant to abrasion
- Quick drying
- Can be overpainted with current two-component and basic paints after approx. 60-90 minutes (at 20°C, 65% rel. air humidity)
- Rubber base



03

Water-based underbody protection

Can be painted over

Bottom Guard Protect

- ▶ Item no. 2892-995
- ▶ Contents: 1000 ml
- ▶ Packing unit: 12

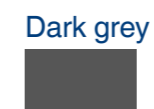

▶ Product description

- Dark grey
- Water-based
- Quick-drying
- With corrosion protection
- Can be painted over with conventional 2K acrylic paints, base paints and water-based paints
- Can be sanded after drying
- Extremely elastic and durable after hardening
- Temperature resistant from -25°C to +120°C
- Low-odour
- Touch-dry (20°C, 65% RH) after approx. 90-120 minutes
- Fully hardened depending on the layer thickness at (20°C, 65% RH) in approx. 7 days



01

Wax-based underbody protection

Bottom Guard Wax

- ▶ Item no. 2892-994-1
- ▶ Contents: 1000 ml
- ▶ Packing unit: 12

Transparent



- ▶ Item no. 2892-994-2
- ▶ Contents: 1000 ml
- ▶ Packing unit: 12

Black



- ▶ Item no. 2892-994-3
- ▶ Contents: 500 ml
- ▶ Packing unit: 12

Transparent



▶ **Product description**

- Corrosion protection even with thin material layer
- High creep capacity & self-healing effect
- Thermally stable from -25°C to +180°C
- Can be used on PVC underbody coatings
- No drips one hour after application
- Touch-dry: approx. 2.5 hours
- Completely dry: approx. 24 hours

02

Underbody protection (cannot be painted over)

Bottom Guard

- ▶ Item no. 2892-990
- ▶ Contents: 1,000 ml black
- ▶ Packing unit: 12

Black



▶ **Product description**

- Cannot be overpainted
- Contains solvents
- Bitumen base
- After curing, thanks to its combination of raw materials, the coating provides abrasion-resistant, permanently elastic corrosion protection with high resistance to ageing, which does not become brittle even when cold.

03

Body protection

Long-Life

- ▶ Item no. 2892-997-1
- ▶ Contents: 400 ml
- ▶ Packing unit: 12

▶ **Product description**

- Displaces water
- Creep-capable
- Quick drying
- Thermally stable from -50°C to +90°C
- Extremely abrasion resistant
- For sealing large areas of bodywork

01



02



03





01
Water-based cavity protection
Protector Protect

- ▶ Item no. 2892-999
- ▶ Contents: 1000 ml
- ▶ Packing unit: 12

- ▶ Technical specifications
 - Water based & environmentally friendly
 - Capable of extreme creep
 - Outstanding corrosion resistance
 - Low odour
 - Almost tack-free after flashing off
 - Almost transparent when dry
 - Processing tools can be cleaned with water directly after working
 - Very low VOCs (volatile organic compounds, a collection of light materials containing carbon)

NEU



01

02
Cavity protection
Protector

- ▶ Item no. 2892-998
- ▶ Contents: 1000 ml
- ▶ Packing unit: 12

- ▶ Product description
 - Thermally stable from -25°C to +160°C
 - Designed to protect and seal pillars, door sills, areas of the vehicle interior, etc..
 - Excellent penetration properties

03
Cavity protection
Protector

- ▶ Item no. 2892-997
- ▶ Contents: 400 ml
- ▶ Packing unit: 15

- ▶ Product description
 - Thermally stable from -30°C to +90°C
 - The hose supplied ensures application even in hard-to-reach cavities
 - Facilitates optimal wetting of areas to be protected
 - Contains NO silicone!
 - Transparent



02



03

01

Pressure cup spray gun
for 1000 ml screw-top containers

▶ Item no. 2891-106-841

▶ Product description

- Ideal for use of Bottom-Guard and Protector
- Wide range of structures can be sprayed
- Teflon seals
- Suitable for metal



02

Body cavity spray hose set
For pneumatic pressure cup spray gun

▶ Item no. 2891-106-842

▶ Product description

- Specially designed for Protector
- Hose diameter: 6 mm
- Hose length: 98 cm (with handle, incl. adapter), 116 cm (without handle, incl. adapter)



03

UBS gun
Including nozzle and feed tube

▶ Item no. 2892-880

▶ Product description

- Quick & easy to assemble
- Accurately adjustable spray pattern
- Quick & easy to change
- No cleaning required
-
- Contents
- 1 x gun
- 2 x nozzles
- 1 x feed tube



04

Nozzle set
For UBS gun (article no. 2892-880)

▶ Item no. 2892-880-1

▶ Product description

- Nozzle set for UBS gun (article no. 2892-880)
- Content:
- 3 x nozzles
- 3 x feed tubes





01

Chassis glue & sealing compound Basis: Polyurethane

Proton Protect

- ▶ Item no. 2893-225-1 White 
- ▶ Contents: 300 ml
- ▶ Packing unit: 12

- ▶ Item no. 2893-225-2 Black 
- ▶ Contents: 300 ml
- ▶ Packing unit: 12

- ▶ Item no. 2893-225-3 Grey 
- ▶ Contents: 300 ml
- ▶ Packing unit: 12

▶ **Product description**

- for primed and painted metals, aluminium, wooden materials and thermosetting plastics, standard structural mineral substrates
- Can be overpainted once cured
- Adheres to a wide variety of materials
- Good resistance to moisture and weathering
- Thermally stable from -40°C to +90°C (to +120°C in the short term)
- CE mark to EN 15651 Part 1

02

Round nozzle

For aluminium cartridge, embossed, length: 8.2 cm

- ▶ Item no. 2891-02-25

02



01

03

UV-resistant chassis glue & sealing compound

Basis: MS polymer

Krypton Protect

- ▶ Item no. 2893-226-1 White 
- ▶ Contents: 310 ml
- ▶ Packing unit: 12

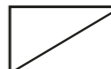
- ▶ Item no. 2893-226-2 Transparent 
- ▶ Contents: 310 ml
- ▶ Packing unit: 12

- ▶ Item no. 2893-226-3 Grey 
- ▶ Contents: 310 ml
- ▶ Packing unit: 12

- ▶ Item no. 2893-226-4 Black 
- ▶ Contents: 310 ml
- ▶ Packing unit: 12

▶ **Technical specifications**

- Good adhesion to glass, many metals (zinc, aluminium, steel), paints, primers and wooden materials
- Resistant to moisture and weathering
- Good adhesion to duroplastics and thermoplastics (apart from PE, PP, PTFE) and mineral substrates
- Temperature stability: -40°C to +90°C
- Skin formation: 20 minutes
- Curing: 3 mm/24 h > Curing: 3 mm/24 h
- Shore hardness A: 60
- Elongation at tear: 300%
- Tensile strength: 1.9 N/mm²
- Tear-propagation resistance: 12 N/mm

04

Round nozzle

Basis: polyurethane

- ▶ Item no. 2891-02-26

04



03

SEALING COMPOUNDS FROM OUR PROTECT SERIES!



01

UV-resistant and sprayable joint sealant
Basis: Mixed polymer
 Flexon Protect

- ▶ Item no. 2893-310
- ▶ Contents: 310 ml
- ▶ Packing unit: 12

- ▶ Item no. 2893-311
- ▶ Contents: 310 ml
- ▶ Packing unit: 12

Grey



Black



▶ **Technical specifications**

- Elastic
- Can be sanded
- Silicone free
- Adheres to many metals (zinc, aluminium, steel), paints, primers, glass, wood, plastics (apart from PE, PP, PTFE) and mineral substrates
- Temperature stability: -40°C to +80°C, to +120°C in the short term
- Skin formation after 20 minutes
- Can be overpainted (recommendation: It should be overpainted within the first 2 hours otherwise there may be difficulties in adhesion with some paint systems)

**ELASTIC,
 CAN BE SANDED,
 SILICONE FREE!**

NEU



01

02

Body adhesive
 Pluton

- ▶ Item no. 2893-223-4
- ▶ Contents: 280 ml
- ▶ Packing unit: 12



▶ **Product description**

- High strength after 30 mins.
- Adheres without a primer to steel, aluminium, galvanized plate, GFRP and plastics
- Can be overpainted
- Permanently thermally stable up to +80°C
- Can be welded



02

03



03

For plastic cartridges

For use with body sealing compounds, windscreen adhesives and sprayable seam sealants

- ▶ Item no. 2891-03-1



05

05

Wing nozzle

For achieving wide and flat sealing compound seams

- ▶ Item no. 2891-02-27

04



04

Square spatula

for Pluton

- ▶ Item no. 2893-223-38

▶ **Product description**

- Length: Mixer rod 23 cm
- Diameter at tip: approx. 0.5 cm
- Diameter of adapter: 2.2 cm

06



06

Cartridge opener

- ▶ Item no. 2891-02-50

01

Pneumatic cartridge gun

Ideal for use with sprayable seam sealants, e.g. Flexon (2893-300)

► Item no. 2891-05

► Product description

- Content:
- 1 x pneumatic cartridge gun
- 1 x nozzle set (10 long nozzles, 20 short nozzles)
- 1 x spare nozzle cap



01

02

Spare small spray tubes

For pneumatic cartridge gun (2891-05)

► Item no. 2891-051

► Product description

- Packaging unit: 30 pieces

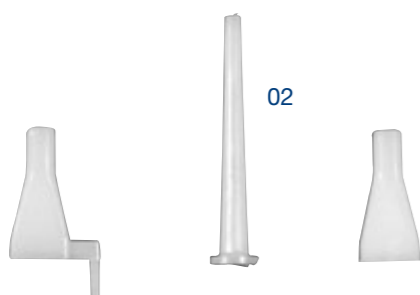

02

03

Brush

For body sealing compounds

► Item no. 4693-251-1

► Product description

- Model: 1.0"



03



04

Bonding-surface cleaner

Glue-Ex

- Item no. 2893-200-10
- Contents: 1000 ml
- Packing unit: 12

► Product description

- The ideal cleaner for cleaning surfaces before being stuck
- Can be used on all substrates in the automotive area, apart from plastics
- Transparent

05

Adhesive cleaner

HR 150

- Item no. 2700-36
- Contents: 150 ml
- Packing unit: 1

► Product description

- Cleans and simultaneously primes
- Ideal for pre-treating non-absorbent metal and plastic substrates



04



05



01
Plastics repair adhesive
Repos fast

- ▶ Item no. 2700-15
- ▶ Contents: 50 ml
- ▶ Packing unit: 2

- ▶ **Product description**
- For sticking PVC, GFRP, steel and aluminium
- The material is highly elastic
- Setting time: 90 seconds
- Can be sanded after roughly 15 minutes

02
Plastics repair adhesive
Repos fast

- ▶ Item no. 2700-16
- ▶ Contents: 25 ml
- ▶ Packing unit: 1

- ▶ **Product description**
- Setting time: 90 seconds
- Sandable after 60 minutes

03
Structural adhesive
Repos MMA

- ▶ Item no. 2700-20
- ▶ Contents: 50 ml
- ▶ Packing unit: 2

- ▶ **Product description**
- For sticking PVC, GFRP, steel and aluminium
- The material becomes rigid
- Thermally stable: -50°C to +120°C
- For the bonding of different substrates, such as: sun-visor holders, plastic cladding, carbon on steel, aluminium parts on steel substrates and much more
- Can be used without chemical or mechanical pre-treatment
- At 35 Mpa has enormous combined tension and shear resistance
- No solvents or volatile organic compounds
- Processing temperature: +10°C to +30°C
- Touch dry after approx. 15 minutes
- Cured in approx. 24 hours
- Oil resistant



04
Plastics repair adhesive
Repos

- ▶ Item no. 2700-10
- ▶ Contents: 50 ml
- ▶ Packing unit: 2

- ▶ **Product description**
- For sticking PVC, GFRP, steel and aluminium
- The material is highly elastic
- Setting time: 5 minutes
- Can be sanded after roughly 90 minutes



REPOS MMA LETS CARS FLY. WATCH THE VIDEO!



01

Light-pressure metal gun
for plastic repair adhesive

► Item no. 2700-71

► Product description

- Easy to squeeze
- Robust plastic/metal casing
- Ready to use quickly and easily



01

02

Cartridge gun
For plastic repair adhesive

► Item no. 2700-70

► Product description

- Quickly ready for use
- For 50 ml cartridges with two tubes
- Made from plastic



02

03

Mixer rod
For plastic repair adhesive

► Item no. 2700-40

► Product description

- Suitable for Repos plastic repair adhesive
- Improved mixing ratio due to new static mixing fabric
- Length: 15 cm



03

04

Square spatula
Suitable for Repos, Repos Fast and Repos MMA

► Item no. 2700-42

► Product description

- Suitable for Repos (2700-10), Repos Fast (2700-15) and REPOS MMA (2700-20). A very good mixing ratio is achieved through the new static mixer fabric



04

05

Reinforcing tape
Dimensions: 50mm x 4.0m

► Item no. 2700-60

► Product description

- For stabilizing the repair surface
- 50 mm x 4.0 m



05

06

Contour foil
Dimensions: 125mm x 3.6m

► Item no. 2700-50

► Product description

- For simple smoothing of the adhesive mass
- 125 x 3.6 mm



06

01

Plastic welding system

Repotec

► Item no. 2701-999-999

► Product description

- A welding wire for every plastic
- No laborious testing of the plastic type
- Temperature/ air volume combinations can be saved in the device depending on the application
- Ready in 30 - 60 minutes
- Material costs below €5 per repair
- Immediately ready for smoothing and painting
- Extremely durable
- Contents:
- 1 x vehicle repair nozzle for plastic welding (article no. 2701-10)
- 1 x 9 mm reducing nozzle for hot-air gun (article no. 2701-11)
- 1 x temperature shield for hot-air gun (article no. 2701-12)
- 1 x set of EEA/EVA welding wire (20 items) (art. no. 2701-2)
- 1 x set of EEA/EVA wire cloth (10 items) (art. no. 2701-30)
- 1 x 2300 W hot-air gun (article no. 8697-000-991)



01

02

Dent repair set

Bodytec I

► Item no. 8714-999-999

► Product description

- Professional external dent repairs
- Disassembly of coverings not required
- Content: 13 pieces
- 1 x 2000-640-40 Microfiber cloth blue 40x40 cm
- 1 x 2893-200-10 Glue-Ex 1000 ml
- 1 x 2897-323 Terpanol Power 400 ml
- 1 x 2897-325 Arctic 200 ml
- 1 x 8714-600 Bodytec repair bridge
- 1 x 8714-607-1 Glue gun 230V / 200W
- 2 x 8714-611-7 Glue sticks set black PU: 5
- 1 x 8714-612-6 Nylon striker pin diam. 13 mm
- 1 x 8714-614-2 Pull tabs set 16 mm PU: 2
- 1 x 8714-614-3 Pull tabs set 21 mm PU: 2
- 1 x 8714-614-4 Pull tabs set 27 mm PU: 2
- 1 x 8714-614-5 Pull tabs set 32 mm PU: 2

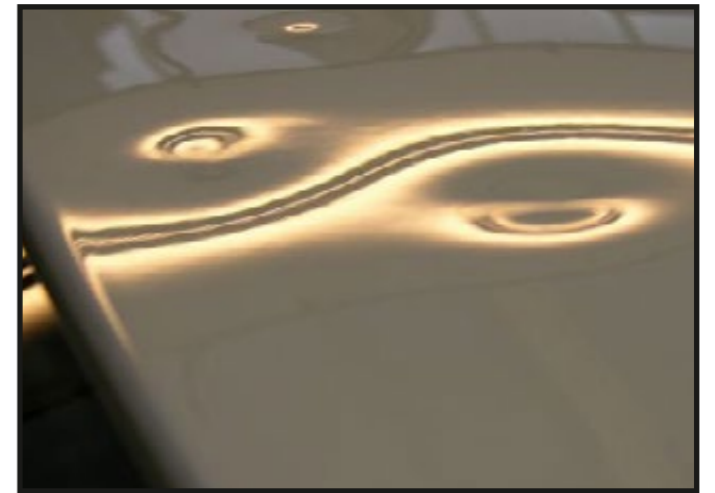

02

01

Inspection lamp for dent repairs

Incl. suction base

▶ Item no. 8714-610

▶ Product description

- Flexible use
- Can also be used as a hand lamp via the detachable flexible arm
- Paint-protecting 120 mm-diameter suction foot
- 300 mm long flexible arm with star handle
- Protects eyes thanks to prismatic protective glass

- 220/240 Volt with automatic switch-off
- 50/60 Hz
- 900 Lumen
- 210 mm light length
- Width: 38.5 mm
- Length: 65 mm
- 11 Watt fluorescent lamp
- 5m supply cable



02

Repair bridge

▶ Item no. 8714-600

▶ Product description

- Flexible feet
- Material: metal



03

Hot melt gun

Electronically controlled

▶ Item no. 8714-607-1

▶ Product description

- Adhesive area firm and resilient after around just 2 min.
- High melting capacity
- Interchangeable nozzle
- Electronic temperature control thanks to modern PTC heating technology
- Easy handling thanks to mechanical feed device for glue sticks
- In attractive plastic case



04

Mushroom repair patches

Colour: blue, Contents: 2 pieces

▶ Item no. 8714-614-2
▶ Diameter 16 mm, blue

▶ Item no. 8714-614-3
▶ Diameter 21 mm, blue

▶ Item no. 8714-614-4
▶ Diameter 27 mm, blue

▶ Item no. 8714-614-5
▶ Diameter 32 mm, blue



05

Nylon striker pin

Ø 13 mm

▶ Item no. 8714-612-6



06

Glue sticks

Colour: black, content: 5 sticks

▶ Item no. 8714-611-7



01

Dent repair set

Bodytec II

▶ Item no. 8714-999-998

▶ Product description

- In addition to the increased repair speed compared to Bodytec System I, it also enables the repair of large dents
- Furthermore, the flexible pull tabs (orange) can be moulded to various dent shapes
- Disassembly of covering not required

- Content: 18 pieces

- 1 x 2000-640-40 Microfiber cloth blue 40x40 cm
- 1 x 2893-200-10 Glue-Ex 1000 ml
- 1 x 2897-323 Terpanol Power 400 ml
- 1 x 2897-325 Arctic 200 ml
- 1 x 8714-601 Bodytec body dent puller
- 1 x 8714-606 Glue gun 230V / 200W
- 2 x 8714-611-9 Glue sticks set black PU: 5
- 1 x 8714-612-6 Nylon striker pin, diameter 13MM
- 1 x 8714-614-10 Pull tabs set, 40 mm, orange, PU: 22
- 1 x 8714-614-11 Pull tabs set 50x30 mm orange, PU: 2
- 1 x 8714-614-2 Pull tabs set 16 mm, PU: 2
- 1 x 8714-614-3 Pull tabs set 21 mm, PU: 2
- 1 x 8714-614-4 Pull tabs set 27 mm, PU: 2
- 1 x 8714-614-5 Pull tabs set 32 mm, PU: 2
- 1 x 8714-614-6 Pull tabs set 35 mm, BLUE, PU: 2
- 1 x 8714-614-7 Pull tabs set 40 mm, blue, PU: 2
- 1 x 8714-614-8 Pull tabs set 50x30 mm blue, PU: 2
- 1 x 8714-614-9 Pull tabs set 35 mm, orange, PU: 2



01

02

Body dent remover

▶ Item no. 8714-601

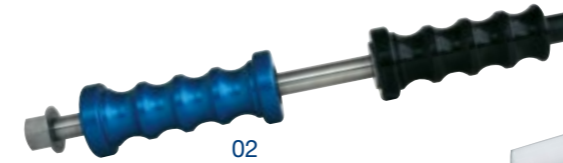

02

03

Nylon striker pin

Ø 13 mm

▶ Item no. 8714-612-6



03

04

Glue sticks HD

Colour: blue, content: 5 sticks

▶ Item no. 8714-611-9



04

05

Pull tabs

Colours: blue and orange

▶ Item no. 8714-614-2
▶ Diameter 16 mm, blue

▶ Item no. 8714-614-3
▶ Diameter 21 mm, blue

▶ Item no. 8714-614-4
▶ Diameter 27 mm, blue

▶ Item no. 8714-614-5
▶ Diameter 32 mm, blue

▶ Item no. 8714-614-6
▶ Diameter 35 mm, blue

▶ Item no. 8714-614-7
▶ Diameter 40 mm, blue

▶ Item no. 8714-614-8
▶ 50 x 30 mm, blue

▶ Item no. 8714-614-9
▶ Diameter 35 mm, orange (mouldable)

▶ Item no. 8714-614-10
▶ Diameter 40 mm, orange (mouldable)

▶ Item no. 8714-614-11
▶ 50 x 30 mm, orange (mouldable)



05

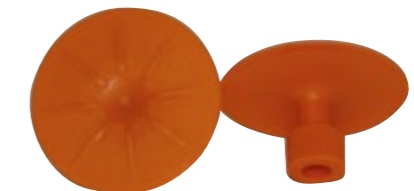



A GOOD CUT-OFF WHEEL IS MEGA IMPORTANT!



01

Cut off wheel
Snake Performance

► **Product description**

- Service life 20% higher than that of conventional cut off wheels
- Width of cut 1.0 mm
- Clean cut surfaces, less burr
- Less waste and dust
- Low thermal stress
- Suitable for plastics, high-alloyed sheets and steel
- Fast cutting action
- High break resistance
- Reduced machine load
- Max. 13,300 rpm



01

Item no.	Ø	Thickness	Bore hole	Packing unit
4667-063-1	63 mm	1,0 mm	6,0 mm	30
4667-115-1	115 mm	1,0 mm	22,2 mm	30
4667-125-1	125 mm	1,0 mm	22,2 mm	30

02

Cut off wheel
Twister

► **Product description**

- Width of cut 0.8 mm
- Suitable for high-strength thin sheet of the latest vehicle generation
- High flexibility
- Clean cut surfaces, less burr
- Suitable for plastics, thin high-alloyed sheets and steel
- Fast cutting action
- Less waste and dust
- Reduced machine load
- High break resistance
- Low thermal stress
- Max. 13,300 rpm
- Hole 22.2 mm
- Use with spacer disc



02

Item no.	Ø	Thickness	Bore hole	Packing unit
4667-115-8	115 mm	0,8 mm	22,2 mm	30
4667-125-8	125 mm	0,8 mm	22,2 mm	30

03

Cut-off wheel
Inox

► **Product description**

- consists of a very strong composite resin,
- which achieves very good stability with the cloth



03

Item no.	Ø	Thickness	Bore hole	Packing unit
4667-115-12	115 mm	1,2 mm	22,2 mm	30
4667-115-25	115 mm	2,5 mm	22,2 mm	30
4667-125-12	125 mm	1,2 mm	22,2 mm	30
4667-125-25	125 mm	2,5 mm	22,2 mm	30
4667-180-25	180 mm	1,6 mm	22,2 mm	30
4667-230-25	230 mm	1,9 mm	22,2 mm	30
4667-060-20	60 mm	2,0 mm	6 mm	1
4667-100-1	Clamping bolts			1



01
Roughing disc
Inox



Item no.	Ø	Thickness
4669-063-60	63 mm	6,0 mm
4669-115-60	115 mm	6,0 mm
4669-125-60	125 mm	6,0 mm
4667-100-1	Work arbor for 6mm drill hole	

02
Vulcanised fibre discs

Item no.	Ø	Graining
4665-115-24	115 mm	24
4665-115-36	115 mm	36
4665-115-40	115 mm	40
4665-115-60	115 mm	60
4665-115-80	115 mm	80
4665-178-24	178 mm	24
4665-178-36	178 mm	36
4665-178-40	178 mm	40



03
Rubber plate for Vulkan fibre discs

Item no.	Ø
4666-115	115 mm
4666-178-14	178 mm

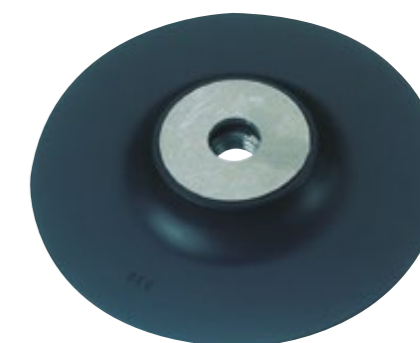

04
Vanish
Roughing disc and fan-type grinding wheel

- ▶ Product description
- Clear view of the surface being treated enables precise work and constant inspection
- Combines the sanding performance of roughing discs with the speed of a fan-type grinding wheel
- 25% less temperature development compared to conventional roughing discs
- Suitable for working of weld seams or removing rust, paint, etc.
- Max. 13,300 rpm

Item no.	Ø	Graining
4670-115-36	115 mm	36





01
Grinding mop plate
 Heavy Duty

- ▶ **Product description**
- 100% pure zirconium corundum
- 72 grinding discs
- Very robust Y-shaped polyester support
- Very fast and aggressive cutting
- Very long service life
- Angled shape



Item no.	Ø	Graining
4663-115-040	115 mm	40
4663-115-060	115 mm	60
4663-115-080	115 mm	80
4663-125-040	125 mm	40
4663-125-060	125 mm	60
4663-125-080	125 mm	80



02
Mini serrated grinding discs
 Flexloc

- ▶ **Product description**
- High-performance cutting
- Good service life
- Very flexible thanks to angled discs
- Ideal for hard-to-reach places
- Ideal for:
- Removing weld seams / spots
- Removing rust
- Removing old paint and primers
- Deburring sheets

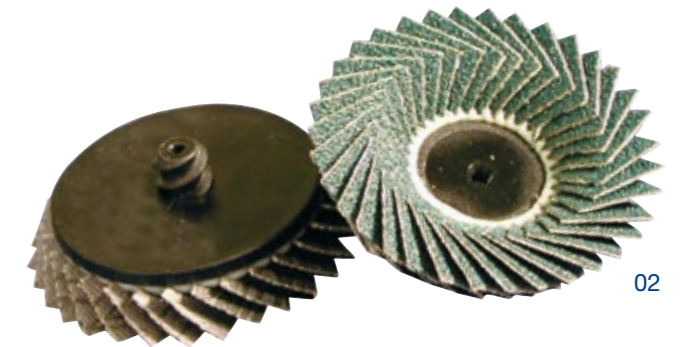

Item no.	Graining	Max. rpm
Ø 50 mm		
4679-50-36	36	30.000
4679-50-60	60	30.0000
4679-50-80	80	30.0000
Ø 75 mm		
4679-75-36	36	20.000
4679-75-60	60	20.000

01

Sanding mop disc
bevelled shape

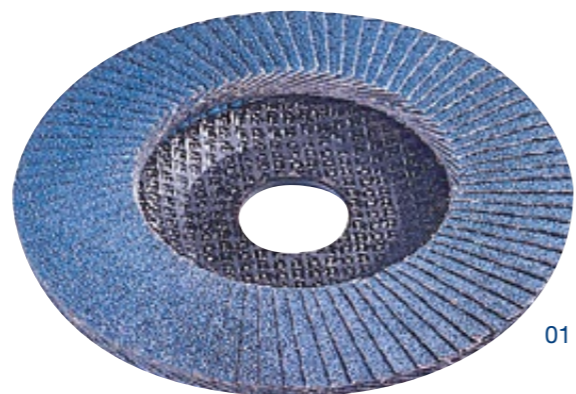

Item no.	Ø	Graining
4662-115-036	115 mm	36
4662-115-040	115 mm	40
4662-115-060	115 mm	60
4662-115-080	115 mm	80
4662-125-036	125 mm	36
4662-125-040	125 mm	40
4662-125-060	125 mm	60
4662-125-080	125 mm	80

02

Nylon fabric abrasive discs / angle grinder

Item no.	Ø
4585-1-115	115 mm

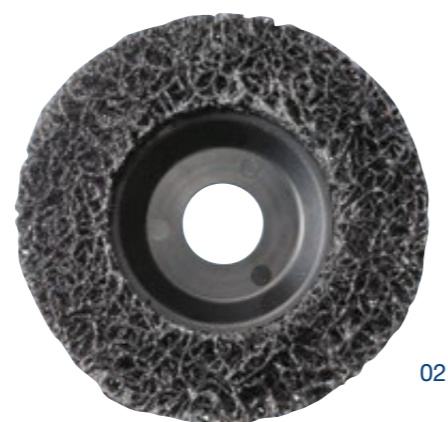

03

Nylon fabric abrasive discs / drill

- Product description
- Black grinding wheel consisting of nylon fabric
- A grain resin is additionally applied to this fabric

Item no.	Ø	
4585-1-100	100 mm	Max. 8,000 rpm
4585-1-150	150 mm	Max. 5,500 rpm

Tensioning spindle

4585-110-01	6 mm for 4585-1-100
4585-115-01	8 mm for 4585-1-150



04

Nylon fabric grinding plate

Red, hard, cool grind

- Product description
- Very fast and aggressive cleaning
- Extremely long service life thanks to ceramic-corundum grain
- No geometric change to surface
- No corrosive residues on the workpiece surface

Item no.	Ø	Holder
4585-2-100	100 mm	for drill
4585-2-115	115 mm	for angle grinder
4585-2-150	150 mm	for drill



01

Zircoloc

► **Product description**

- Minimal heat generation due to additives in the binding agent
- The fabric backing ensures high flexibility
- Ideal for:
 - Removing weld seams / spots
 - Removing rust
 - Removing old paint and primers

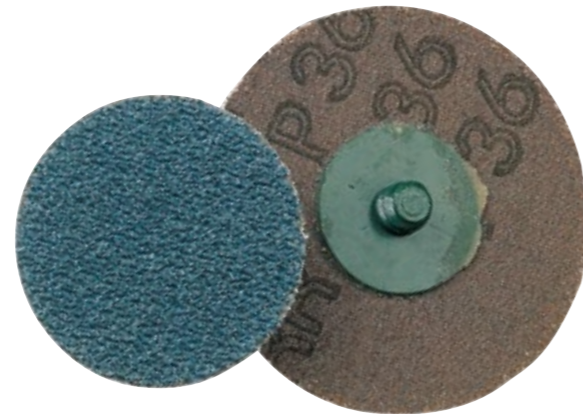

01

Item no.	Graining	Max. rpm
Ø 50 mm		
4679-02-24	24	30.000
4679-02-36	36	30.000
4679-02-60	60	30.000
4679-02-80	80	30.000
4679-02-120	120	30.000

Ø 75 mm		
4679-03-24	24	20.000
4679-03-36	36	20.000
4679-03-60	60	20.000
4679-03-80	80	20.000
4679-03-120	120	20.000

02

High-performance Zircoloc grinding discs

► **Product description**

- High-performance cutting
- Fast grinding
- Extremely long service life
- Low heat generation
- Little wear
- Colour: green
- Ideal for:
 - Removing weld seams / spots
 - Removing rust
 - Grinding off old paint and primer
 - Removing damage to aluminium rims



02

Item no.	Graining	Max. rpm
Ø 50 mm		
4679-04-24	24	30.000
4679-04-36	36	30.000
4679-04-60	60	30.000
4679-04-80	80	30.000
4679-04-120	120	30.000

Ø 75 mm		
4679-05-24		
4679-05-36	36	20.000
4679-05-60	60	20.000
4679-05-80	80	20.000
4679-05-120	120	20.000

01

BLAZE Nylon fabric polishing disc

► **Product description**

- Ceramic high-performance corundum
- Open structure
- High removal rate (coarse)
- Exceptional stand time
- Particularly flexible
- Can be used for the Normloc mounting system
- on various materials



01

Item no.	Model	Max. rpm
4585-3-50	Diameter 50 mm	15.500
4585-3-75	Diameter 75 mm	12.000

02

Blackloc

► **Product description**

- Extremely open structure ensures long service life
- Extremely low heat generation
- Ideal for removing loose rust, old paint and underbody protection



02

Item no.	Max. rpm
Ø 50 mm	
4679-47	30.000
Ø 75 mm	
4679-48	20.000

03

Fabric grinding disc

Sandloc

► **Product description**

- Extremely flexible fabric grinding discs with very low heat generation
- Ideal for sanding in tight spaces and curves
- Removing sealing compounds and any solid seal residues
- Sanding fillers
- Removing old paint and primers

Item no.	Model	Max. rpm
Ø 50 mm		
4679-22-50	Fine (blue)	30.000
4679-23-50	Medium (red)	30.000
4679-25-50	Coarse (yellow)	30.000
Ø 75 mm		
4679-22-75	Fine (blue)	20.000
4679-23-75	Medium (red)	20.000
4679-25-75	Coarse (yellow)	20.000
Ø 115 mm		
4679-25-115	Coarse (yellow)	10.000

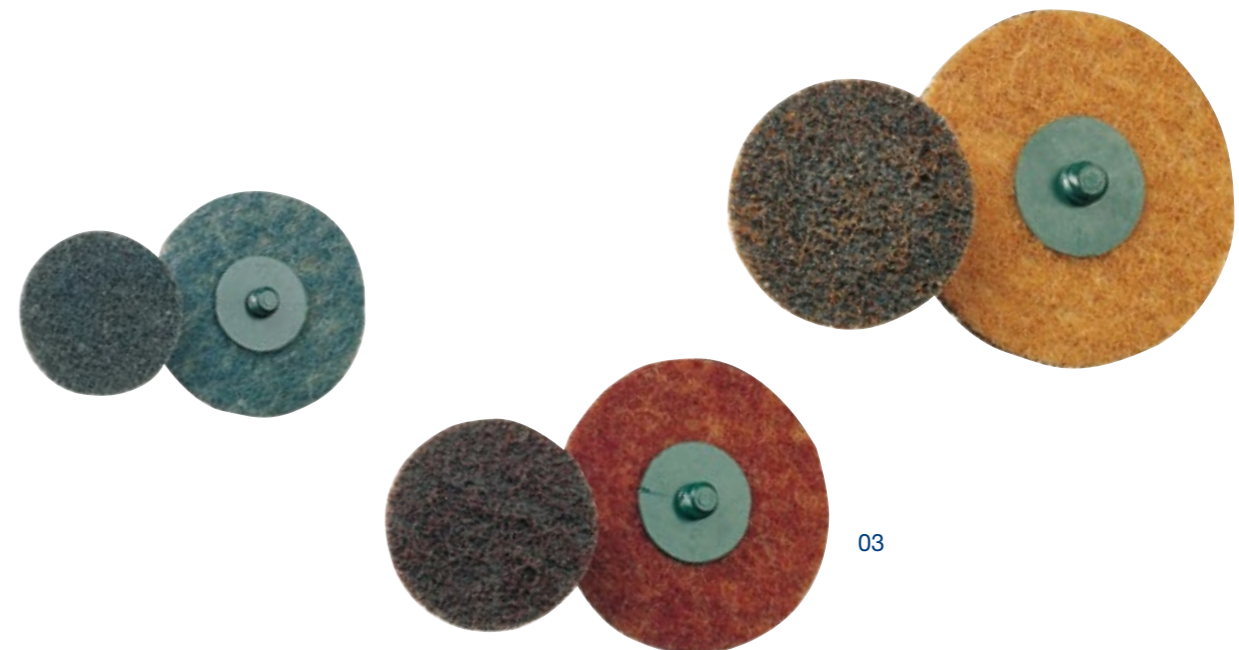

03

01

Mini one-hand right angle grinder

Low-noise and vibration-free

► Item no. 8696-1-80

► Product description

- Compressed air fitting: 1/4"
- Sound pressure: 83 dB/A
- Air pressure: 6.3 bar
- Weight: 0.8 kg
- Speed: 18,000 rpm
- Chuck: 6 mm
- Average air consumption: 220 l/min



01

02

Normloc reception system

Made from a hard polyurethane supporting disc

► Item no. 4679-90-94

► Diameter 30 mm, max. rpm: 40,000

► Item no. 4679-90-92

► Diameter 50 mm, max. rpm: 30,000

► Item no. 4679-90-93

► Diameter 75 mm, max. rpm: 20,000

► Item no. 4679-99-6

► Ø 6 mm incl. mounting shank



02

03

Required air connection 1/4"

► Item no. 8699-510-14



03

04

Adapter for 8696-1-80

► Item no. 4679-99-8



04



05

Bristle Disc 3M

► Product description

- Suitable for exposing weld spots and removing sealing compounds, underbody protection and solid seal residues



05

Item no.	Model	Max. rpm
Ø 50 mm		
4679-44	fine - white	25.000
4679-45	medium - yellow	25.000
4679-46	coarse - green	25.000
Ø 75 mm		
4679-46-75	coarse - green	15.000
4679-90-931	Reception system	

01

Sanding roller

Very high sanding performance

► **Product description**

- Zirconium corundum, fabric with full resin bond
- Excellent removal capacity
- Size coat with grinding materials
- Areas of use:
- Stainless steel, non-ferrous metals, construction and high-carbon steel as well as difficult-to-machine metal materials
- Sanding of casting skins, removing of welding seams, deburring
- Finishing of shaped surfaces
- Zirconia alumina, fabric with full resin bond



Item no.	Dimensions Ø x width	Graining	Min. rpm	Max. rpm
4675-15-50	15 x 30 mm	50	2.500	36.000
4675-15-150	15 x 30 mm	150	2.500	36.000
4675-22-50	22 x 20 mm	50	18.000	26.000
4675-22-150	22 x 20 mm	150	18.000	26.000
4675-30-50	30 x 30 mm	50	13.000	19.000
4675-30-150	30 x 30 mm	150	13.000	19.000
4675-45-50	45 x 30 mm	50	9.000	13.000

02

Fan roller

► **Product description**

- Precision grinding and polishing
- of stainless steel, steel and non-ferrous metals
- Ideal for deburring and fine polishing
- Achieves even and uniform surface quality



Item no.	Dimensions	Graining	Max. rpm
4675-30-60	30 x 10 x 6 mm	60	18.000
4675-30-80	30 x 10 x 6 mm	80	18.000
4675-30-120	30 x 10 x 6 mm	120	18.000
4675-40-60	40 x 20 x 6 mm	60	18.000
4675-40-80	40 x 20 x 6 mm	80	18.000
4675-60-120	40 x 20 x 6 mm	120	12.000
4675-60-60	60 x 30 x 6 mm	60	12.000
4675-60-80	60 x 30 x 6 mm	80	12.000
4675-80-60	80 x 50 x 6 mm	60	7.500
4675-80-80	80 x 50 x 6 mm	80	7.500

03

Retainer for sanding roller

For use with sanding rollers

► **Product description**

- Rubber body with 6 mm steel shaft
- Non-slip fit of the sanding roller guaranteed by the centrifugal force
- For using of grinding rollers

Item no.	Dimensions
4675-15	15 x 30 mm
4675-22	22 x 30 mm
4675-30	30 x 30 mm
4675-45	45 x 30 mm
4675-60	60 x 30 mm

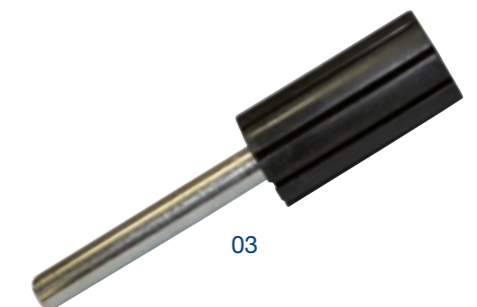

01

Wheel brush

Hardened steel wire, corrugated, diameter 50 mm

Item no.	Model	WIDTH mm	WIRE Ø mm	max. r/min.
4691-926-049	Opel	10 mm	0,3 mm	15.000
4691-926-050	normal	10 mm	0,5 mm	15.000
4691-926-051	narrow	7 mm	0,3 mm	15.000



01

CAUTION
TABLE SPREADS
ACROSS
THE ENTIRE PAGE



02

Centrifugal brush

Steel wire, braided

Item no.	Ø	max. r/min.
4691-925-900	19 mm	20.000
4691-925-901	28 mm	20.000



02

05

Shaft wheel brush

Hardened steel wire, braided, smooth

Item no.	Ø	max. r/min.
4691-925-905	70 mm	20.000



05

03

Twist-knot brush

M14, 65 mm

Item no.	Ø	max. r/min.
4691-925-941	65 mm	12.500



03

06

Long-time brush

Item no.	
4691-925-910	Thickness 7 mm
4691-925-920	Mounting shank Ø 13 mm

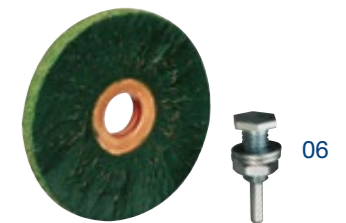

06

04

Universal braided brush

for machines with Ø 125 mm

Item no.	Ø	max. r/min.
4691-925-911	115 mm	12.000



04

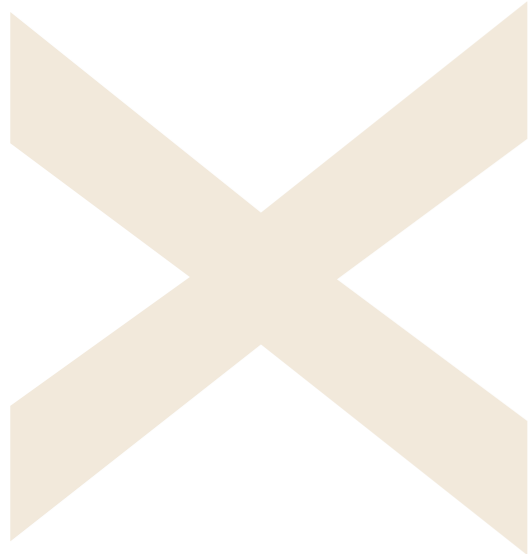

For working on aluminium bodywork.



For removing paint from contours.



For removing films from metal surfaces and paint without damage.

01

Pneumatic machine

ideal for stripe removal discs

► Item no. 4692-123

► Product description

- Weight: 1.1 kg
- Air pressure connection thread: 1/4" PT
- Rotational speed: 0-3,500 rpm
- Required flow pressure: 6.2 bar/90 psi
- Average air consumption: 17.5 CFM (500 l/min)



02

MBX starter kit

For the professional surface preparation

► Item no. 4692-900

► Product description

- Weight: 1.1 kg
- Air pressure connection thread: Rp 1/4"
- Hose diameter required: 3/8 ID (9.5 mm)
- Rotational speed: 0-3,500 rpm
- Required flow pressure: 6.2 bar/90 psi
- Required internal tube diameter: 9,5 mm
- Average air consumption: 17.5 CFM (500 l/min)
- Sound pressure level: 83 dB (DIN 45635-21; ISO 3744)

- Contents:

- 1 x 4692-123 MBX compressed-air machine
- 1 x 4692-211 MBX holder system 1 mm
- 1 x 4692-223 MBX holder system 23 mm
- 1 x 4692-523 MBX brush band, coarse 23 mm
- 1 x 4692-411 MBX brush band, medium 11 mm
- 1 x 4692 311 MBX brush band, fine 11 mm
- 1 x 4692-800 MBX film grinder

01

Brush strip

► Product description

- For example, cleaning steel gaskets



Item no.	Model	Width
4692-311	fine	11 mm
4692-323	fine	23 mm
4692-411	medium	11 mm
4692-423	medium	23 mm
4692-511	coarse with elbow	11 mm
4692-523	coarse with elbow	23 mm

02

Brush strip made of high-grade steel

► Product description

- Ideal for aluminium bodywork



Item no.	Model	Width
4692-611	with elbow	11 mm
4692-623	with elbow	23 mm
4692-723	without elbow	23 mm

03

Stripe removal disc

► Product description

- Easy handling
- High speed
- No damage to paintwork
- High longevity



Item no.	Width
4692-800	23 mm

04

Reception system

► Product description

- The holder is for all brush bands and film grinders 11 mm wide that are used with the MBX processing machine
- The machine adapter is suitable for our patented MBX compressed-air device (art. no. 4692-123)

Item no.	Width
4692-211	11 mm
4692-223	23 mm

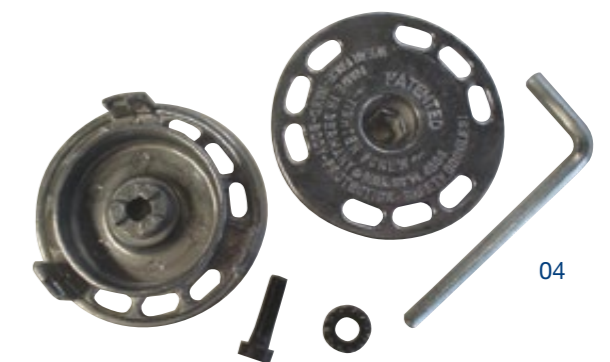

01

Stratus HSS-O spiral drill bits

Profile ground and right-hand cut, DIN 340

► **Product description**

- Special grind:
- Quiet concentric running
- No centre-punching
- Drilling possible on curved surfaces

- **Properties:**

- HSS-O drill bit
- All-round drill bit for almost all materials
- Ground from complete blank
- Greatest breaking strength in all diameters
- Low swarf curvature

- **Point angle:**

- Up to 50% faster than conventional spiral drill bits
- Lower energy demand
- Ideal for cordless drill/driver



01

Item no.	Ø
4627-10	1,0 mm
4627-15	1,5 mm
4627-20	2,0 mm
4627-25	2,5 mm
4627-30	3,0 mm
4627-33	3,3 mm
4627-35	3,5 mm
4627-40	4,0 mm
4627-45	4,5 mm
4627-50	5,0 mm
4627-55	5,5 mm
4627-60	6,0 mm
4627-65	6,5 mm
4627-68	6,8 mm

Item no.	Ø
4627-70	7,0 mm
4627-75	7,5 mm
4627-80	8,0 mm
4627-85	8,5 mm
4627-90	9,0 mm
4627-95	9,5 mm
4627-100	10,0 mm
4627-102	10,2 mm
4627-105	10,5 mm
4627-110	11,0 mm
4627-115	11,5 mm
4627-120	12,0 mm
4627-125	12,5 mm
4627-130	13,0 mm

Item no.	Ø
4627-135	13,5 mm
4627-140	14,0 mm
4627-145	14,5 mm
4627-150	15,0 mm
4627-155	15,5 mm
4627-160	16,0 mm
4627-165	16,5 mm
4627-170	17,0 mm
4627-175	17,5 mm
4627-180	18,0 mm
4627-185	18,5 mm
4627-190	19,0 mm
4627-200	20,0 mm



02

Stratus drill bit box

- Item no. 4627-025-10
- Diameter 2.5 – 10.0 mm (0.5 mm increments)
- Item no. 4627-025-13
- Diameter 2.5 – 13.0 mm (0.5 mm increments)



02

03

Stratus set

- Item no. 1900-98
- Contents: 6-piece kit
- Product description
- Content sizes: 2.0; 3.0; 4.0; 5.0; 6.0; 8.0



03

01

Platinum HSCO spiral drill bits

Profile ground and right-hand cut, DIN 1913

► **Product description**

- Material HSCO (special quality)
- Precision-ground
- Point angle 118°
- Good penetration
- 4-surface grinding
- Aggressive cutting
- High stability and long service life
- Quiet running
- High thermal stability
- Very good swarf removal



01

Item no.	Ø
4628-1-25	2,5 mm
4628-1-30	3,0 mm
4628-1-32	3,2 mm
4628-1-35	3,5 mm
4628-1-40	4,0 mm
4628-1-42	4,2 mm
4628-1-45	4,5 mm
4628-1-50	5,0 mm
4628-1-55	5,5 mm
4628-1-60	6,0 mm
4628-1-65	6,5 mm
4628-1-68	6,8 mm
4628-1-70	7,0 mm

Item no.	Ø
4628-1-75	7,5 mm
4628-1-80	8,0 mm
4628-1-85	8,5 mm
4628-1-90	9,0 mm
4628-1-95	9,5 mm
4628-1-100	10,0 mm
4628-1-105	10,5 mm
4628-1-110	11,0 mm
4628-1-115	11,5 mm
4628-1-120	12,0mm
4628-1-125	12,5 mm
4628-1-130	13,0 mm



02

Platinum drill-bit box

- Item no. 4628-125-010
- Diameter 2.5-10.0 mm (0.5 mm increments)

03

Platinum set

- Item no. 1900-99
- Contents: 6-piece kit
- Product description
- Content sizes: 2.0; 3.0; 4.0; 5.0; 6.0; 8.0



02



03

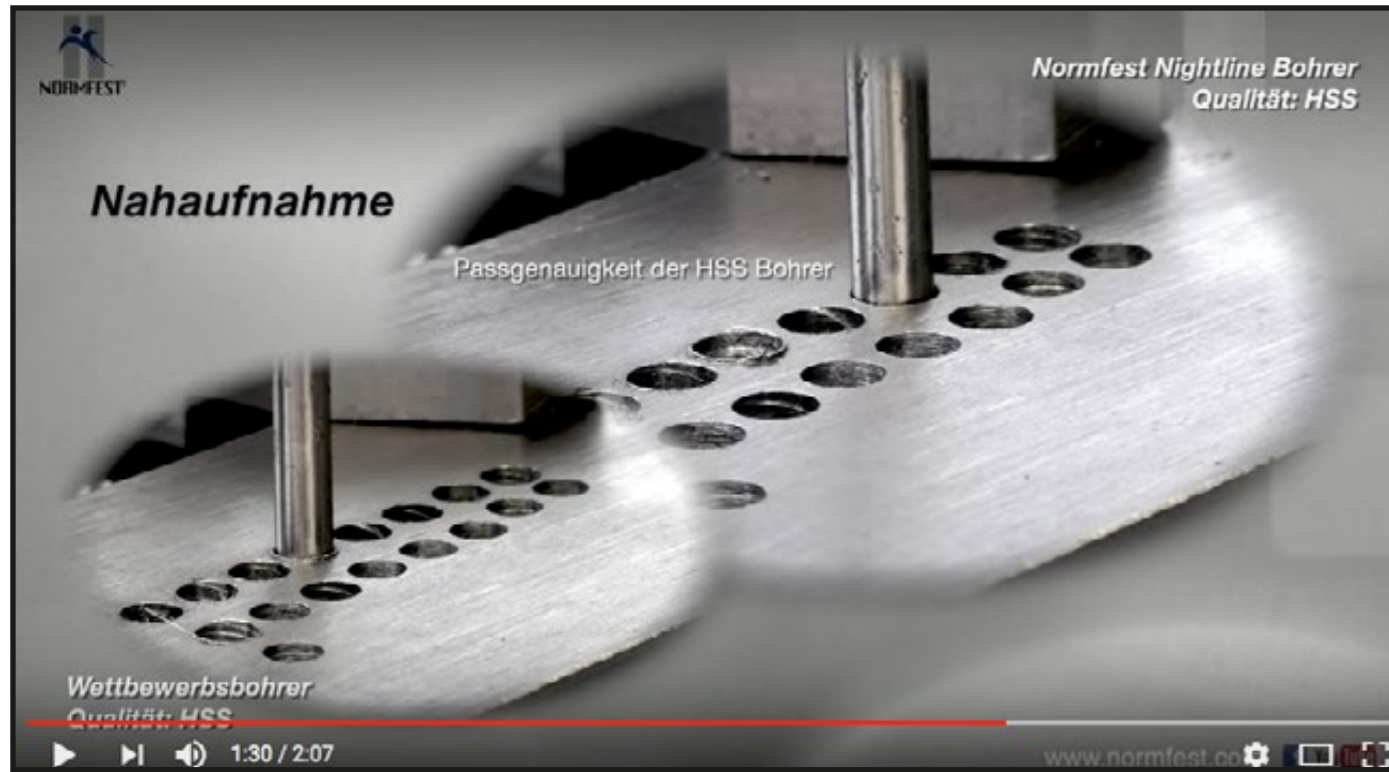

01
Night Line HSS spiral bits
Profile ground, DIN 338

- ▶ **Product description**
- Profile-ground
- Ground out from a complete blank
- HSS drill bit
- Suitable for manual drills
- Point angle 118°
- Relatively good penetration
- Reduced cross-cutting
- High stability
- Quiet running



01

Item no.	Ø
4626-10	1,0 mm
4626-100	10,0 mm
4626-105	10,5 mm
4626-110	11,0 mm
4626-115	11,5 mm
4626-120	12,0 mm
4626-125	12,5 mm
4626-130	13,0 mm
4626-135	13,5 mm
4626-140	14,0 mm
4626-15	1,5 mm

Item no.	Ø
4626-20	2,0 mm
4626-25	2,5 mm
4626-30	3,0 mm
4626-35	3,5 mm
4626-40	4,0 mm
4626-42	4,2 mm
4626-45	4,5 mm
4626-48	4,8 mm
4626-50	5,0 mm
4626-52	5,2 mm
4626-55	5,5 mm

Item no.	Ø
4626-60	6,0 mm
4626-62	6,2 mm
4626-65	6,5 mm
4626-68	6,8 mm
4626-70	7,0 mm
4626-75	7,5 mm
4626-80	8,0 mm
4626-85	8,5 mm
4626-90	9,0 mm
4626-95	9,5 mm

02
Night Line drill-bit box

- ▶ Item no. 4626-001-10
- ▶ Diameter 1.0-10.0 mm (0.5 mm increments)
- ▶ Item no. 4626-001-13
- ▶ Diameter 1.0-13.0 mm (0.5 mm increments)



02

03
Night Line set

- ▶ Item no. 1900-97
- ▶ Contents: 13-piece kit
- ▶ **Product description**
- Content sizes: 2.0; 2.5; 3.0; 3.5; 4.0; 4.5; 5.0; 5.5; 6.0; 6.5; 7.0; 7.5; 8.0



03

04
Drilling and Cutting Aid
Easy-Cut

- ▶ Item no. 2894-443
- ▶ Contents: 350 ml
- ▶ Packing unit: 12

- ▶ **Product description**
- Supports swarf removal
- Reduces friction between drill bit and workpiece
- Drill bit and workpiece are lubricated and cooled
- Clear extension of service life
- Corrosion protection for the drill hole



04

01
Stratus HSS-O twist drill bit assortment
 Profile ground and right-hand cut, DIN 384

▶ Item no. 1957-627-1

Contents: 120 parts

- 5 x 1.0 mm (art. no. 4627-10)
- 5 x 1.5 mm (art. no. 4627-15)
- 5 x 2.0 mm (art. no. 4627-20)
- 5 x 2.5 mm (art. no. 4627-25)
- 3 x 3.0 mm (art. no. 4627-30)
- 3 x 3.5 mm (art. no. 4627-35)
- 3 x 4.0 mm (art. no. 4627-40)
- 3 x 4.5 mm (art. no. 4627-45)
- 3 x 5.0 mm (art. no. 4627-50)
- 3 x 5.5 mm (art. no. 4627-55)
- 3 x 6.0 mm (art. no. 4627-60)
- 3 x 6.5 mm (art. no. 4627-65)
- 3 x 7.0 mm (art. no. 4627-70)
- 3 x 7.5 mm (art. no. 4627-75)
- 3 x 8.0 mm (art. no. 4627-80)
- 3 x 8.5 mm (art. no. 4627-85)
- 3 x 9.0 mm (art. no. 4627-90)
- 3 x 9.5 mm (art. no. 4627-95)
- 3 x 10.0 mm (art. no. 4627-100)
- 3 x 10.5 mm (art. no. 4627-105)

02
Night Line HSS twist drill bit assortment
 Basic assortment

▶ Item no. 1957-626

Contents: 120 Teile

- 5 x 10.5mm (art. no. 4626-105)
- 5 x 10.0mm (art. no. 4626-100)
- 5 x 9.5mm (art. no. 4626-95)
- 5 x 9.0mm (art. no. 4626-90)
- 5 x 8.5mm (art. no. 4626-85)
- 5 x 8.0mm (art. no. 4626-80)
- 5 x 7.5mm (art. no. 4626-75)
- 5 x 7.0mm (art. no. 4626-70)
- 5 x 6.5mm (art. no. 4626-65)
- 5 x 6.0mm (art. no. 4626-60)
- 5 x 5.5mm (art. no. 4626-55)
- 5 x 5.0mm (art. no. 4626-50)
- 5 x 4.5mm (art. no. 4626-45)
- 5 x 4.0mm (art. no. 4626-40)
- 5 x 3.5mm (art. no. 4626-35)
- 5 x 3.0mm (art. no. 4626-30)
- 10 x 2.5mm (art. no. 4626-25)
- 10 x 2.0mm (art. no. 4626-20)
- 10 x 1.5mm (art. no. 4626-15)
- 10 x 1.0mm (art. no. 4626-10)



01



02

03
Solid carbide milling machine
 For spot weld remover, for high strength sheet metal

▶ Item no. 4710-008-044
 ▶ 8 x 44 mm

▶ Item no. 4710-008-046
 ▶ 8 x 46 mm



03

04
Welding spot milling machine
 HSS for drill

▶ Item no. 4698-1

Spare core cutter for art. No.: 4698-1

▶ Item no. 4698-01



04

05
Welding spot milling machine
 HSCO, cutter diameter: 8.0mm, length: 46mm, PU: 10

▶ Item no. 4710-112-900



05

06
Welding spot drill
 HSCo-TICN for drill, for high-strength sheet metal

▶ Item no. 4710-006
 ▶ 6 x 70 mm ▶ 10 x 90 mm

▶ Item no. 4710-008
 ▶ 8 x 80 mm

▶ Item no. 4710-010



06

07
Welding spot drill
 HSS for drill

▶ Item no. 4710-6
 ▶ Drill bit Ø: 6.0 mm

▶ Item no. 4710-8
 ▶ Drill bit Ø: 8.0 mm

▶ Item no. 4710-10
 ▶ Drill bit Ø: 10.0 mm



07

08
Spot-weld drill bit
 Application temperature is max. 800°C

▶ Item no. 4710-206
 ▶ 8 x 80 mm

▶ Item no. 4710-208
 ▶ 10 x 90 mm

▶ Item no. 4710-210
 ▶ 6 x 70 mm



08

01

Spot weld remover

▶ Item no. 8696-112-915

▶ Technical specifications

- No-load speed: 600 rpm
- Weight: 2.2 kg
- Air pressure: 6.3 bar
- Compressed air fitting: 1/4"
-
- Low heat build-up
- Low influence on surface tension = less warping of the surface being processed
- Precise cutting
- Longer drill service life, resulting in greater cost effectiveness
- Minimisation of the risk of breaking drill tips and lands
- Especially suitable for use on super-high-strength sheet metal
-
- Patented pneumatic drill spindle feed for constant contact pressure
- Detachable stop for internal and external spot welds
-
- PLEASE NOTE: This article is excluded from the loyalty promotion!



02

Conical drill bits

HSS

▶ Product description

- Point grinding: Factory standard
- Reduction of cutting edge: DIN 1412 C
- Sharpening angle: 118°
- Taper angle: 20-30°
- Ø tolerance: Factory standard
- Shaft: Triple clamping surface
- Surface: Polished
- Right-hand cutting
- Shaft Ø: 6 mm

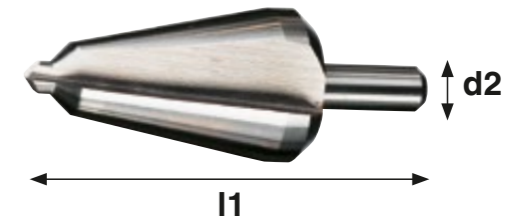

Item no.	Model	d2	L1
4694-015-41	Size 1: 3 – 14.0 mm	6 mm	58 mm
4694-015-42	Size 2: 5 – 20.0 mm	8 mm	71 mm
4694-015-43	Size 3: 16 – 30.5 mm	9 mm	76 mm
4694-015-44	Size 4, 24 - 40.0 mm	10 mm	89 mm
4694-015-46	Size 5, 36 - 50.0 mm	12 mm	97 mm

03

Unidrill conical drill bits

HSS, crosswise grinding

▶ Item no. 4691-921-495

▶ 5-31 mm, d2 = 9 mm, l1= 103 mm

▶ Product description

- Point grinding: Works standard
- Point thinning: DIN 1412 C
- Point angle: 118°
- Angle of taper: 20-30°
- Diameter tolerance: Works standard
- Shank: Triple clamping surface
- Surface: uncoated
- Right-hand cut



01

Unibit stepped drill bit

HSS 4-30mm

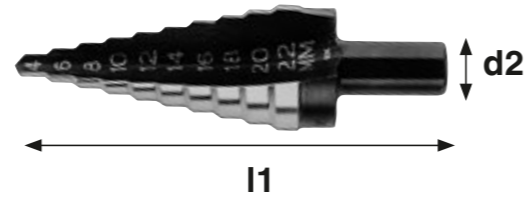

Item no.	Model	Grading	d2	L1
4691-921-304	4 - 30 mm	5 mm	13.0 mm	78,0 mm

02

Conical drill bit set

HSS

► Product description

- Point grinding: Works standard
- Point thinning: DIN 1412 C
- Point angle: 118°
- Angle of taper: 20-30°
- Diameter tolerance: Works standard
- Shank: Triple clamping surface
- Surface: uncoated
- Right-hand cut



Item no.	Model	d2	L1
4694-015-41	Size 1: 3 – 14.0 mm	6 mm	58 mm
4694-015-42	Size 2: 5 – 20.0 mm	8 mm	71 mm
4694-015-43	Size 3: 16 – 30.5 mm	9 mm	76 mm

03

Carbide end mill

Cylindrical with front end cut

► Product description

- 12,000 and 14,000 rpm
- Tool life up to four times that of uncoated tools
- Model: Shape A cylindrical with front end cut
- Tooth system: Cross tothing
- Cutting: KVZ 4/aluminium
- Surface: TiCN coating

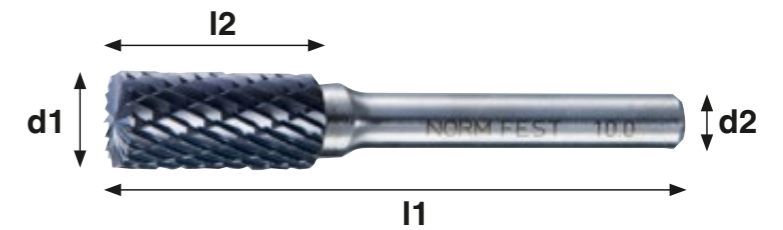

Item no.	d1 mm	d2 mm	L1 mm	L2 mm
4681-161-019	10	6	60	20

04

Carbide burrs

Arc pointed nose

► Product description

- 12,000 and 14,000 rpm
- Tool life up to four times that of uncoated tools
- Model: Shape G arc pointed nose (tree)
- Tooth system: Cross tothing
- Cutting: KVZ 4/aluminium
- Surface: TiCN coating

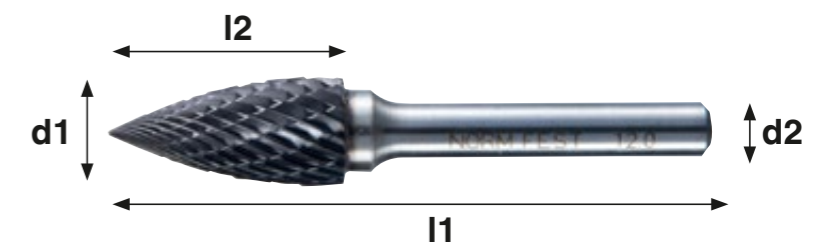

Item no.	d1 mm	d2 mm	L1 mm	L2 mm
4681-661-325	12	6	65	25

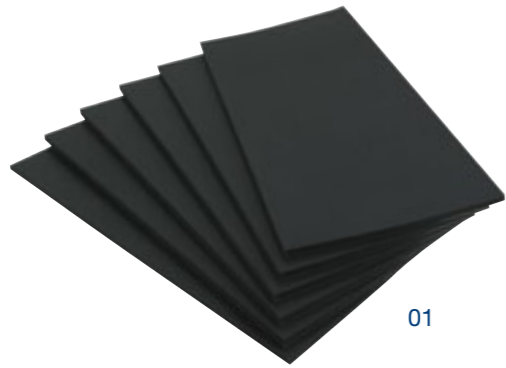

01

01
Silence Foam
Foam acoustic boards

▶ Item no. 4580-774

▶ Product description

- Thermally stable from -25°C to +90°C
- Abrasion-resistant surface
- Dimensions: 550 x 250 x 10 mm
- Colour: anthracite
- PU: 6

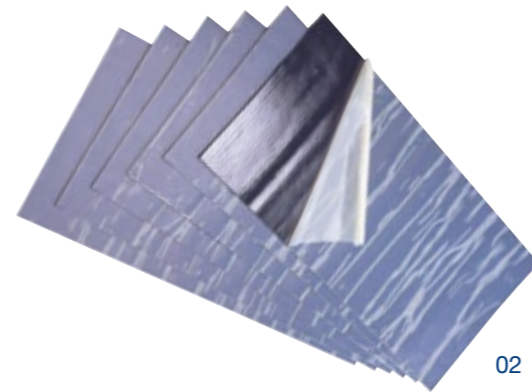

02

02
Sound-absorbing plate
Bitumen acoustic boards

▶ Item no. 4580-773

▶ Product description

- Thermally stable to +90°C
- Colour: Black
- Dimensions: 550 x 250 x 2 mm
- PU: 6



05

05
Trim strip tape
Rolls each 10 m

▶ Item no. 4991-06
▶ 6 mm

▶ Item no. 4991-12
▶ 12 mm

▶ Item no. 4991-19
▶ 19 mm

▶ Item no. 4991-24
▶ 24 mm

▶ Product description
- Colour: black
- Double-sided adhesion
- High final strength

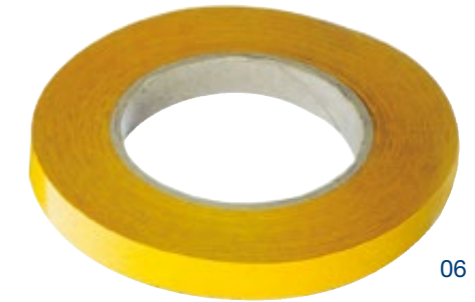

06

06
Adhesive tape for protective film
Rolls each 50 m

▶ Item no. 4991-50-19
▶ 19 mm

▶ Item no. 4991-50-38
▶ 38 mm

▶ Product description
- Colour: transparent
- Double-sided adhesion



03

03
Duroplastic sealing tape
Sealtape

▶ Item no. 4581-770

▶ Product description

- Flat
- Roll length: 26 m
- Solvent-free
- Temperature-resistant, non-ageing and weatherproof
- Temperature range -30°C to +100°C
- Eliminates annoying bodywork noises
- Dimensions: 20 x 2 mm



04

04
Duroplastic sealing tape, black
Butylband Plus

▶ Item no. 4581-777

▶ Product description

- Eliminates annoying bodywork noises
- Cord diameter: 8 mm
- Length: 10 m

07
Self-adhesive protective film tinted
0.6 x 100 m, thickness 90µ

▶ Item no. 7991-100

▶ Product description
- Can also be used as door lining film



07



01



02



03



06



07



08

01 Super-fast superglue
Cyanacrylate adhesives black

- ▶ Item no. 2898-555
- ▶ Contents: 5 g
- ▶ Packing unit: 1

- ▶ Item no. 2898-556
- ▶ Contents: 20 g
- ▶ Packing unit: 1

- ▶ **Product description**
- Suitable for smooth plastic surfaces
- Pinpoint application accuracy

02 Black cyanacrylate adhesive Superfast

- ▶ Item no. 2898-560-20
- ▶ Contents: 20 g
- ▶ Packing unit: 1

- ▶ **Product description**
- Suitable for bonding rubber coatings, plastics and metals

- Ideal for bonding plastics, such as door clips
- Based on cyanacrylate

03 Superglue filler
For cyanoacrylate adhesives

- ▶ Item no. 2898-560-30
- ▶ Contents: 30 g
- ▶ Packing unit: 1

- ▶ **Product description**
- Density: > 1.5g/cm³ 20°C

06 Superglue gel Fixit

- ▶ Item no. 2898-554
- ▶ Contents: 20 g
- ▶ Packing unit: 1

- ▶ **Product description**
- Does not run
- Can be used on horizontal and vertical surfaces
- Does not form strings
- For bonding metals, wood and plastics
- Based on cyanacrylate

07 Accelerator Fixit Active

- ▶ Item no. 2898-554-150
- ▶ Contents: 200 ml
- ▶ Packing unit: 1

- ▶ **Product description**
- Suitable as a curing accelerator for all cyanacrylate adhesives
- For leather, wood, cork, ceramics and all porous materials and for bonding plastics

08 Power spray adhesive Super-Glue

- ▶ Item no. 2898-552
- ▶ Contents: 400 ml
- ▶ Packing unit: 12

- ▶ **Product description**
- Foamed materials, jute, felt, expanded polystyrene
- Paper, cardboard, plastic films
- Various plastics
- Temperature range (permanent): -25°C to +70°C

04 Extreme cyanoacrylate superglue Rapido

- ▶ Item no. 2898-555-100
- ▶ Contents: 20 g
- ▶ Packing unit: 12

- ▶ **Product description**
- For extreme loads and flexible adhesions
- Basis: cyanoacrylate



04



05

05 Rubber profile adhesive Profix

- ▶ Item no. 2898-551
- ▶ Contents: 180 g
- ▶ Packing unit: 12

- ▶ **Product description**
- Ideal for gluing: Rubber profile, leather, plastic, imitation leather with textile backing and felt to metal, wood, rigid PVC, ABS, PA

09 Two-component cyanoacrylate adhesive 2-c CA

- ▶ Item no. 2700-25
- ▶ Contents: 10 g
- ▶ Packing unit: 1

- ▶ **Product description**
- Rapid hardening
- For up to 6 mm gaps
- Gel consistency (for work on vertical surfaces)
- No drips
- Accurate and clean application using the mixer nozzle
- Perfect for all quick repairs to damaged components and for emergency repairs
- Outstanding adhesive properties for almost every current material
- Handling time: 90 - 150 seconds, depending on the

NEU

10 Mix nozzles, 10 pieces

- ▶ Item no. 2700-25-1



09

01
Butane gas

- ▶ Item no. 8714-607-100
- ▶ Contents: 100 ml
- ▶ Packing unit: 12

- ▶ Product description
- Suitable for all common hot-melt and soldering guns

02
Tinning paste
Lead-free

- ▶ Item no. 4982-91
- ▶ Contents: 1 kg
- ▶ Packing unit: 1

- ▶ Product description
- Applied before the actual tin plating, to provide an ideal key for the bodywork on the metal
- Cleans and degreases

03
Soldering tin
Bar, pressed

- ▶ Item no. 4982-1

- ▶ Product description
- PB (lead): 74%
- SN (tin): 25%
- SB (antimon): 1%
- Standard designation: DIN EN 29453

- Packaging unit: 5 kg (5 x 1kg rods)

04
Tinsol - Filling Solder Substitute

Tinsol is the new repair method for metal bodywork.

- ▶ Item no. 2893-224-1
- ▶ Contents: 250 ml
- ▶ Packing unit: 1

- ▶ Product description
- Pot life of 50 minutes at 23°C
- Moisture-resistant and weatherproof
- Temperature range -30°C to +120°C
- (temporarily up to +180°C)
- No expensive replacement parts

05
Oxy-fuel gas
Extra hot

- ▶ Item no. 8714-608-600
- ▶ Contents: 600 ml
- ▶ Packing unit: 24

- ▶ Product description
- Max. temperature 2,000°C
- Mixture of propane, butane, acetone and isobutane
- Suitable for tin-plating and brazing
- Extra hot

06
Piezo burner nozzle ECO

- ▶ Item no. 8714-609-1
- ▶ Product description
- Soldering with tin-solder for aluminium
- Bending of rods, sheet metal and pipes
- Heating of objects
- Suitable for fuel gas (8714-608-600)

07
Square spatula
▶ Item no. 2893-223-38





01

High temperature protective blanket

Suitable for welding and bodywork repairs

► Item no. 4982-001

► Product description

- Resistant to sparks and spatter
- Material: Glass filament fabric (flame-resistant, non-combustible)
- Weight: 3.5 kg
- Dimensions: 160 x 230 cm with fastening straps
- Thickness: 0.5 mm
- Heat resistant: up 750°C
- Elongation at break: 3%

02

Protective welding blanket

Designed to catch and hold spark and spatter

► Item no. 4982-000

► Product description

- Dimensions: 229 x 188.5 cm
- Heat resistant: up 700°C
- Max. radiation temperature: up to 1,000°C
- Abrasion and knick-proof

03

Protective welding gloves

A combination of leather and split leather

► Item no. 7797-012-10
► Size 10

► Product description

- 5-finger welding gloves
- Cowhide/Split leather
- Split cuff
- Length: 35 cm
- TÜV Rhineland tested
-
- Performance values
- EN 388 and EN 12477
- Cat. 2
- Performance values 3123 + 412X4X

04

Folding welder goggles

► Product description

- These goggles complete with flip-up front provide a clear view when welding.

Item no.	Model
4695-006-460	Goggles
4695-006-461	Spare lenses non shattering
4695-006-465	Spare lenses athermal



01



02



03



04



01
PRO automatic helmet
Carbon look

► Item no. 4695-007-100

► Product description

- Anti-glare dark slide: 1/1/1/2
- Scale numbers DIN 4/5-8 and 9-13
- WIG-suitable from 5 amperes
- Grinding mode
- Large viewing field 53 x 100mm
- Four mutually independent sensors
- Smoothly adjustable
- Power supply using solar cell & replaceable support battery
- Standard attached pane 90 x 110mm
- Interchangeable replacement attached pane. art.no. 4695-007-110



01

02
Viewing pane 90 x 110 mm
for (4695-007-100)

► Item no. 4695-007-110



02

03
Hand shield

► Product description

- Partly heat-resistant hand shield without attached pane
- The clear and green attached panes are interchangeable

Item no.	Model
4695-006-440	Shield (without glass)
4695-006-442	Cover lenses clear
4695-006-446	Green lens



03

04
Gas pressure reducer
for inert gas welders

► Item no. 4983-108



04

05
adapter
for basket coils

► Item no. 4982-008-100

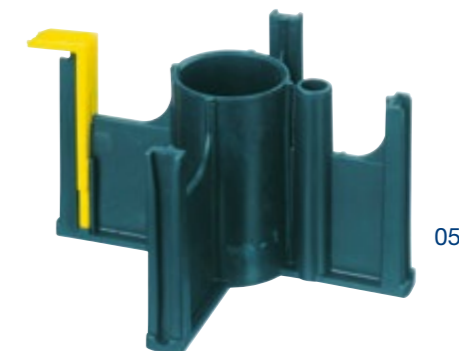

05

01

Inert gas welding wire

SG 2 for steel, each spool 15 kg

- ▶ Item no. 4982-008
- ▶ 0.8 mm

- ▶ Item no. 4982-010
- ▶ 1.0 mm

- ▶ Item no. 4982-012
- ▶ 1.2 mm



01

02

Inert gas welding wire

SG1 A for galvanised sheet steel, each spool 15 kg

- ▶ Item no. 4982-018



02

03

Autogenous filler wire

Rod, G1

- ▶ Item no. 4982-002
- ▶ 2.0 mm x 1,000 mm

- ▶ Item no. 4982-003
- ▶ 3.0 mm x 1,000 mm



03

04

Corrugated wire

For 6" claw

- ▶ Item no. 8714-821-079
- ▶ Length: 360 mm
- ▶ Ø 2 mm



04

05

Oerlikon welding electrodes

Overcord

- ▶ Item no. 4982-044-152
- ▶ 2.5 x 350 mm

- ▶ Item no. 4982-044-158
- ▶ 3.2 x 350 mm

- ▶ Product description
- Medium thick coated rutile cellulosic electrode
- Particularly suitable for vertical down welding
-
- Properties:
- Yield strength ReH N/qmm > 380
- Tensile strength Rm N/qmm 470-600
- Elongation at break A5 % > 20
- Notch bar impact value (ISO-V) 20°C J 80
-
- Approvals:
- TÜV Pfalz



05

06

Oerlikon welding electrodes

Fincord, rutile type

- ▶ Item no. 4982-044-147
- ▶ 2.5 x 350 mm

- ▶ Item no. 4982-044-154
- ▶ 3.2 x 350 mm

- ▶ Product description
- Thickly coated rutile cellulosic electrode
- Minimum spatter formation
- Can be used for all positions, except vertical down welding
-
- Properties:
- Yield strength ReH N/qmm > 420
- Tensile strength Rm N/qmm 500-640
- Elongation at break A5 % > 20
-
- Approvals:
- TÜV Pfalz



06

07

Welding nails

- ▶ Item no. 8714-821-077
- ▶ Ø 2.0 mm

- ▶ Item no. 8714-821-078
- ▶ Ø 2.6 mm



07

08

Washers untreated

- ▶ Item no. 6405-8
- ▶ Ø 8 mm

- ▶ Item no. 6405-10
- ▶ Ø 10 mm



08

01

Torch pipe 250 A

flexible, screwed, MIG/MAG

Item no.	model	illustration
4983-252-1	Gas nozzle, conical, screwed	1
4983-110-1	Nozzle fitting M6	2
4983-255-008	Current nozzle 0.8 mm, nickel-faced	3
4983-255-010	Current nozzle 1.0 mm, nickel-faced	4



04

Torch pipe 250 A

flexible, plugged, MIG/MAG

Item no.	model	illustration
4983-252	Gas nozzle, conical, connected	1
4983-251-2	Burner pipe, flexible, plugged	2
4983-110-1	Nozzle fitting M6	3
4983-255-008	Current nozzle 0.8 mm, nickel-faced	5
4983-255-010	Current nozzle 1.0 mm, nickel-faced	6

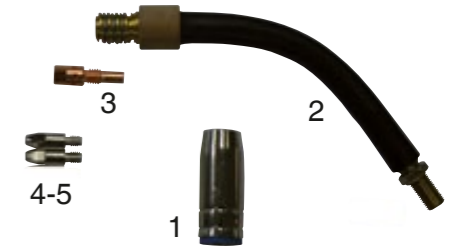

02

Torch pipe 250 A

inflexible, connected, MIG/MAG

Item no.	model	illustration
4983-252	Gas nozzle, conical, connected	1
4983-110-1	Nozzle fitting M6	2
4983-255-008	Current nozzle 0.8 mm, nickel-faced	3
4983-255-010	Current nozzle 1.0 mm, nickel-faced	4



05

Welding torch hose package

For standard MIG/MAG welding torches

► Item no. 4983-250

► Product description

- Cooling: air cooling
- Wire diameter: 0.8 to 1.2 mm
- Gas flowrate: 10 l/min
- Neck: rigid
- System for inserted gas nozzles
- Cable: flexible-rubber coaxial cable
- Technical specification: in accordance with IEC 60974-7
- Weight with 5 m cable: 3.6 kg
- Connection: Standard European plug
- Power rating at 60% on-time
- (10 minute cycle)
- for mixed gas 200 A
- for CO2 230 A



03

Torch pipe 250 A

rigid, screwed, MIG/MAG

Item no.	model	illustration
4983-252-1	Gas nozzle, conical, screwed	1
4983-110-1	Nozzle fitting M6	2
4983-255-008	Current nozzle 0.8 mm, nickel-faced	3
4983-255-010	Current nozzle 1.0 mm, nickel-faced	4



06

Blast connection 250 A

For inserted gas nozzles

► Item no. 4983-110-1



06

07

Gas nozzle spring inserted

For inserted torch systems 250 A

► Item no. 4983-253



07

01

Burner pipe 150 A

flexible, plugged, MIG/MAG

Item no.	model	illustration
4983-102	Gas nozzle, conical, pluggable	1
4983-103	Spot welding nozzle, can be inserted	2
4983-113	Burner pipe, flexible, plugged	3
4983-105-008	Current nozzle 0.8 mm, nickel-faced	4
4983-105-010	Current nozzle 1.0 mm, nickel-faced	5

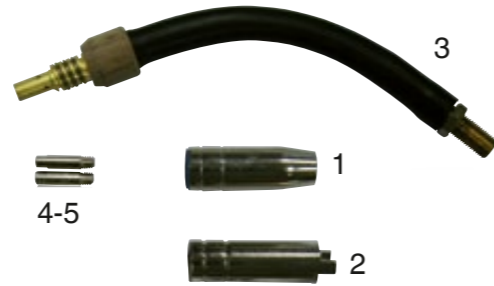

02

Burner pipe 150 A

flexible, screwed, MIG/MAG

Item no.	model	illustration
4983-102-1	Gas nozzle, conical, screwed	1
***???	ATTB Standard:1	2
4983-105-008	Current nozzle 0.8 mm, nickel-faced	3
4983-105-010	Current nozzle 1.0 mm, nickel-faced	4



03

Blast connection 150 A

► Item no. 4983-110

► M6

► Product description

- Suitable for: 4983-101, 4983-101-5, 4983-112



04

Torch pipe package 150A

For standard MIG/MAG welding torches

► Item no. 4983-101

► Length: 3 m

► Item no. 4983-101-5

► Length: 5 m

► Product description

- The 5 m cable makes it particularly suitable for vans

- Power rating 150 A for mixed gas or 180 A for CO2

- Contact nozzle 1.2 mm



05

Gas jet

pluggable

► Item no. 4983-102



06

Burner pipe 150 A

rigid, pluggable

► Item no. 4983-112



07

Spot welding nozzle 150 A

pluggable

► Item no. 4983-103



08

Gas nozzle spring inserted

For inserted torch systems 150 A

► Item no. 4983-109



CAUTION
TABLES SPREAD
ACROSS THE
ENTIRE PAGE

01

Blind rivet with flat round head

DIN 7337, rivet body: galvanised steel / rivet mandrel: galvanised steel



Item no.	Rivet sleeves Ø d1 mm	Sleeves L mm	Bore Ø mm	Rivetable material thickness	Head Ø d2 mm	Height of head mm
5938-48-8	4,8	8,0	4,9	2,5 - 4,5	9,5	1,1
5938-48-12	4,8	12,0	4,9	6,0 - 8,0	9,5	1,1
5938-48-14	4,8	14,0	4,9	8,0 - 10,0	9,5	1,1
5938-48-16	4,8	16,0	4,9	10,0 - 11,5	9,5	1,1
5938-64-12	6,4	12,0	6,5	3,0 - 6,0	13,0	1,8
5938-64-15	6,4	15	6,5	6,0 - 9,0	13,0	1,8
5938-64-18	6,4	18	6,5	9,0 - 12,0	13,0	1,8
5938-64-22	6,4	22	6,5	12,0 - 16,0	13,0	1,8

02

Blind rivet with flat round head

Aluminium, for soft or fragile material

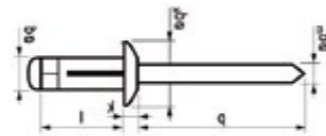

Item no.	Rivet sleeves Ø d mm	Sleeves L mm	Bore hole Ø mm	Clamping range	d mm	dk ??? mm	k mm	dm mm	Tensile- force (N)	Shearing force (N)
5937-040-188	4	18,8	4,2 - 4,4	3,0 - 7,0	≥ 27	8,0	≤ 1,7	~ 2,5	800	500

03

Blind rivet with truss-head

Rivet body: aluminium, Rivet mandrel: aluminium



Item no.	Rivet sleeves Ø d1 mm	Sleeves L mm	Bore Ø mm	Rivetable material thickness	Head Ø d2 mm
5937-048-205	4,8	20,5	4,3	3,0 - 9,0	8,0

01

**Blind rivet
with flat round head**

Rivet body: aluminium alloy, rivet mandrel: Galvanised steel

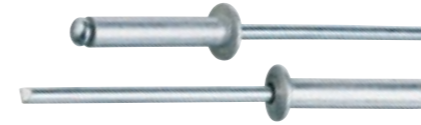
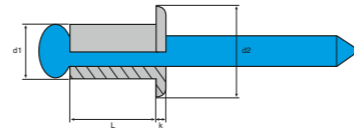

**CAUTION
TABLES SPREAD
ACROSS THE
ENTIRE PAGE**

Item no.	Rivet sleeves Ø d1 mm	Sleeves L mm	Bore Ø mm	Rivetable material thickness	Head Ø d2 mm	Height of head k/mm
5937-24-6	2,4	6,0	2,5	2,0 - 4,0	5,0	0,6
5937-24-8	2,4	8,0	2,5	4,0 - 6,0	5,0	0,6
5937-3-6	3	6,0	3,1	1,5 - 3,5	6,5	0,8
5937-3-8	3	8	3,1	3,5 - 5,5	6,5	0,8
5937-3-10	3	10	3,1	5,5 - 7,0	6,5	0,8
5937-3-16	3	16	3,1	9,0 - 13,0	6,5	0,8
5937-32-10	3,2	10	3,3	5,5 - 7,0	6,5	0,8
5937-4-6	4	6	4,1	0,5 - 3,0	8,0	1,0
5937-4-8	4	8	4,1	3,0 - 5,0	8,0	1,0
5937-4-10	4	10	4,1	5,0 - 6,5	8,0	1,0
5937-4-12	4	12	4,1	6,5 - 8,5	8,0	1,0
5937-4-16	4	16	4,1	8,5 - 12,5	8,0	1,0
5937-48-8	4,8	8	4,9	3,0 - 4,5	9,0	1,1
5937-48-10	4,8	10	4,9	4,5 - 6,0	9,0	1,1
5937-48-16	4,8	16	4,9	6,0 - 12,0	9,0	1,1
5937-5-8	5,0	8	5,1	3,0 - 4,5	9,0	1,1
5937-5-10	5,0	10	5,1	4,5 - 6,0	9,0	1,1
5937-5-12	5,0	12	5,1	6,0 - 8,0	9,0	1,1
5937-5-16	5,0	16	5,1	8,0 - 12,0	9,0	1,1
5937-5-20	5,0	20	5,1	12,0 - 16,0	9,0	1,1
5937-5-25	5,0	25	5,1	16,0 - 21,0	9,0	1,1
5937-5-40	5,0	40	5,1	30,0 - 35,0	9,0	1,1
5937-6-8	6,0	8	6,1	3,0 - 4,5	12,0	1,5
5937-6-10	6,0	10	6,1	4,5 - 6,0	12,0	1,5
5937-6-12	6,0	12	6,1	6,0 - 8,0	12,0	1,5
5937-6-16	6,0	16	6,1	8,0 - 12,0	12,0	1,5

02

Sealing blind rivet

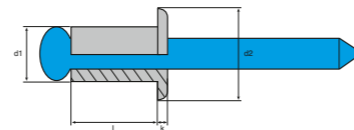
air- and waterproof



Item no.	Rivet sleeves Ø d1 mm	Sleeves L mm	Bore Ø mm	Rivetable material thickness	Head Ø d2 mm
5937-048-12	4,8	12,5	4,9	6,5 - 8	9,5

**CAUTION
TABLES SPREAD
ACROSS THE
ENTIRE PAGE**

01

Blind rivet with large snap-head

Rivet body: aluminium, rivet mandrel: galvanised steel

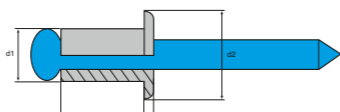

Item no.	Rivet sleeves Ø d1 mm	Sleeves L mm	Bore Ø mm	Rivetable material thickness	Head Ø d2 mm	Height of head k/mm
5944-4-85	4	8,5	4,1	4,5 - 6,0	12,0	1,4
5944-11-8	5	8,0	5,1	0,5 - 4,5	11,0	1,5
5944-11-10	5	10,0	5,1	4,5 - 6,0	11,0	1,5
5944-11-12	5	12,0	5,1	6,0 - 8,0	11,0	1,5
5944-11-16	5	16,0	5,1	8,0 - 12,0	11,0	1,5
5944-11-20	5	20	5,1	12,0 - 16,0	11,0	1,5
5944-11-25	5	25	5,1	16,0 - 21,0	11,0	1,5
5944-11-30	5	30	5,1	21,0 - 25,0	11,0	1,5
5944-14-8	5	8	5,1	0,5 - 4,5	14,0	1,5
5944-14-10	5	10	5,1	4,5 - 6,0	14,0	1,5
5944-14-12	5	12	5,1	6,0 - 8,0	14,0	1,5
5944-14-16	5	16	5,1	8,0 - 12,0	14,0	1,5
5944-14-20	5	20	5,1	12,0 - 16,0	14,0	1,5

02

Blind rivet, black

with truss-head/ according to DIN 7337

rivet sleeve: aluminium, black painted

rivet spike: steel, galvanised

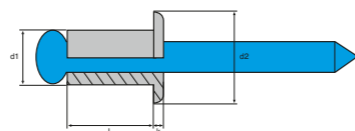

Item no.	Rivet sleeves Ø d1 mm	Sleeves L mm	Bore Ø mm	Rivetable material thickness	Head Ø d2 mm
5937-32-751	3,2	7,5	3,3	3,0 - 5,0	9,5
5937-4-81	4,0 (VW)	8,0	4,1	3,0 - 5,0	12,0
5937-4-141	4,0 (VW)	14,0	4,1	7,5 - 11,0	12,0
5937-48-141	4,8	14,0	4,9	7,5 - 11,0	12,0

03

Expansion blind rivet

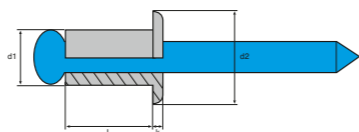

Item no.	Rivet sleeves Ø d1 mm	Sleeves L mm	Bore Ø mm	Rivetable material thickness	Head Ø d2 mm
5937-004-821	4,8	21	4,9	8,0 - 15,0	9,5

01

Blind rivet nuts with flat head



Item no.	Rated measurement	Bore Ø mm	Rivetable material thickness	Shank length L mm	Outer Ø d1 mm	Head Ø d2 mm	K mm
5949-4-115	M4 x 6 x 11,5	6,0	0,5 - 3,0	11,0	6	9,0	1,1
5949-5-12	M5 x 7 x 12,0	7,0	0,5 - 3,0	14,0	7	10,0	1,1
5949-6-145	M6 x 9 x 14,5	9,0	0,5 - 3,0	16,0	9	12,0	1,6
5949-8-16	M8 x 11 x 16,0	11,0	0,5 - 3,0	17,5	11	15,0	1,6
5949-8-185	M8 x 11 x 18,5	11,0	3,0 - 5,5	20,0	11	15,0	1,6
5949-10-17	M10 x 12 x 17,0	12	0,5 - 3,0	19,0	12	16,0	2,1
5949-10-22	M10 x 12 x 22,0	12	3,0 - 6,0	24,0	12	16,0	2,1
5949-12-23	M12 x 16 x 23,0	16	1,0 - 4,0	25,0	16	22,0	2,1

02

Blind rivet nuts with flat head

6-edge, heavily galvanised



Item no.	Thread diameter	l mm	Punched hole Ø mm	Clamping range mm	Ødk ??? mm	Height of head k/mm	SW	Tensile strength [N]	Shear force [N]
5950-4-97	M4	10,5	6	0,3 - 2,0	9	≤ 0,8	5,9	6.800	2.200
5950-5-13	M5	13,0	7	0,7 - 3,0	10	≤ 1,0	6,9	10.000	3.300
5950-6-145	M6	16,0	9	0,5 - 3,0	13	≤ 1,5	8,9	15.000	4.400
5950-8-155	M8	17,0	11	0,5 - 3,5	16	≤ 1,5	10,9	27.000	5.200

03

Blind rivet nuts

Flat round head, aluminium



Item no.	Female thread	Rivetable material thickness	Bore hole Ø mm
5948-14-20	M4	0,5 - 3,0	6,0
5948-15-30	M5	0,5 - 3,0	7,0
5948-16-30	M6	0,5 - 3,0	9,0
5948-18-30	M8	0,5 - 3,0	11,0
5948-18-55	M8	3,0 - 5,5	11,0
5948-10-175	M10	3,0 - 6,0	13,0

**CAUTION
TABLES SPREAD
ACROSS THE
ENTIRE PAGE**

01

Assortment of blind rivets

DIN 7337, rivet body: Aluminium alloy, rivet mandrel: galvanised steel

► Item no. 1957-937-1

Contents: 800 parts

- 100 x 3x6 (art. no. 5937-3-6)
- 100 x 3x8 (art. no. 5937-3-8)
- 100 x 4x10 (art. no. 5937-4-10)
- 100 x 4x12 (art. no. 5937-4-12)
- 100 x 4x6 (art. no. 5937-4-6)
- 100 x 4x8 (art. no. 5937-4-8)
- 100 x 3x10 (art. no. 5937-3-10)
- 100 x 4x16 (art. no. 5937-4-16)



01

02

Blind rivet nut assortment

Aluminium

► Item no. 1957-948

Contents: 600 parts

- 100 x M4x6 Alu (art. no. 5948-14-20)
- 100 x M5x7 Alu (art. no. 5948-15-30)
- 50 x M6x9 Alu (art. no. 5948-16-30)
- 50 x M8x11 Alu (art. no. 5948-18-30)
- 100 x M4x6 Steel (art. no. 5949-4-115)
- 100 x M5x7 Steel (art. no. 5949-5-12)
- 50 x M6x9 Steel (art. no. 5949-6-145)
- 50 x M8x11 Steel (art. no. 5949-8-185)



02

03

Blind riveting tool

For diameters up to 4.8 mm

► Item no. 8949-50

- Product description
- Head type: 360° rotating
 - Length: 250 mm
 - Width: 355 mm
 - Height: 30 mm
 - Weight: 0.818 kg



03

04

Manual riveting pliers

Working area up to 5 mm Ø

► Item no. 8949-11

- Product description
- Weight: 1.85 kg
 - Total length: 570 mm
 - Stroke: 10 mm
 - Working range: diameters up to 5 mm for aluminium and 4 mm for stainless steel
 -
 - Equipment and accessories:
 - Nosepieces 10/18, 10/24, 10/32
 - Installation wrench



04

05

Lever riveting device

For diameters up to 6.4 mm

► Item no. 8949-20

- Product description
- Weight: 1.85 kg
 - Total length: 570 mm
 - Stroke: 10 mm
 - Working range: diameters up to 6.4 mm for all materials
 -
 - Equipment and accessories:
 - - Nosepieces 16/29, 16/32, 16/36, 16/40, 16/45
 - - Spent mandrel container



05

06

Blind rivet nut pliers

incl. M6, M8, M10, M12 thread pins and nuts

► Item no. 8948-800

- Product description
- For processing blind rivet nuts, M6 M12, aluminium/steel/stainless steel



06

07

Mandrel and nut

for blind rivet nut pliers 8948-800

- Item no. 8948-800-14
- M4
- Item no. 8948-800-15
- M5
- Item no. 8948-800-16
- M6
- Item no. 8948-800-18
- M8
- Item no. 8948-800-110
- M10
- Item no. 8948-800-112
- M12



07

Abbreviations for clips and clamps

Material

Code	Designation	Code	Designation
1.4301	Stainless steel 1.4301	PA 623	Polyamide 623
1.4303	Stainless steel 1.4303	PA 66	Polyamide 66
1.4310	Stainless steel 1.4310	PA 661	Polyamide 661
1.4401	Stainless steel 1.4401	PA 662	Polyamide 662
1.4405	Stainless steel 1.4405	PA 668	Polyamide 668
A2	Stainless steel A2	PA GF	Polyamide fibreglass-reinforced
A4	Stainless steel A4	PBT HI	Polybutylene terephthalate HI
ABS	Acrylonitrile butadiene styrene	PE	Polyethylene
AL	Aluminium	PE 181	Polyethylene 181
C 45	Spring steel C 45	PE 271	Polyethylene 271
C 75	Spring steel C 75	PE 302	Polyethylene 302
CK 67	Spring steel CK 67	PE 750	Polyethylene 750
CU	Copper	PE HD	Polyethylene high density
CUSN	Bronze	PE LD	Polyethylene low density
CUZN	Brass	PEE 526	Polyether ester 526
EBA	Ethylene butylacrylate copolymer	PEE 724	Polyether ester 724
KOMBI	Combi-material	PES	Polyester
M	Q&T steel	POM 509	Polyoxymethylene 509
PA	Polyamide	PP	Polypropylene
PA 12	Polyamide 12	PPN	Polypropylene
PA 122	Polyamide 122	PPO	Polyphenylene oxide
PA 124	Polyamide 124	PVC	Polyvinylchloride
PA 6	Polyamide 6	SEBS	Styrene-ethene-butene-styrene
PA 601	Polyamide 601	TPC	Thermoplastic copolyester
PA 607	Polyamide 607	TPE	Thermoplastic elastomer
PA 622	Polyamide 622	UP	Unsaturated polyester
		VELOUR PA	Velours polyamide

Colour

Code	Designation	Code	Designation
ANT	Anthracite	L	Purple
B	Blue	N	Neutral
BE	Beige	OR	Orange
BL Natural colour		R	Red
BR	Brown	RO	Pink
DG	Dark grey	S	Black
G	Grey	W	White
GR	Green	Y	Yellow
HG	Light grey		

Abbreviations for clips and clamps

Surface metal

Code	Designation	Code	Designation
BL Natural colour		NI	Nickel-plated
BR	Burnished	OX	Oxidised
CHEM SW	Chemically dyed black	PA BES.PA	Coated unsmoothed
CR	Chrome-plated	PHO	Phosphated
DAC	Dacromet	PHO GEÖLT	Phosphated oiled
DELTA PROT	Delta Protpekt	PHO IMP	Phosphated impregnated
DELTA SEAL	Delta Seal	PHO LACK	Phosphated painted
GEBEIZT	Stained	PHO LACK SW	Phosphated painted black
GEBÖRDELT	Flanged	PHO LACK SW IMP	Phosphated painted black impregnated
GEO 321	Geomet 321	PHO PARAF	Phosphated paraffined
GEÖLT	Oiled	PHO SW	Phosphated black
GL	Shiny	POL	Polished
GZ	Gliding additive	ROH	Raw
IMP	Impregnated	SI	Silver
LACK	Painted	SN	Tin-plated
MAGNI 565	MAGNI 565 silver	TAUCHPARAF	Dip-paraffined
MAGNI 511	MAGNI 511	VK	Copper-plated
MIC 200	Microcor 200	VZ	Zinc-plated
MKB ANT MKB	anthracite	VZ FL	Zinc-plated colourless
MKB SI MKB	(metal-containing anti-corrosion coating silver)	VZ FL NTL	Zinc-plated colourless post-dip solution
MKB SI GZ MKB	(metal-containing anti-corrosion coating) silver	VZ FL PASS	Zinc-plated colourless passivated
MKB SW MKB	(metal-containing anti-corrosion coating) black	VZ FL PASS MATT	Zinc-plated colourless passivated matt
MKB SW GZ MKB	(metal-containing anti-corrosion coating) black	VZ GL	Zinc-plated shiny
		VZ MATT	Zinc-plated matt
		VZ NTL	Zinc-plated post-dip solution
		VZG3	Zinc-plated yellow chrome-3
		VZS3	Zinc-plated black chrome-3
		VZSO	Zinc-plated organic black
		ZN FE SW	Zinc iron black
		ZN NI	Zinc nickel

Chevrolet, Daewoo clips & clamps

Item no.	Item description	Original No. 1	Original No. 2	Illustration
5501-103-015	Plastic expanding rivet Ø 8.0 Mm Pa 6 black	90138810		
5501-107-105	Cover plug Ø 6.3 - 6.7 Mm Pa 66 black	A0009881128		
5501-103-011	Pom interior trim clip white	2345957	90321122	
5501-103-073	Door frame clip black	134786	90044397	

Chrysler clips & clamps

Item no.	Item description	Original No. 1	Original No. 2	Illustration
6242-12-15	Locking screw M14 X 1.5 X 20 Sw 13 Pho / Nbr*	11.137.513.050		

Daihatsu clips & clamps

Item no.	Item description	Original No. 1	Original No. 2	Illustration
5500-774-7	Expanding nut Pa 6 black*	9018906013		

Citroën, Peugeot clips & clamps

Item no.	Item description	Original No. 1	Original No. 2	Illustration
5501-107-141	Door gasket clip Pa 662 black	7701044547		
6464-16-24	Sealing ring metal / rubber 13.0 X 24.0 X 2.5 Vz*	1.005.578	6.157.668	
6243-14-159	Locking screw M14 X 1.5 X 21 Sw 13 Pho*	1.013.938	97JM6730BA	
6464-10-10	Copper sealing ring 10.2 X 20.0 X 2.0	1.145.962		
5500-110-31	Wheel bolt M12 X 1.5 x 20 Mm Sw 17 Geomet silver*	90942W2001		
6362-112-15	Wheel nut M12 x 1.5 Sw 21 Vz*-3*	30.873.148		
5500-110-39	Plastic rivets without pin Ø 6.2 Mm Pom black	7703077078		
5500-110-18	Plastic expanding rivet Ø 6.0 Mm Pa 66 black	697346	6990C4	
5500-110-30	Screw M6 x 20 Sw 10 Dacromet Si	697404		
5500-110-7	Cover plug Ø 6.5 Mm Pa 6 black	699295	6999R2	
5500-110-1	Fir tree clip Ø 6.5 Mm Pa 66 black	7703077066		
5500-110-19	Plastic expanding rivet Ø 6.50 Mm Pa 661 black	699783	6997T2	
5500-110-9	Cover plug Ø 8.0 X 5.0 Mm Pom black	699786	9619769080	
5500-110-35	Screw cap Geomet silver	703016	9632676980	
5500-110-40	Screw cap mount Geomet Si	703018	9632677180	







Citroën, Peugeot clips & clamps

Item no.	Item description	Original No. 1	Original No. 2	Illustration
5500-110-13	Plastic expanding rivet Ø 8.0 - 8.2 Mm Pa 6 black	A1239900292		
5501-107-140	Rod holder Ø 8.0 Mm Pom black	792831		
5500-110-28	Interior trim clip Ø 8.2 Mm Pa 66 neutral with seal	811024		
5501-107-110	Interior trim clip Ø 9.5 Mm Pom black	856535		
5500-110-27	Interior trim clip Ø 8.0 Mm Pom neutral	7701049270		
5501-107-113	Interior trim clip Ø 8.0 Mm neutral with seal black	856543		
5501-107-112	Decorative trim clip Pom white	856548		
5501-107-139	Decorative trim clip Pom neutral	856558		
5500-939-5	Fir tree clip Ø 7.2 Mm Pa 66 dark grey	2338955	90431553	
5500-124-28	Plastic expanding rivet Ø 5.0 - 5.2 Mm Pa 122 black*	A0009900392	A0009902292	
5500-523-14	Plastic expanding rivet Ø 5.0 - 5.5 Mm Pa 6 black	N10259301	1L0853934	
5500-110-38	Cable clamp Ø 9.0 Mm Pa 6 grey	7703079070		
5500-001-191	Cable clamp Ø 17.0 Mm Pa 6 neutral			
5500-110-15	Plastic expanding rivet Ø 4.0 - 4.2 Mm Pom 902 black	A0019902492		
5501-060-90	Expanding nut St. 4.2 Mm Pa 661 neutral	441035555		



Citroën, Peugeot clips & clamps

Item no.	Item description	Original No. 1	Original No. 2	Illustration
5500-110-34	Drive rivet Ø 6.2 Mm Pa 6 / Pom black	8N8868307		
5500-110-33	Drive rivet Ø 6.2 Mm Pa 66 / Pom black	7703072327		
5500-110-16	Plastic expanding rivet Ø 7.8 - 8.8 Mm Pa 66 black	N10583501		
5500-110-12	Plastic expanding rivet Ø 8.0 - 8.2 Mm Pa 6 black	99950749740		
5500-110-20	Plastic expanding rivet Ø 8.05 - 8.30 Mm Pa 66 black	9648975680	856553	
5500-110-32	Drive rivet Ø 6.2 Mm Pa 6 / Pom black	7L6868307	8Z0857784	
5501-132-004	Plastic expanding rivet Ø 8.0 Mm Pom / Pa Gf black*	9046708185		
5501-130-055	Plastic expanding rivet Ø 7.0 Mm Pbt / Pom black*	9046707166		
5500-110-25	Interior trim clip Pom neutral	8E9867299		
5500-110-26	Interior trim clip Ø 8.2 Mm Pom FI with rubber lip Sw	7703077469		
5501-107-127	Interior trim clip Ø 8.2 Mm Pom blue	51139804996		
5500-110-8	Cover plug Ø 4.7 Mm Pa 66 black	6992K8	6999A3	
5500-110-29	Interior trim clip Ø 8.0 Mm Pom black	6995S0		
5500-110-2	Cover plug Ø 6.7 Mm Pom black	7703077068		
5500-110-37	Percussion rivet Ø 8.1 - 8.3 Mm Pa 66 black	7013J0	8211WV	



Citroën, Peugeot clips & clamps

Item no.	Item description	Original No. 1	Original No. 2	Illustration
5501-107-105	Cover plug Ø 6.3 - 6.7 Mm Pa 66 black	A0009881128		
5500-110-4	Cover plug Ø 10.2 Mm Pe black	7703077225		
5501-128-50	Interior trim clip Ø 8.2 X 8.2 Mm blue + A2 clip	1222141	24405740	
5500-110-17	Plastic expanding rivet Ø 4.55 X 5.15 Mm Pom black	A0019901392		
6464-128-225	Ford gasket 12.8 X 22.5 X 3.0 Nbr 70 black	1.005.593		
5500-110-6	Cover plug for 5.0 threaded bolts Pp black	6142789		



Hyundai clips & clamps

Item no.	Item description	Original No. 1	Original No. 2	Illustration
6362-112-15	Wheel nut M12 x 1.5 Sw 21 Vzg-3*	30.873.148		
5500-785-045	Expanding nut M4 Pe neutral with foam ring*	9751922000		





Honda clips & clamps

Item no.	Item description	Original No. 1	Original No. 2	Illustration
6464-114-22	Aluminium ring simil. Din 7603A, 14.0 X 22.0 X 2.0	2.151.323.000	K995641400	
5500-771-0	Expanding nut neutral*	9018904014		
5500-785-082	Door gasket clip Pa 6 neutral*	90664671003		
5500-785-021	Plastic rivet without pin black*	90672671003		
5501-129-003	Percussion rivet Pom black*	9046707164		
5500-785-045	Expanding nut M4 Pe neutral with foam ring*	9751922000		
5500-785-087	Drive rivet Pa 66 black*	9046708145		
5500-785-083	Drive rivet Ø 6.0 Mm Pa 6 black*	5578552020		
5501-129-013	Percussion rivet Pom black*	91501S04003	91512S04003	
5501-129-001	Plastic expanding rivet Ø 10.0 X 10.2 Mm Pp / Pom black*	91503SZ3003		







Jaguar clips & clamps

Item no.	Item description	Original No. 1	Original No. 2	Illustration
6464-128-225	Ford gasket 12.8 X 22.5 X 3.0 Nbr 70 black	1.005.593		
6243-14-159	Locking screw M14 X 1.5 X 21 Sw 13 Pho*	1.013.938	97JM6730BA	









Kia clips & clamps

Item no.	Item description	Original No. 1	Original No. 2	Illustration
6464-114-22	Aluminium ring simil. Din 7603A, 14.0 X 22.0 X 2.0	2.151.323.000	K995641400	
6362-112-15	Wheel nut M12 x 1.5 Sw 21 Vz3-3*	30.873.148		
5500-785-045	Expanding nut M4 Pe neutral with foam ring*	9751922000		
5500-777-3	Drive rivet Ø 6.2 - 7.0 Mm Pa 6 black*	9046706017		







Land Rover clips & clamps

Item no.	Item description	Original No. 1	Original No. 2	Illustration
6243-14-159	Locking screw M14 X 1.5 X 21 Sw 13 Pho*	1.013.938	97JM6730BA	
6464-128-225	Ford gasket 12.8 X 22.5 X 3.0 Nbr 70 black	1.005.593		
6464-16-24	Sealing ring metal / rubber 13.0 X 24.0 X 2.5 Vz*	1.005.578	6.157.668	
5500-110-23	Interior trim clip Ø 8.2 Mm Pom neutral / yellow	4414720	93176656	
6243-14-15	Locking screw M14 X 1.5 X 16 Sw 13 blank oiled	1.454.117	6.732.529	
6243-12-15	Locking screw M12 X 1.5 X 18 Sw 17 Vz*	11.131.273.093		







Mazda clips & clamps

Item no.	Item description	Original No. 1	Original No. 2	Illustration
6362-112-15	Wheel nut M12 x 1.5 Sw 21 Vz3-3*	30.873.148		
6464-128-225	Ford gasket 12.8 X 22.5 X 3.0 Nbr 70 black	1.005.593		
5500-789-051	Plastic rivets without pin Ø 3.2 - 3.6 Mm Pa 6 black*			
5500-788-028	Plastic rivets without pin Ø 6.0 Mm Pa 6 black*	155300291		
6243-14-159	Locking screw M14 X 1.5 X 21 Sw 13 Pho*	1.013.938	97JM6730BA	
5501-131-004	Percussion rivet black*	B46768AC3		
5501-131-002	Drive rivet black*	NA0156145		
6464-10-10	Copper sealing ring 10.2 X 20.0 X 2.0	1.145.962		

Mitsubishi clips & clamps

Item no.	Item description	Original No. 1	Original No. 2	Illustration
5500-405-0	Interior trim clip Ø 8.1 - 8.5 Mm Pom neutral	2E0867059		
5500-201-404	Plastic expanding rivet Ø 8.0 - 8.2 Mm Pa 6 black	A2019900292	A2019900292/9051	
6362-112-15	Wheel nut M12 x 1.5 Sw 21 Vzg-3*	30.873.148		
5500-777-3	Drive rivet Ø 6.2 - 7.0 Mm Pa 6 black*	9046706017		
5501-130-010	Percussion rivet Pom / Ppo black*	9046707041		
5501-132-003	Plastic expanding rivet Ø 8.0 - 8.2 Mm Pom / Pp Gf 20 black*	155309321		

Nissan clips & clamps

Item no.	Item description	Original No. 1	Original No. 2	Illustration
5500-788-026	Expanding nut neutral*	9018906001		
5500-788-001	Plastic rivet without pin black*	155300172		
5500-788-028	Plastic rivets without pin Ø 6.0 Mm Pa 6 black*	155300291		
5501-132-005	Plastic expanding rivet Ø 10.0 Mm Pa 6 / Pom black*	57728AC090		
5501-132-003	Plastic expanding rivet Ø 8.0 - 8.2 Mm Pom / Pp Gf 20 black*	155309321		
5501-132-004	Plastic expanding rivet Ø 8.0 Mm Pom / Pa Gf black*	9046708185		





Nissan clips & clamps

Item no.	Item description	Original No. 1	Original No. 2	Illustration
5500-110-36	Percussion rivet Ø 8.2 Mm Pom / Pa 66 Gf 13 black with slot	7703072360		
5501-132-002	Drive rivet black*	6385401A00	6384401A00	
5501-132-006	Drive rivet black*	6686001W01		

Porsche clips & clamps

Item no.	Item description	Original No. 1	Original No. 2	Illustration
5501-107-130	Plastic nut 5.0 Pa 66 Gf 30 black	WHT003207		
5500-110-12	Plastic expanding rivet Ø 8.0 - 8.2 Mm Pa 6 black	99950749740		
5501-107-103	Interior trim clip Ø 7.9 - 8.0 Mm Pom neutral	51411973500		
5500-110-34	Drive rivet Ø 6.2 Mm Pa 6 / Pom black	8N8868307		
5500-113-21	Sheet nut St. 4.2 Mm Pho paint yellow	2072030	11074201	
5500-121-9	Sheet nut St. 3.5 Mm Vz FI Pass	1474663		
5500-032-290	Sheet nut St. 4.8 Mm self-tapping Mkb 2.0 Si	E824123S71		
5500-150-21	Grommet Pa 6 red	A0019882081		
5500-113-62	Sheet nut St. 4.2 Mm Vz FI Pass	N0154292		

Porsche clips & clamps

Item no.	Item description	Original No. 1	Original No. 2	Illustration
5500-156-1	Sheet nut St. 4.2 Mm Vz FI Pass	211837223	N0154301	
5500-114-70	Sheet nut St. 4.8 Mm Vz FI Pass matt	N0154581		
5500-130-11	Plastic expanding rivet Ø 7.9 - 8.5 Mm Pa 66 black	16186729901C	N038549101C	
5501-107-114	Expanding nut St. 4.8 Mm Pa 6 neutral with rubber lip black	N10516801		
6243-14-161	Locking screw M14 X 1.5 X 22 Sw 19 Zn Ni*	N90813201	N90813202	

Renault clips & clamps

Item no.	Item description	Original No. 1	Original No. 2	Illustration
5501-107-141	Door gasket clip Pa 662 black	7701044547		
5500-110-27	Interior trim clip Ø 8.0 Mm Pom neutral	7701049270		
5500-110-14	Removable plastic expanding rivet Pa 66 black	8E0825267		
5500-110-25	Interior trim clip Pom neutral	8E9867299		
5500-110-10	Sheet nut M8 Vz FI Pass	7703046020		
5500-032-010	Sheet nut M6 Mkb 2.2 Si Gz	N90168602		
5500-113-62	Sheet nut St. 4.2 Mm Vz FI Pass	N0154292		



Renault clips & clamps

Item no.	Item description	Original No. 1	Original No. 2	Illustration
5500-110-11	Plastic expanding rivet Ø 5.0 - 5.6 Mm Pa 12 black*	7703072144		
5500-127-10	Plastic expanding rivet Ø 5.9 - 7.1 Mm Pa 6 black	N0385012		
5500-124-28	Plastic expanding rivet Ø 5.0 - 5.2 Mm Pa 122 black*	A0009900392	A0009902292	
5500-110-15	Plastic expanding rivet Ø 4.0 - 4.2 Mm Pom 902 black	A0019902492		
5500-110-32	Drive rivet Ø 6.2 Mm Pa 6 / Pom black	7L6868307	8Z0857784	
5500-110-34	Drive rivet Ø 6.2 Mm Pa 6 / Pom black	8N8868307		
5500-110-33	Drive rivet Ø 6.2 Mm Pa 66 / Pom black	7703072327		
5500-110-36	Percussion rivet Ø 8.2 Mm Pom / Pa 66 Gf 13 black with slot	7703072360		
5500-145-84	Plastic expanding rivet Ø 8.0 - 8.2 Mm Pa 12 black	N90229301		
5500-110-1	Fir tree clip Ø 6.5 Mm Pa 66 black	7703077066		
5500-110-2	Cover plug Ø 6.7 Mm Pom black	7703077068		
5500-110-39	Plastic rivets without pin Ø 6.2 Mm Pom black	7703077078		
5500-110-5	Cover plug Ø 8.2 Mm Pa 66 black	7703077153		
5500-110-4	Cover plug Ø 10.2 Mm Pe black	7703077225		
5501-107-135	Cover plug Ø 8.2 Mm Pa 66 dark grey	A6389841661	A6389840061	

Renault clips & clamps

Item no.	Item description	Original No. 1	Original No. 2	Illustration
5500-110-23	Interior trim clip Ø 8.2 Mm Pom neutral / yellow	4414720	93176656	
5501-107-107	Decorative trim clip Pom pink	7703077421		
5501-912-50	Decorative trim clip grey	93160023	4409693	
5500-110-24	Interior trim clip Ø 8.2 Mm Pom neutral / grey	4414667	91169651	
5500-110-3	Fir tree clip Ø 10.2 - 10.7 Mm Pe Ld black	7703077435		
5500-110-26	Interior trim clip Ø 8.2 Mm Pom FI with rubber lip Sw	7703077469		
5501-128-50	Interior trim clip Ø 8.2 X 8.2 Mm blue + A2 clip	1222141	24405740	
5500-110-38	Cable clamp Ø 9.0 Mm Pa 6 grey	7703079070		
5500-001-191	Cable clamp Ø 17.0 Mm Pa 6 neutral			
5500-110-6	Cover plug for 5.0 threaded bolts Pp black	6142789		
5500-110-21	Expanding nut St. 4.5 Mm Pa 66 natural	7703081184		
5501-107-142	Expanding nut St. 4.2 / 4.5 Mm Pa 66 Gf 30 FI with rubber lip	7703081232		
5500-110-22	Interior trim clip Pom neutral / green	8200702219	7701049008	
6464-10-10	Copper sealing ring 10.2 X 20.0 X 2.0	1.145.962		
5500-523-14	Plastic expanding rivet Ø 5.0 - 5.5 Mm Pa 6 black	N10259301	1L0853934	





Saab clips & clamps

Item no.	Item description	Original No. 1	Original No. 2	Illustration
5501-103-015	Plastic expanding rivet Ø 8.0 Mm Pa 6 black	90138810		
5500-130-11	Plastic expanding rivet Ø 7.9 - 8.5 Mm Pa 66 black	16186729901C	N038549101C	
6464-15-15	Copper sealing ring 15.5 X 24.0 X 2.0	109.132.937		

Subaru clips & clamps

Item no.	Item description	Original No. 1	Original No. 2	Illustration
5501-129-003	Percussion rivet Pom black*	9046707164		
5500-774-7	Expanding nut Pa 6 black*	9018906013		
5501-132-005	Plastic expanding rivet Ø 10.0 Mm Pa 6 / Pom black*	57728AC090		

Suzuki clips & clamps

Item no.	Item description	Original No. 1	Original No. 2	Illustration
5501-129-003	Percussion rivet Pom black*	9046707164		
5500-777-3	Drive rivet Ø 6.2 - 7.0 Mm Pa 6 black*	9046706017		
6243-14-160	Locking screw M14 X 1.5 X 10 Tx45 Zn Ni*	90502556	96023264	
6464-18-2	Sealing ring 18.0 X 22.0 X 2.0 Nbr 70 black	652540	90528145	
6395-312-15	Wheel bolt M12 X 1.5 x 21 Mm Sw 17 Vz FI*	90.473.457	1.008.504	

Toyota, Lexus clips & clamps

Item no.	Item description	Original No. 1	Original No. 2	Illustration
5501-130-024	Percussion rivet Ø 8.9 - 9.1 Mm Pom / Pbt black*	5216116010		
5500-779-3	Sheet nut plastic black*	5387914010		
5500-785-083	Drive rivet Ø 6.0 Mm Pa 6 black*	5578552020		
5500-771-0	Expanding nut neutral*	9018904014		
5500-788-026	Expanding nut neutral*	9018906001		
5500-775-8	Expanding nut Pa 6 neutral*	9018906006		
5500-771-4	Expanding nut neutral*	9018906010		

Toyota, Lexus clips & clamps

Item no.	Item description	Original No. 1	Original No. 2	Illustration
5500-774-7	Expanding nut Pa 6 black*	9018906013		
5500-777-3	Drive rivet Ø 6.2 - 7.0 Mm Pa 6 black*	9046706017		
5501-130-010	Percussion rivet Pom / Ppo black*	9046707041		
5501-130-009	Percussion rivet black*	9046707066		
5501-129-003	Percussion rivet Pom black*	9046707164		
5501-130-055	Plastic expanding rivet Ø 7.0 Mm Pbt / Pom black*	9046707166		
5500-785-087	Drive rivet Pa 66 black*	9046708145		
5501-132-004	Plastic expanding rivet Ø 8.0 Mm Pom / Pa Gf black*	9046708185		
5501-130-008	Percussion rivet black*	9046710183	9046707183	
5500-771-6	Plastic rivets without pin Ø 4.8 - 5.0 Mm black*			
6362-112-15	Wheel nut M12 x 1.5 Sw 21 Vzg-3*	30.873.148		
5500-110-31	Wheel bolt M12 X 1.5 x 20 Mm Sw 17 Geomet silver*	90942W2001		
6464-10-10	Copper sealing ring 10.2 X 20.0 X 2.0	1.145.962		

Fiat, Alfa Romeo, Lancia, IVECO clips & clamps

Item no.	Item description	Original No. 1	Original No. 2	Illustration
5501-106-095	Metal clamp holder for window crank oiled	136511	6235332	
5501-107-118	Fir tree clip Ø 6.5 Mm Pa 66 black	4274360		
5500-117-51	Grommet Pa 6 red	A0009881581		
5501-107-115	Plastic expanding rivet Ø 8.0 Mm Pa 6 black	7600779		
5500-032-010	Sheet nut M6 Mkb 2.2 Si Gz	N90168602		
5500-110-38	Cable clamp Ø 9.0 Mm Pa 6 grey	7703079070		
5501-107-117	Fir tree clip Ø 6.5 Mm Pa 6 black	14591687		
5501-107-130	Plastic nut 5.0 Pa 66 Gf 30 black	WHT003207		
6395-312-15	Wheel bolt M12 X 1.5 x 21 Mm Sw 17 Vz FI*	90.473.457	1.008.504	
5501-103-015	Plastic expanding rivet Ø 8.0 Mm Pa 6 black	90138810		
6464-185-26	Sealing ring metal / rubber 18.5 X 26.0 X 2.5 Vz3*	652.543	93.183.670	
6243-18-15	Locking screw M18 X 1.5 X 21 Sw 13 Vz	652.950	93.183.669	
5501-105-005	Decorative trim clamp Pom yellow with green grommet Tpe	51138166675		
5501-107-113	Interior trim clip Ø 8.0 Mm neutral with seal black	856543		

Fiat, Alfa Romeo, Lancia, IVECO clips & clamps

Item no.	Item description	Original No. 1	Original No. 2	Illustration
5500-110-27	Interior trim clip Ø 8.0 Mm Pom neutral	7701049270		
6464-011-212	Sealing ring 11.0 X 21.0 X 2.5 Nbr 70 black	652.526	3.536.966	
6243-12-160	Locking screw M12 X 1.75 X 25 Sw 15 Vz*	4.948.795	9L8E6730AA	
6464-18-2	Sealing ring 18.0 X 22.0 X 2.0 Nbr 70 black	652540	90528145	
5501-129-003	Percussion rivet Pom black*	9046707164		
6243-14-160	Locking screw M14 X 1.5 X 10 Tx45 Zn Ni*	90502556	96023264	
5500-337-20	Interior trim clip Ø 8.0 - 8.4 Mm Pom black / neutral	1020732		
5501-912-50	Decorative trim clip grey	93160023	4409693	
5501-103-035	Plastic expanding rivet Ø 5.5 - 6.4 Mm Pa 661 black	N10219501	N10219502	
5501-107-116	Fir tree clip Ø 6.5 Mm Pa 6 grey	712113631		
5500-110-8	Cover plug Ø 4.7 Mm Pa 66 black	6992K8	6999A3	
5500-110-19	Plastic expanding rivet Ø 6.50 Mm Pa 661 black	699783	6997T2	
5500-110-26	Interior trim clip Ø 8.2 Mm Pom FI with rubber lip Sw	7703077469		

Clips Opel

Item no.	Item description	Original No. 1	Original No. 2	Illustration
5500-500-08	Upholstery clamp Vk	100490	6616858	
5501-103-073	Door frame clip black	134786	90044397	
5501-106-095	Metal clamp holder for window crank oiled	136511	6235332	
5501-103-072	Decorative trim clamp Vz FI	154923	90503290	
5500-010-060	Door gasket clip Pa 665 neutral	704948		
5501-101-205	Interior trim clip Pom black with grommet Pe-Ld neutral	1H0837719		
5500-124-28	Plastic expanding rivet Ø 5.0 - 5.2 Mm Pa 122 black*	A0009900392	A0009902292	
5501-105-005	Decorative trim clamp Pom yellow with green grommet Tpe	51138166675		
5501-103-007	Decorative trim clamp Pom neutral wheel case cover	174854	90481595	
5501-103-002	Decorative trim clamp for stone chip protection white	174977	90062798	
5500-115-691	Sealing clip	176651		
5501-107-137	Roof decorative trim clamp Pom black	187918	9185662	
5501-107-138	Roof decorative trim clamp Pom black	188551	9114735	
5501-129-20	Decorative trim clamp Pom black	188581	90580920	
6243-12-15	Locking screw M12 X 1.5 X 18 Sw 17 Vz*	11.131.273.093		

Clips Opel

Item no.	Item description	Original No. 1	Original No. 2	Illustration
6464-011-212	Sealing ring 11.0 X 21.0 X 2.5 Nbr 70 black	652.526	3.536.966	
6464-18-2	Sealing ring 18.0 X 22.0 X 2.0 Nbr 70 black	652540	90528145	
6464-185-26	Sealing ring metal / rubber 18.5 X 26.0 X 2.5 Vz3-3*	652.543	93.183.670	
6243-18-15	Locking screw M18 X 1.5 X 21 Sw 13 Vz	652.950	93.183.669	
5501-104-053	Prestole cage nut St. 4.8 Mm Mkb Si	A0019949845	90270271	
6365-6	Flange nut M8 Sw 13 H 10 Vk*	854906	90080883	
6365-65	Flange nut M10 Sw 15 H 10 Vk*	854976	90108169	
6129-63-16	Combi screw 7976 6.3X16 washer 1.6 x 22 Vz FI*	1.101.412	9.287.493	
5500-130-11	Plastic expanding rivet Ø 7.9 - 8.5 Mm Pa 66 black	16186729901C	N038549101C	
5501-104-038	Plastic expanding rivet Ø 8.0 - 8.6 Mm Pa 12 black	N10032301		
5501-103-068	Plastic expanding rivet Ø 8.0 - 8.6 Mm Pa 661 black*	N10552001		
5501-107-136	Prestole cage nut St. 6.3 Mm Mkb Si Gz	1110936	13154960	
5500-402-9	Fir tree clip Pe black	1162484	90040750	
5501-103-070	Rod holder Ø 7.0 Mm Pa 66 black	1180181	9114314	
5500-151-97	Hilo expanding nut 5.8 Mm Pa 6 neutral	1216957	90230960	

Clips Opel

Item no.	Item description	Original No. 1	Original No. 2	Illustration
5501-103-027	Headlight mount Pom neutral	1217801	90321482	
5501-103-004	Headlight mount Pom 130 neutral	1218601	90181010	
5501-128-50	Interior trim clip Ø 8.2 X 8.2 Mm blue + A2 clip	1222141	24405740	
5501-103-019 Pa 66 black*	Cable tie 119 X 9.7 Mm 1288885	90381846		
5501-103-078	Cable tie 115 X 4.8 Mm with foot Pa 66 natural*	1288888	90461994	
5501-103-009	Expanding nut St. 4.8 Mm Pa 6 natural	1320979	90246677	
5501-105-065	Plastic expanding rivet Ø 6.0 - 6.2 Mm Pa 66 black	1400804	90414659	
5501-103-017	Plastic expanding rivet Ø 6.0 - 6.2 Mm Pa 66 black	1400806	90508809	
5501-103-021	Sheet nut M5 self-tapping Vz FI Pass	1400906	90464538	
5501-107-100	Blind rivet 4.0 X 14.0 alu / steel	1406528	90589346	
5501-103-020	Sheet nut St. 6.3 Mm self-tapping Mkb 2.0 Si	1406970	90158565	
5500-127-10	Plastic expanding rivet Ø 5.9 - 7.1 Mm Pa 6 black	N0385012		
5501-103-015	Plastic expanding rivet Ø 8.0 Mm Pa 6 black	90138810		
6129-48-19	Combi screw 7976 4.8X19 washer 1.5 x 15 Vz FI*	7119916949		
6129-55-16	Combi screw 7976 5.5X16 washer 1.6 x 15 Vz FI*	2022107	11077982	







Clips Opel

Item no.	Item description	Original No. 1	Original No. 2	Illustration
6129-63-25	Combi screw 7976 6.3X25 washer 1.6 x 18 Vz FI*	2022209	11074862	
6103-055-16	Number plate screw 7981 5.5 X 16 Mm Vz FI*	2038251		
6103-055-19	Number plate screw 7981 5.5 X 19 Mm Vz FI*	2.038.253	11.067.771	
6103-055-25	Number plate screw 7981 5.5 X 25 Mm Vz FI*	2.038.261	11.068.913	
5501-103-022	Washer nut M6 Vz	N910104006000		
5501-105-079	Washer nut M8 Vz blue Cr-3	51111835625	51117070183	
6365-61	Flange nut M8 Sw 13 H 8 self-tapping Vk*	1448187		
5500-113-21	Sheet nut St. 4.2 Mm Pho paint yellow	2072030	11074201	
5500-115-77	Sheet nut St. 5.5 Mm Vz FI Pass	7129925720		
5500-132-04	Sheet nut St. 6.3 Mm half Vz FI Pass	2072153	11072461	
5500-121-6	Blind rivet 4.8 X 11.0 steel / steel	2084170	11086102	
5501-105-601	Fir tree clip Ø 8.0 - 8.5 Mm Pe Ld black	N90201601		
5501-129-10	Interior trim clip Ø 8.0 - 20.0 Mm Pom black + A2 clip	2228839	24405739	
5500-136-31	Interior trim clip Ø 7.3 - 7.5 Mm Pa 66 black	2240587	2240593	
5500-897-33	Expanding nut St. 4.8 Mm Pa 6 Gf 30 black	811807577F		

Clips Opel

Item no.	Item description	Original No. 1	Original No. 2	Illustration
5500-127-09	Fir tree clip Pe black	2240861	90022049	
5501-103-035	Plastic expanding rivet Ø 5.5 - 6.4 Mm Pa 661 black	N10219501	N10219502	
5501-103-071	Cover plug black	2336960	90431606	
5500-939-5	Fir tree clip Ø 7.2 Mm Pa 66 dark grey	2338955	90431553	
5500-939-6	Fir tree clip Ø 7.0 - 7.2 Mm Pa 66 black	A0009912895		
5501-103-011	Pom interior trim clip white	2345957	90321122	
5501-103-012	Interior trim clip Pom red	2345959	90457899	
5500-110-24	Interior trim clip Ø 8.2 Mm Pom neutral / grey	4414667	91169651	
5500-110-23	Interior trim clip Ø 8.2 Mm Pom neutral / yellow	4414720	93176656	
5500-110-14	Removable plastic expanding rivet Pa 66 black	8E0825267		
5501-107-105	Cover plug Ø 6.3 - 6.7 Mm Pa 66 black	A0009881128		
5501-103-069	Plastic expanding rivet dark grey	7336931	13105583	
6243-12-160	Locking screw M12 X 1.75 X 25 Sw 15 Vz*	4.948.795	9L8E6730AA	
6395-312-15	Wheel bolt M12 X 1.5 x 21 Mm Sw 17 Vz FI*	90.473.457	1.008.504	
6243-14-160	Locking screw M14 X 1.5 X 10 Tx45 Zn Ni*	90502556	96023264	















Clips Opel

Item no.	Item description	Original No. 1	Original No. 2	Illustration
5501-912-50	Decorative trim clip grey	93160023	4409693	
5500-114-27	Sheet nut St. 6.3 Mm Vz FI Pass	1470998		
5500-113-69	Sheet nut St. 6.5 Mm Vz FI Pass	803821117		
5500-307-71	Spring cotter pin A2*	1473931		
6129-55-19	Combi screw 7976 5.5X19 washer 1.6 x 15 Vz FI*			
5500-117-61	Sheet nut St. 8.0 Mm Vz FI Pass	7129925749		

BMW, Mini clips & clamps

Item no.	Item description	Original No. 1	Original No. 2	Illustration
6464-10-10	Copper sealing ring 10.2 X 20.0 X 2.0	1.145.962		
5500-113-65	Sheet nut St. 4.8 Mm Vz FI Pass	N0154452		
5500-000-430	Cardboard clamp Vz FI	N0143893	N143893	
5500-113-62	Sheet nut St. 4.2 Mm Vz FI Pass	N0154292		
5500-114-04	Sheet nut St. 6.3 Mm Vz FI Pass	6031840	6738766	
5500-114-70	Sheet nut St. 4.8 Mm Vz FI Pass matt	N0154581		
5500-115-77	Sheet nut St. 5.5 Mm Vz FI Pass	7129925720		
5500-053-7	Sheet nut St. 4.8 Mm Vz FI Pass	1450293	207266	
5500-032-010	Sheet nut M6 Mkb 2.2 Si Gz	N90168602		
5500-114-27	Sheet nut St. 6.3 Mm Vz FI Pass	1470998		
5500-032-040	Sheet nut M8 Vz FI Pass	6103426		
6129-48-16	Combi screw 7976 4.8X16 washer 1.5 x 15 Vz FI*	7119916946	7119901294	
6129-48-19	Combi screw 7976 4.8X19 washer 1.5 x 15 Vz FI*	7119916949		
5500-523-14	Plastic expanding rivet Ø 5.0 - 5.5 Mm Pa 6 black	N10259301	1L0853934	
5501-105-041	Plastic expanding rivet for washer cover E34 Pom black	51711928946		

BMW, Mini clips & clamps

Item no.	Item description	Original No. 1	Original No. 2	Illustration
5501-529-80	Blind rivet plastic 5.8 X 19.0 Mm Pa / Pom black*	51717002953	51777171004	
5501-104-051	Plastic nut 5.0 Pa 6 black	A0039900251		
5500-411	Blind rivet plastic 5.0 X 12.0 Mm Pa 66 black			
5501-105-064	Plastic expanding rivet Ø 6.0 - 6.2 Mm Pa 66 black	N90359101		
5501-105-063	Plastic expanding rivet Ø 6.0 - 6.2 Mm Pa 66 black	51111944537		
5501-523-20	Plastic expanding rivet Ø 6.0 - 6.2 Mm Pa 66 black	51118174185		
5500-110-16	Plastic expanding rivet Ø 7.8 - 8.8 Mm Pa 66 black	N10583501		
5500-130-11	Plastic expanding rivet Ø 7.9 - 8.5 Mm Pa 66 black	16186729901C	N038549101C	
5500-201-404	Plastic expanding rivet Ø 8.0 - 8.2 Mm Pa 6 black	A2019900292	A2019900292/9051	
5501-107-102	Interior trim clip Ø 7.9 - 8.0 Mm Pom green	51411870718		
5501-107-103	Interior trim clip Ø 7.9 - 8.0 Mm Pom neutral	51411973500		
5501-105-601	Fir tree clip Ø 8.0 - 8.5 Mm Pe Ld black	N90201601		
6243-12-15	Locking screw M12 X 1.5 X 18 Sw 17 Vz*	11.131.273.093		
6242-12-15	Locking screw M14 X 1.5 X 20 Sw 13 Pho / Nbr*	11.137.513.050		
6366-1	Slotted nut 14441 M6 X 1 Sw 9 Vk 6My*	11.621.304.755		

BMW, Mini clips & clamps

Item no.	Item description	Original No. 1	Original No. 2	Illustration
6365-8	Flange nut self-tapping M8 Sw 12 Vk*	A1201420072		
5500-910-1	Expanding nut Pa 6 neutral	51135680113		
5500-115-22	Sheet nut St. 4.8 Mm Vz FI Pass			
5500-113-69	Sheet nut St. 6.5 Mm Vz FI Pass	803821117		
5500-116-67	Sheet nut St. 4.2 Mm Vz FI Pass	A0009942345		
5501-105-071	Sheet nut St. 4.8 Mm Mkb 3.0 Si	7129925715	7129904230	
5501-105-073	Sheet nut St. 4.8 Mm Mkb 2.1 Si	7129901656	7129925734	
5500-117-61	Sheet nut St. 8.0 Mm Vz FI Pass	7129925749		
5500-909-93	Cable tie 122 X 10.0 Mm Pa 66 black for T-bolts	N90091101		
5501-105-004	Cable tie 122 X 11.0 Mm with foot Pa 66 black	61131386642		
5500-299	Door frame clip Ø 3.5 Mm Pom white	51221817032		
5500-131-44	Plastic rivets without pin Ø 5.7 - 5.9 Mm Pom neutral	51471840960		
5501-104-001	Logo mounting	A0049883378		
5501-107-111	Grommet Pa 661 green	51711932996		
5501-105-014	Grommet Pa 66 neutral	51131934160		

BMW, Mini clips & clamps

Item no.	Item description	Original No. 1	Original No. 2	Illustration
5500-911-8	Interior trim clip Ø 9.0 - 9.5 Mm Abs black	435109		
5501-105-400	Interior trim clip Ø 7.9 - 8.0 Mm Pom neutral	51411885961		
5501-530-60	Interior trim clip Ø 7.9 - 8.0 Mm Pom yellow	51418172050		
5501-107-124	Interior trim clip Ø 8.3 - 8.5 Mm Pom yellow	7131503417		
5501-107-127	Interior trim clip Ø 8.2 Mm Pom blue	51139804996		
5501-105-005	Decorative trim clamp Pom yellow with green grommet Tpe	51138166675		
5501-530-50	Drive rivet Pa 66 black	51218205295		
6134-039-13	Collar screw 3.9 X 13 Vz3*	51.131.823.634		
5500-965	Washer clamp with adhesive strips	51311938494	51318177850	
5501-107-125	Quicky Ø 11.5 - 12.0 Mm MbK Si	51412756212		
5501-103-022	Washer nut M6 Vz	N910104006000		
5501-105-079	Washer nut M8 Vz blue Cr-3	51111835625	51117070183	
6366-2	Slotted nut 14441 M8 X 1.25 Sw 12 Vk 6My*	A0009903250		



Mercedes-Benz, Smart clips & clamps

Item no.	Item description	Original No. 1	Original No. 2	Illustration
5500-115-22	Sheet nut St. 4.8 Mm Vz FI Pass			
5500-937-7	Plastic expanding rivet Ø 8.0 - 8.2 Mm Pa 66 dark grey	N0385501		
5501-105-601	Fir tree clip Ø 8.0 - 8.5 Mm Pe Ld black	N90201601		
5501-107-105	Cover plug Ø 6.3 - 6.7 Mm Pa 66 black	A0009881128		
5500-117-51	Grommet Pa 6 red	A0009881581		
5500-112-89	Cable clamp 2 X Ø 4.0 Mm Vz FI Pass	A0009881778		
5501-060-90	Expanding nut St. 4.2 Mm Pa 661 neutral	441035555		
5500-124-28	Plastic expanding rivet Ø 5.0 - 5.2 Mm Pa 122 black*	A0009900392	A0009902292	
5500-130-11	Plastic expanding rivet Ø 7.9 - 8.5 Mm Pa 66 black	16186729901C	N038549101C	
6366-3	Slotted nut 14441 M10 X 1.5 Sw 14 Vk 6My*	A0009903150	N999901010000	
6366-2	Slotted nut 14441 M8 X 1.25 Sw 12 Vk 6My*	A0009903250		
5500-523-14	Plastic expanding rivet Ø 5.0 - 5.5 Mm Pa 6 black	N10259301	1L0853934	
5501-104-038	Plastic expanding rivet Ø 8.0 - 8.6 Mm Pa 12 black	N10032301		
5500-941-2	Drive rivet Ø 4.8 - 5.2 Mm Pa 66 black	A0009904092	A1249900592/9051	
5500-290-1	Square drive rivet 5.0 X 5.0 Mm Pa 66 black	A0009904492		

Mercedes-Benz, Smart clips & clamps

Item no.	Item description	Original No. 1	Original No. 2	Illustration
5501-107-104	Drive rivet Ø 6.2 Mm Pa 66 black	A0009904692		
5501-105-064	Plastic expanding rivet Ø 6.0 - 6.2 Mm Pa 66 black	N90359101		
5501-103-035	Plastic expanding rivet Ø 5.5 - 6.4 Mm Pa 661 black	N10219501	N10219502	
5501-104-404	Interior trim clip Ø 8.0 - 8.2 Mm Pom grey	A0009905792		
5501-447-50	Plastic expanding rivet Ø 8.0 Mm Pa 66 black	4D0807300B		
5501-107-109	Interior trim clip Ø 7.8 - 8.1 Mm Pom FI with gasket Sw	A0009910198		
5500-939-6	Fir tree clip Ø 7.0 - 7.2 Mm Pa 66 black	A0009912895		
5500-110-32	Drive rivet Ø 6.2 Mm Pa 6 / Pom black	7L6868307	8Z0857784	
5500-113-65	Sheet nut St. 4.8 Mm Vz FI Pass	N0154452		
5500-133-84	Sheet nut St. 4.8 Mm Vz FI Pass	A0009940645		
5500-114-04	Sheet nut St. 6.3 Mm Vz FI Pass	6031840	6738766	
5500-114-27	Sheet nut St. 6.3 Mm Vz FI Pass	1470998		
5500-114-70	Sheet nut St. 4.8 Mm Vz FI Pass matt	N0154581		
5500-116-67	Sheet nut St. 4.2 Mm Vz FI Pass	A0009942345		
5500-117-45	Sheet nut St. 4.2 Mm Vz FI Pass	A0009942545		

Mercedes-Benz, Smart clips & clamps

Item no.	Item description	Original No. 1	Original No. 2	Illustration
5500-113-46	Sheet nut St. 3.9 Mm Vz FI Pass	237929		
5500-113-69	Sheet nut St. 6.5 Mm z FI Pass	803821117		
5500-010-060	Door gasket clip Pa 665 neutral	704948		
5500-248-70	Interior trim clip upper section Pom white	A0019880981		
5500-248-60	Interior trim clip lower section Pom white	A0019881081		
5500-150-21	Grommet Pa 6 red	A0019882081		
5500-230-70	Decorative trim clamp Pa 620 black	A0019883081		
5500-237-60	Decorative trim clamp Pom 009 neutral	A0019883181		
5500-230-40	Decorative trim clamp Pom 130 neutral	A0019883281		
5501-104-031	Decorative trim clamp Pom neutral waxed	A0019884981		
5501-104-036	Grommet Pa 6 neutral	A0019887781		
5501-445-60	Percussion rivet Ø 7.4 - 7.6 Mm Pom / Ppe+Pa black	4D0807300		
5500-110-17	Plastic expanding rivet Ø 4.55 X 5.15 Mm Pom black	A0019901392		
5501-103-068	Plastic expanding rivet Ø 8.0 - 8.6 Mm Pa 661 black*	N10552001		
5500-110-15	Plastic expanding rivet Ø 4.0 - 4.2 Mm Pom 902 black	A0019902492		



Mercedes-Benz, Smart clips & clamps

Item no.	Item description	Original No. 1	Original No. 2	Illustration
5500-032-050	Sheet nut M8 self-tapping Vz FI Pass	6089805		
5501-402-50	Plastic expanding rivet Ø 7.0 - 7.2 Mm Pa 66 black	171885767		
5501-107-126	Sheet nut St. 4.2 Mm Mkb 2.1 Si	A0019946945		
5501-104-053	Prestole cage nut St. 4.8 Mm Mkb Si	A0019949845	90270271	
5501-104-048	Car jack mount Db Tpe / Pp Gf black	A0019979586		
5501-107-130	Plastic nut 5.0 Pa 66 Gf 30 black	WHT003207		
5500-032-000	Sheet nut M5 Mkb 2.2 Sw	E824115S74		
5500-032-060	Sheet nut St. 4.2 Mm Mkb 2.0 Ant			
5500-136-88	Interior trim clip Ø 7.5 - 7.7 Mm Pom neutral	A0039884178		
5501-447-70	Door frame clip Ø 4.0 Mm Pom white	171837199		
5501-104-051	Plastic nut 5.0 Pa 6 black	A0039900251		
5500-032-040	Sheet nut M8 Vz FI Pass	6103426		
5501-104-001	Logo mounting	A0049883378		
5501-104-046	Interior trim clip Ø 7.9 - 8.0 Mm Pom neutral	4D0867299A		
5500-405-0	Interior trim clip Ø 8.1 - 8.5 Mm Pom neutral	2E0867059		

Mercedes-Benz, Smart clips & clamps

Item no.	Item description	Original No. 1	Original No. 2	Illustration
5500-124-63	Cable tie 160 X 9.0 Mm with rivet Pa 12 black	A1149970290		
5500-124-65	Cable tie 120 X 9.0 Mm with rivet Pa 12 black	A1149970490		
6365-8	Flange nut self-tapping M8 Sw 12 Vk*	A1201420072		
5500-91-92	Plastic expanding rivet Ø 8.5 - 9.0 Mm Pa 6 dark grey	A1239900092		
6129-948-19	Combi screw 7976 4.8X19 washer 1.0 x 15 Vz Cr-3*	A1239900136		
5500-110-13	Plastic expanding rivet Ø 8.0 - 8.2 Mm Pa 6 black	A1239900292		
5500-69	Plastic nut M4 Pa 6 Gf 30 black	A1239901750		
5500-132-19	Sheet nut St. 4.8 Mm Vz FI Pass	A1239940645		
5501-107-106	Decorative trim clamp Pom neutral / metal Delta Seal Sw	A1249889478		
5500-248-40	Plastic expanding rivet Ø 6.0 - 6.1 Mm Pa 6 black	A1249900092		
5501-104-201	Decorative trim clamp Pa 66 black	A1249900792		
5500-113-62	Sheet nut St. 4.2 Mm Vz FI Pass	N0154292		
5500-201-404	Plastic expanding rivet Ø 8.0 - 8.2 Mm Pa 6 black	A2019900292	A2019900292/9051	
5501-104-054	Combi screw 7976 4.8X19 washer 2.0 x 26 Vzso*	A2019900536		

Mercedes-Benz, Smart clips & clamps

Item no.	Item description	Original No. 1	Original No. 2	Illustration
5500-606-14	Grommet Tpe-E neutral	A2019972281		
5501-107-134	Rain strip clamp Pom / Mkb Si	A2046900614		
5500-248-30	Plastic expanding rivet Ø 8.0 Mm Pa 66 grey	A2309900192		
5501-107-135	Cover plug Ø 8.2 Mm Pa 66 dark grey	A6389841661	A6389840061	
5501-103-022	Washer nut M6 Vz	N910104006000		
6129-65-20	Combi screw 7976 6.3X19 washer 1.6 x 18 Vz FI*	311821143		
6129-48-13	Combi screw 7976 4.8X13 washer 1.5 x 15 Vz FI*	N914032004214		

Clips Ford

Item no.	Item description	Original No. 1	Original No. 2	Illustration
5500-113-62	Sheet nut St. 4.2 Mm Vz FI Pass	N0154292		
5500-113-69	Sheet nut St. 6.5 Mm Vz FI Pass	803821117		
6129-65-20	Combi screw 7976 6.3X19 washer 1.6 x 18 Vz FI*	311821143		
5500-113-46	Sheet nut St. 3.9 Mm Vz FI Pass	237929		
5500-911-8	Interior trim clip Ø 9.0 - 9.5 Mm Abs black	435109		
5500-000-430	Cardboard clamp Vz FI	N0143893	N143893	
5500-010-060	Door gasket clip Pa 665 neutral	704948		
6464-16-24	Sealing ring metal / rubber 13.0 X 24.0 X 2.5 Vz*	1.005.578	6.157.668	
6464-128-225	Ford gasket 12.8 X 22.5 X 3.0 Nbr 70 black	1.005.593		
5501-337-30	Interior trim clip Ø 8.0 - 8.2 Mm Pom yellow	7M0867299K		
5501-103-035	Plastic expanding rivet Ø 5.5 - 6.4 Mm Pa 661 black	N10219501	N10219502	
6243-14-159	Locking screw M14 X 1.5 X 21 Sw 13 Pho*	1.013.938	97JM6730BA	
5500-337-20	Interior trim clip Ø 8.0 - 8.4 Mm Pom black / neutral	1020732		
5500-110-14	Removable plastic expanding rivet Pa 66 black	8E0825267		
5501-101-205	Interior trim clip Pom black with grommet Pe-Ld neutral	1H0837719		

Clips Ford

Item no.	Item description	Original No. 1	Original No. 2	Illustration
5501-105-601	Fir tree clip Ø 8.0 - 8.5 Mm Pe Ld black	N90201601		
5500-336-90	Fastening for pollen filter cover black / neutral	1106903	W703475S300	
5500-033-310	Sheet nut St. 4.2 Mm Vz FI Pass	1138971	W707715S309	
6464-10-10	Copper sealing ring 10.2 X 20.0 X 2.0	1.145.962		
5501-107-133	Interior trim clip Ø 6.0 Mm Pom neutral	1208973		
5500-336-80	Interior trim clip Pom black	1257376		
5501-701-00	Expanding nut Pa 66 neutral	1416795		
5500-030-270	Cover plug Ø 7.2 Mm Pom black	1443038		
6365-61	Flange nut M8 Sw 13 H 8 self-tapping Vk*	1448187		
5500-053-7	Sheet nut St. 4.8 Mm Vz FI Pass	1450293	207266	
5500-156-1	Sheet nut St. 4.2 Mm Vz FI Pass	211837223	N0154301	
6243-14-15	Locking screw M14 X 1.5 X 16 Sw 13 blank oiled	1.454.117	6.732.529	
6243-14-161	Locking screw M14 X 1.5 X 22 Sw 19 Zn Ni*	N90813201	N90813202	
6395-12-151	Wheel nut M12 x 1.5 Sw 19 Vz*	1.470.843		
5500-114-27	Sheet nut St. 6.3 Mm Vz FI Pass	1470998		







Clips Ford

Item no.	Item description	Original No. 1	Original No. 2	Illustration
5500-307-71	Spring cotter pin A2*	1473931		
5500-121-9	Sheet nut St. 3.5 Mm Vz FI Pass	1474663		
5500-030-540	Cover plug Ø 8.2 - 8.4 Mm Pa 66 black	1480335		
5501-301-70	Fir tree clip Ø 6.0 Mm Pa 66 black	82386320301C		
5501-107-131	Interior trim clip Ø 6.0 Mm Pom neutral	1552662	W709010S300	
5501-107-130	Plastic nut 5.0 Pa 66 Gf 30 black	WHT003207		
5500-940-5	Fir tree clip Ø 7.0 - 7.4 Mm Pa 66 black	1629082		
5500-145-45	Cover plug Ø 8.40 X 8.62 Mm Pom black	1629279	6725950	
5500-033-590	Expanding nut St. 4.8 Mm Pa 6 white	1659672		
5500-053-6	Sheet nut St. 4.2 Mm Vz FI Pass	1716235		
5501-107-132	Fir tree clip Ø 7.2 Mm Pa 66 black	4740548	W709571S300	
6243-12-160	Locking screw M12 X 1.75 X 25 Sw 15 Vz*	4.948.795	9L8E6730AA	
5500-114-04	Sheet nut St. 6.3 Mm Vz FI Pass	6031840	6738766	
5500-031-190	Fir tree quick fastener Pom black	6049625		
5500-137-361	Cover plug Ø 7.0 Mm Pho Imp	6071353		

Clips Ford

Item no.	Item description	Original No. 1	Original No. 2	Illustration
5500-032-050	Sheet nut M8 self-tapping Vz FI Pass	6089805		
5500-032-040	Sheet nut M8 Vz FI Pass	6103426		
5500-033-340	Square drive rivet 7.1 X 11.0 Mm Pa 66 black	6114021		
5500-405-0	Interior trim clip Ø 8.1 - 8.5 Mm Pom neutral	2E0867059		
5500-130-11	Plastic expanding rivet Ø 7.9 - 8.5 Mm Pa 66 black	16186729901C	N038549101C	
5500-110-6	Cover plug for 5.0 threaded bolts Pp black	6142789		
5500-337-40	Expanding nut St. 4.8 Mm Pa 66 neutral	N90786701		
5501-107-128	Expanding nut St. 4.2 Mm Pa 66 neutral	701864445B		
5500-033-570	Interior trim clip Ø 8.0 - 8.4 Mm Pom neutral	6176723	6117693	
5501-107-129	Fir tree clip Ø 8.0 X 8.2 Mm Pom black	6560532	W700185S300	
5500-033-560	Expanding nut St. 4.2 Mm Pa 6 red	6695013		
6134-048-16	Collar screw 4.8 X 16 Vz3*	6.707.417	W700426S303	2 
5500-000-000	Quicky for T-bolts Ø 5.0 Mm Geo Plus	N90335004	N90335006	
5500-937-7	Plastic expanding rivet Ø 8.0 - 8.2 Mm Pa 66 dark grey	N0385501		
5501-447-10	Interior trim clip Ø 7.8 - 8.0 Mm Pa 66 black	703867299		



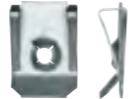











Clips Ford



Item no.	Item description	Original No. 1	Original No. 2	Illustration
5500-008-300	Blind rivet 4.0 X 8.0 alu / steel black			
5500-411	Blind rivet plastic 5.0 X 12.0 Mm Pa 66 black			
5500-032-060	Sheet nut St. 4.2 Mm Mkb 2.0 Ant			
5500-001-191	Cable clamp Ø 17.0 Mm Pa 6 neutral			
6464-14-22	Sealing ring 14.5 X 22.0 X 2.0 Pa 66 natural	145118 weiss		
5500-032-000	Sheet nut M5 Mkb 2.2 Sw	E824115S74		
5500-032-290	Sheet nut St. 4.8 Mm self-tapping Mkb 2.0 Si	E824123S71		

Audi, Seat, Skoda, VW clips & clamps

Item no.	Item description	Original No. 1	Original No. 2	Illustration
5501-123-301	Decorative trim clamp neutral with red ring	113853585C		
5501-107-123	Decorative trim clip Pom neutral	3C0853585		
5501-457-90	Screw cap mount Pom black	4A0805163		
5501-458-00	Screw cap mount Si	4A0805960		
5501-461-40	Screw cap mount Si	8D0805960		
5501-107-122	Plastic expanding rivet Ø 12.0 - 12.2 Mm Pa 66 black	6J0821213		
5501-445-90	Plastic expanding rivet Ø 8.0 Mm Pom 550 black	8L0807300		
5500-113-65	Sheet nut St. 4.8 Mm Vz FI Pass	N0154452		
5500-000-430	Cardboard clamp Vz FI	N0143893	N143893	
5500-113-62	Sheet nut St. 4.2 Mm Vz FI Pass	N0154292		
5500-032-010	Sheet nut M6 Mkb 2.2 Si Gz	N90168602		
5500-156-1	Sheet nut St. 4.2 Mm Vz FI Pass	211837223	N0154301	
5501-001-90	Sheet nut St. 6.3 Mm Vz FI Pass	N0154322		
5501-105-080	Sheet screw 4.8 x 16 with pressured washer Vzs Cr-3*	N90775001		
5500-201-341	Cable tie 210 X 4.8 Mm with foot Ø 6.5 Mm black	N90666101		

Audi, Seat, Skoda, VW clips & clamps

Item no.	Item description	Original No. 1	Original No. 2	Illustration
5500-523-14	Plastic expanding rivet Ø 5.0 - 5.5 Mm Pa 6 black	N10259301	1L0853934	
5501-103-035	Plastic expanding rivet Ø 5.5 - 6.4 Mm Pa 661 black	N10219501	N10219502	
5500-110-34	Drive rivet Ø 6.2 Mm Pa 6 / Pom black	8N8868307		
5500-110-32	Drive rivet Ø 6.2 Mm Pa 6 / Pom black	7L6868307	8Z0857784	
5500-127-10	Plastic expanding rivet Ø 5.9 - 7.1 Mm Pa 6 black	N0385012		
5500-000-000	Quicky for T-bolts Ø 5.0 Mm Geo Plus	N90335004	N90335006	
5501-107-101	Clamping washer for T-bolts Ø 5.0 mm Geomet 321 silver	N90796501		β 
6129-65-20	Combi screw 7976 6.3X19 washer 1.6 x 18 Vz FI*	311821143		
5501-457-60	Screw cap Pa black	4A0805121A		
5501-457-80	Screw cap Pa black	4A0805121C		
5501-105-064	Plastic expanding rivet Ø 6.0 - 6.2 Mm Pa 66 black	N90359101		
5501-659-50	Quick-lock screw 7.0 X 18.0 Delta Protekt	8D0805121		
5500-110-16	Plastic expanding rivet Ø 7.8 - 8.8 Mm Pa 66 black	N10583501		
5500-130-11	Plastic expanding rivet Ø 7.9 - 8.5 Mm Pa 66 black	16186729901C	N038549101C	
5501-402-50	Plastic expanding rivet Ø 7.0 - 7.2 Mm Pa 66 black	171885767		











Item no.	Item description	Original No. 1	Original No. 2	Illustration
5501-461-30	Screw fastener metal 7.0 x 21.0 black	8D0805121B		
5501-447-50	Plastic expanding rivet Ø 8.0 Mm Pa 66 black	4D0807300B		
5500-145-84	Plastic expanding rivet Ø 8.0 - 8.2 Mm Pa 12 black	N90229301		
5501-104-038	Plastic expanding rivet Ø 8.0 - 8.6 Mm Pa 12 black	N10032301		
5501-103-068	Plastic expanding rivet Ø 8.0 - 8.6 Mm Pa 661 black*	N10552001		
5500-110-14	Removable plastic expanding rivet Pa 66 black	8E0825267		
5500-117-75	Grommet E / Ba black	113857219A		
5501-464-20	Interior trim clip Ø 10.0 X 10.2 Mm Pom black	8E0868243		
5501-107-121	Door gasket clip Pa 66 yellow	1Z0837732A		
5500-147-20	Door gasket clip Pa 665 black	251823717		
5501-101-205	Interior trim clip Pom black with grommet Pe-Ld neutral	1H0837719		
5501-101-226	Interior trim clamp Pom 309 neutral	701853585		
5501-442-50	Fir tree clip Pa 66 black	1H0819055B01C		
5501-301-70	Fir tree clip Ø 6.0 Mm Pa 66 black	82386320301C		
5501-447-10	Interior trim clip Ø 7.8 - 8.0 Mm Pa 66 black	703867299		

Audi, Seat, Skoda, VW clips & clamps

Item no.	Item description	Original No. 1	Original No. 2	Illustration
5500-129-54	Interior trim clip Ø 7.8 - 8.0 Mm Pa 66 black	823867299		
5500-917-0	Cover plug Ø 7.8 X 8.0 Mm Pom black	80186729901C	801867299041	
5501-424-90	Interior trim clip Ø 7.9 Mm Pa 66 neutral	171867299B		
5501-104-046	Interior trim clip Ø 7.9 - 8.0 Mm Pom neutral	4D0867299A		
5501-464-00	Interior trim clip Pom / Pa 66 black	6Q0868243		
5500-405-0	Interior trim clip Ø 8.1 - 8.5 Mm Pom neutral	2E0867059		
5501-101-201	Interior trim clip Ø 8.0 - 8.2 Mm Pa 66 neutral	171807249A		
5501-445-30	Interior trim clip Ø 8.0 - 8.2 Mm Pom neutral	6X0867300A		
5501-337-30	Interior trim clip Ø 8.0 - 8.2 Mm Pom yellow	7M0867299K		
5501-105-601	Fir tree clip Ø 8.0 - 8.5 Mm Pe Ld black	N90201601		
5500-110-25	Interior trim clip Pom neutral	8E9867299		
6243-14-161	Locking screw M14 X 1.5 X 22 Sw 19 Zn Ni*	N90813201	N90813202	
5501-449-60	Expanding nut Pa 66 black*	N90833801		
5501-060-90	Expanding nut St. 4.2 Mm Pa 661 neutral	441035555		
5500-337-40	Expanding nut St. 4.8 Mm Pa 66 neutral	N90786701		

Item no.	Item description	Original No. 1	Original No. 2	Illustration
5500-879-32	Expanding nut St. 4.8 Mm Pa 6 Gf 30 black	867809966		
5501-107-114	Expanding nut St. 4.8 Mm Pa 6 neutral with rubber lip black	N10516801		
5500-897-33	Expanding nut St. 4.8 Mm Pa 6 Gf 30 black	811807577F		
5501-101-001	Expanding nut St. 4.8 Mm Pa 6 Gf 30 black	811807577C		
5501-101-229	Expanding nut St. 4.8 Mm Pa 6 black	357827998		
5501-101-230	Expanding nut St. 4.8 Mm Pa 6 grey	357868143		
5501-447-30	Cover plug Ø 7.9 - 8.1 Mm Pe black	N90533301		
5501-432-70	Blind rivet 4.0 X 14.0 alu / steel black	N90634901		
5501-000-90	Sheet nut St. 4.2 Mm half Vz FI Pass	N0154832		
5500-115-22	Sheet nut St. 4.8 Mm Vz FI Pass			
5501-001-30	Sheet nut St. 4.8 Mm Vz FI Pass			
5500-113-69	Sheet nut St. 6.5 Mm Vz FI Pass	803821117		
5501-055-10	Sheet nut St. 4.8 Mm stainless steel (1.4301)	N10194101		
5501-067-90	Sheet nut St. M4 self-tapping Mkb 2.0 Si	N90419002		
5501-137-04	Sheet nut St. 3.9 Mm Vz FI Pass	N90074301		







Audi, Seat, Skoda, VW clips & clamps

Item no.	Item description	Original No. 1	Original No. 2	Illustration
5501-441-00	Sheet nut St. 6.3 Mm Mkb 2.2 Si Gz	N0154491	N0154492	
5500-909-93	Cable tie 122 X 10.0 Mm Pa 66 black for T-bolts	N90091101		
5500-238-3	Cable tie 140 X 4.5 Mm with foot Pa 66 black	N90205501		
5501-447-70	Door frame clip Ø 4.0 Mm Pom white	171837199		
5501-107-130	Plastic nut 5.0 Pa 66 Gf 30 black	WHT003207		
5500-937-7	Plastic expanding rivet Ø 8.0 - 8.2 Mm Pa 66 dark grey	N0385501		
5501-107-108	Plastic expanding rivet Pa 66 black	8L3837199B		
5501-689-40	Revolving pipe and cable holder Pa 66 black	N10446801		
5501-107-128	Expanding nut St. 4.2 Mm Pa 66 neutral	701864445B		
5501-420-90	Expanding nut Pa neutral*	431805445		
5501-101-228	Expanding nut St. 4.2 Mm Pa 66 beige	165827592		
5501-449-30	Expanding nut St. 5.5 Mm Pa 66 black	441807300B		
5501-107-119	Clamp Pho Imp	1J9867981		
5501-440-50	Grommet Tpv green	1H0853586		
5501-444-70	Grommet Tpe-E 55 black	357853586D	191853586	

Audi, Seat, Skoda, VW clips & clamps

Item no.	Item description	Original No. 1	Original No. 2	Illustration
5501-101-105	Interior trim clip Pom black	3B0868243		
5501-101-211	Interior trim clip Ø 8.0 Mm Pom / Pa 66 - brown / neutral	1H0868243B	1H0868243	
5501-101-212	Interior trim clip Pom black	1H0868244B		
5501-446-90	Interior trim clip Ø 8.0 - 8.2 Mm Pom neutral	6X0868243A		
5501-464-40	Interior trim clip Pom black with seal*	5X0867299		
5501-117-74	Decorative trim clamp zinc-plated*	113853585B		
5500-400-2	Decorative trim clip Pom neutral	171853585A		
5501-101-206	Decorative trim clamp neutral Golf Iii (short)	1H0853585		
5501-101-003	Roof decorative trim clamp Pom neutral	191853733A	6U0853733	
5501-101-207	Decorative trim clip Pom neutral	1H0853585A		
5501-448-40	Decorative trim clamp neutral with green grommet	3A0853575		
5501-101-208	Decorative trim clip Pom neutral	1H0853733B		
5501-107-120	Decorative trim clip Pom neutral	8R0853909A		
6395-112-15	Wheel bolt M12 X 1.5 x 22.5 Mm Sw 17 Vz FI*	3A0601139	-	
6395-214-15	Wheel bolt M14 X 1.5 x 25.5 Mm Sw 17 Vz FI*	8D0601139D	WHT002437	

Audi, Seat, Skoda, VW clips & clamps

Item no.	Item description	Original No. 1	Original No. 2	Illustration
5501-400-80	Sealing nut M4 Sw 11 black	171853939		
5501-063-10	Self-tapping nut M4 Vz FI Pass	N0386021		
5501-101-237	Square drive rivet 8.5 X 8.5 Mm with cap Pa 6 black	1H0819055C01C		
5501-400-70	Door gasket clip Pa 6 white	133823717		
5501-448-60	Door gasket clip Pa 66 grey	3B0839723		
5501-445-60	Percussion rivet Ø 7.4 - 7.6 Mm Pom / Ppe+Pa black	4D0807300		
5501-010-2	Weldable nut M8 blank	N0114071		
5500-114-70	Sheet nut St. 4.8 Mm Vz FI Pass matt	N0154581		
5501-143-00	Plastic expanding rivet Ø 3.5 X 3.7 Mm Pom black	113857117B		

01

Upholstery clamp pliers

- ▶ Item no. 8714-02-10

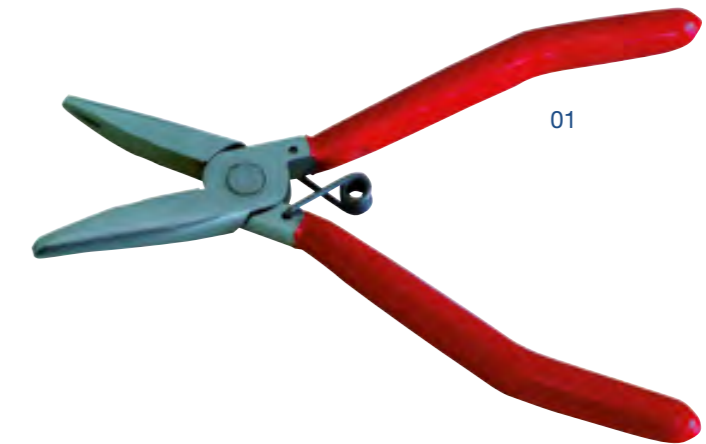

01

Cushion clamp

- ▶ Item no. 5500-500-08



B 2 / H 20,2

02

Clip releaser tool

2-pc. set

- ▶ Item no. 8715-57-700

- ▶ Product description
- Installation wedge dimensions:
20.5 x 265 mm
- Dimensions of decorative trim wedge:
30 x 200 mm



02

03

Dismounting lever

for clips

- ▶ Item no. 8715-57-701

- ▶ Product description
- Extra-slender design
- Made from metal
- With rubber coating to prevent
paintwork damage
- Length 165 mm
- Fork opening 5 mm



03

Car glazing





01
Windscreen adhesive
Screenox Quantum

- ▶ Item no. 2893-506-10
- ▶ Contents: 300 ml
- ▶ Packing unit: 12

▶ **Product description**

- Single-component PUR windscreen adhesive
- Compatible with MS polymers and thus workable on cut-back residual MS adhesive bead
- Very easy ejection
- No activator needed
- 60 min. for double airbag in temperature range of -10°C to +35°C
- Processing time: 15 minutes
- Cures down to -10°C
- Very good stability
- Meets OEM/automotive manufacturer requirements
- Very short thread breaks
- Very strong
- Suitable for aerials
- Can be processed cold
- Non-conducting
- Solvent-free

02
Windscreen adhesive
Screenox Quantum

- ▶ Item no. 2893-506-30
- ▶ Contents: 400 ml
- ▶ Packing unit: 12



03
Windscreen adhesive set: Cartridge

- ▶ Item no. 2893-506-20
- ▶ Contents: 5 pieces
- ▶ Packing unit: 24

- ▶ **Set contents:**
- 1 x Screenox Quantum windscreen adhesive, 300 ml cartridge
 - 1 x 3 in 1 multiprimer in 5 ml snap ampoule
 - 1 x primer brush
 - 1 x cartridge point
 - 1 x instructions

04
Windscreen adhesive set: Bag

- ▶ Item no. 2893-506-40
- ▶ Contents: 5 pieces
- ▶ Packing unit: 24

- ▶ **Set contents:**
- 1 x Screenox Quantum windscreen adhesive, 400 ml bag
 - 1 x 3in1 multiprimer in ml snap ampoule
 - 1 x Primer brush
 - 1 x Cartridge point
 - 1 x Instructions



01 + 03



02 + 04





01
Windscreen adhesive
Screenox Cold - New Generation

- ▶ Item no. 2893-504-10
- ▶ Contents: 300 ml
- ▶ Packing unit: 12

▶ **Product description**

- Drive-away time: without airbag 60 minutes, with twin airbag 2 hours
- Temperature range: -10°C to +30°C
- Pot life: 15 minutes
- High modulus
- Suitable for aerials
- Short cut-off string
- Stability meets the requirements of OEMs (vehicle manufacturers)
- Incl. tips

02
Windscreen adhesive package
Screenox Cold - New Generation

- ▶ Item no. 2893-504-30
- ▶ Contents: 400 ml
- ▶ Packing unit: 12



03
Windscreen adhesive set
Cartridge

- ▶ Item no. 2893-504-20
- ▶ Contents: 7 pieces
- ▶ Packing unit: 24

▶ **Set contents:**

- 1 x 300 ml cartridge of Screenox Cold - New Generation windscreen adhesive
- 1 x 3in1 multiprimer in 5 ml snap ampoule
- 1 x Primer brush
- 1 x Cartridge point
- 1 x Instructions



04
Windscreen adhesive set
Bag

- ▶ Item no. 2893-504-40
- ▶ Contents: 7 pieces
- ▶ Packing unit: 24

▶ **Set contents:**

- 1 x 400 ml bag of Screenox Cold - New Generation windscreen adhesive
- 1 x 3in1 multiprimer 30 ml
- 1 x Primer brush
- 1 x Bag adapter
- 1 x Instructions



IDEAL FOR USE ON COMMERCIAL VEHICLES!





01
3 in 1 combi primer
Colour: black

- ▶ Item no. 2893-580-30
- ▶ Contents: 30 ml
- ▶ Packing unit: 24

- ▶ Item no. 2893-580-100
- ▶ Contents: 100 ml
- ▶ Packing unit: 8

- ▶ **Product description**
- Adhesion promoter, rust protection, black primer (UV protection) and corrosion protection in one
- Quick to use and increased safety with just one pre-treatment product
- can be used on ceramic screen print, glass and bright metal



02
Brush
For primer, made from cotton

- ▶ Item no. 2893-540

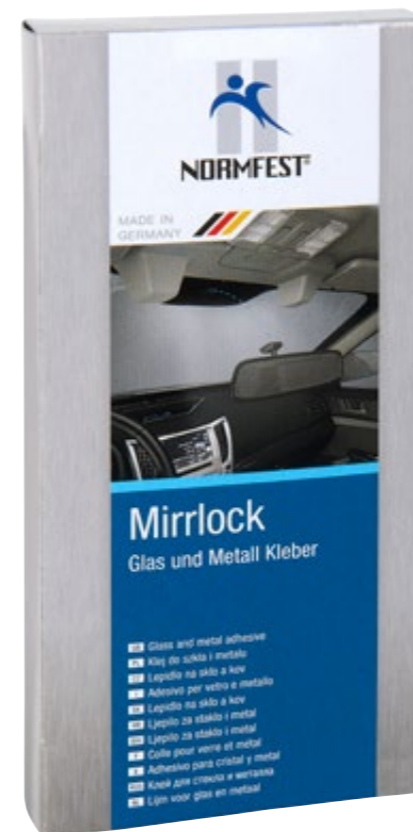

04
Glass Metal Adhesive
Mirrlock

- ▶ Item no. 2898-557

- ▶ **Product description**
- 2-component adhesive
- Temperature range: -55°C to +120°C
- Touch dry after approx. 20 seconds
- Curing: approx. 12 hours at 23°C and 55% air humidity
- Tensile strength: approx. 35 N/mm² (glass breaks)

- Note: Not suitable for Ford vehicles!

03
Washer sealant
Screenfit

- ▶ Item no. 2893-220
- ▶ Contents: 310 ml
- ▶ Packing unit: 12

Black



- ▶ **Product description**
- Can be dabbed
- Resistant to water, road salt and weathering
- After curing, thermally stable from -30°C to +80°C



04



01
Active cleaning cloths
Jumbo pail

- ▶ Item no. 2897-260-70
 - ▶ Contents: 75 wipes
 - ▶ Packing unit: 1
-
- ▶ **Product description**
- Lemon-scented
 - Lint-free
 - Dermatologically tested
 - Cleaning cloths easily remove even bodywork, plastic and windscreen adhesive residue



01



CLEAN!!!

02
Intensive window cleaner
Topas

- ▶ Item no. 2897-310
 - ▶ Contents: 400 ml
 - ▶ Packing unit: 24
-
- ▶ Item no. 2000-03
 - ▶ Contents: 5 litres
 - ▶ Packing unit: 1
-
- ▶ **Product description**
- Silicone-free
 - Also suitable for polycarbonate glass
 - Safe for surfaces
 - Foam formation only after the surface has been coated with the product

03
Glass cleaner
Stries Protect

- ▶ Item no. 2897-340
 - ▶ Contents: 500 ml
 - ▶ Packing unit: 12
-
- ▶ Item no. 2897-340-5
 - ▶ Contents: 5 litres
 - ▶ Packing unit: 1
-
- ▶ **Product description**
- Removes dirt, marks, fingerprints, grease, nicotine, dead insects, etc.
 - Free of silicone and ammonia
 - Can be used on glass, polycarbonate glass



04

04
Spout for 5 litre containers

- ▶ Item no. 2000-000-005

Spout for 30 litre containers

- ▶ Item no. 2000-000-030



02



03



01

Screenout Easy

Screen cutting-out system

► Item no. 2893-699-999

► 11 pieces

► Product description

- Contents:
- 1 x Cutting-out device (angled & with flexible rollers for the cord)
- 1 x Vacuum pump
- 2 x Cutting-out cord (tensile force approx. 210 daN)
- 1 x Piercing awl (art. no. 8715-57-68)
- 1 x Cutting blade (art. no. 8715-57-600)
- 1 x Decorative trim wedge (art. no. 8715-57-700)
- 1 x Pick
- 1 x Angular gear
- 1 x Replacement shaft
- 1 x Flexible shaft
- 1 x Threading tool
- 1 x Adapter for bit inserts
- 2 x Cut-out protector
- 1 x Instructions for use
- 1 x Plastic case



01

02

Car glazing system

Screenout

► Item no. 2893-999-999

► 23 pieces Product description

- Contents:

- 1 x puller (art. no. 8715-57-71)
- 1 x duct tape (art. no. 4992-380)
- 2 x vacuum lifting tools (art. no. 8715-57-61)
- 2 x pull handles (art. no. 8715-57-65)
- 1 x awls (art. no. 8715-57-68)
- 1 x handle (art. no. 8715-57-694)
- 10 x blades, 16 mm (art. no. 8715-57-692)
- 1 x cutting wire (art. no. 8715-57-63)
- 1 x installation and decorative strip wedge (art. no. 8715-57-700)
- 1 x vacuum gel (art. no. 2600-15)
- 1 x cutter blade (art. no. 8715-57-600)
- 1 x storage box (art. no. 1962-1-4)



02

01

Gaffer tape

- ▶ Item no. 4992-360
- ▶ Colour: silver

- ▶ Item no. 4992-370
- ▶ Colour: black

- ▶ Technical specifications
- Width: 50 mm
- Length: 50 m
- reinforced



01

02

Safety knife

Martor quality

- ▶ Item no. 8715-57-604

- ▶ Item no. 8715-57-605
- ▶ Spare blades 10 pieces.



02

03

Cutter knife

Incl. one spare blade

- ▶ Item no. 8715-57-600

- ▶ Item no. 8715-57-601
- ▶ Spare blades 10 pieces.



03

04

Round nozzle

For aluminium cartridge, embossed, length: 8.2 cm

- ▶ Item no. 2891-02-25



04

05

Triangular nozzle

for windscreen adhesive

- ▶ Item no. 2891-02-30



05

06

Cartridge opener

- ▶ Item no. 2891-02-50



06

07

Bag adaptor and nozzle set

for 400 ml bags

- ▶ Item no. 2893-560

- ▶ Product description
- 1 x bag adaptor
- 2 x round nozzle (2891-02-25)



07



08

Windscreen cutter

- ▶ Item no. 8697-5

- ▶ Product description
- Rated input: 400 W
- Output: 220 W
- Oscillations: 11,000-18,500 1/min
- Cable with plug: 5 m
- Weight: 1.25 kg
- For windscreen specialists, car and truck workshops
- Fast, safe and easy-to-handle system
- Powerful 400 W motor for high cutting speeds
- Stepless electronic cutting frequency
- Hex tool holder with friction-locked connection between the machine and tool
- Supplied package:
- 1 x Windscreen cutter Super Cut FSC
- 1 x Plastic tool case 1 x whetstone (art no.:8697-5-1)
- 1 x Spanner wrench (art no.: 8697-600)
- 1 x Clamp screw

09

Round saw blades

- ▶ Product description
- For further use of the special cutter when sawing sheet metal and GRP as well as cutting scrap bridges (bodywork saw)

Item no.	Ø mm	Sales unit
8697-580-2	63	1
8697-581-2	80	1



09

Spare grindstone

- ▶ Item no. 8697-5-1



08



01

Suction cup handle
double-jointed

▶ Item no. 8715-57-61

▶ Product description

- With double joint
- Max. lift: 30 kg
- Suction cups: diameter 150 mm, with suck-on mechanism
- Safety lock
- High-grade ABS plastic, acid and oil resistant
- Ideal for curved glass
- Flexible

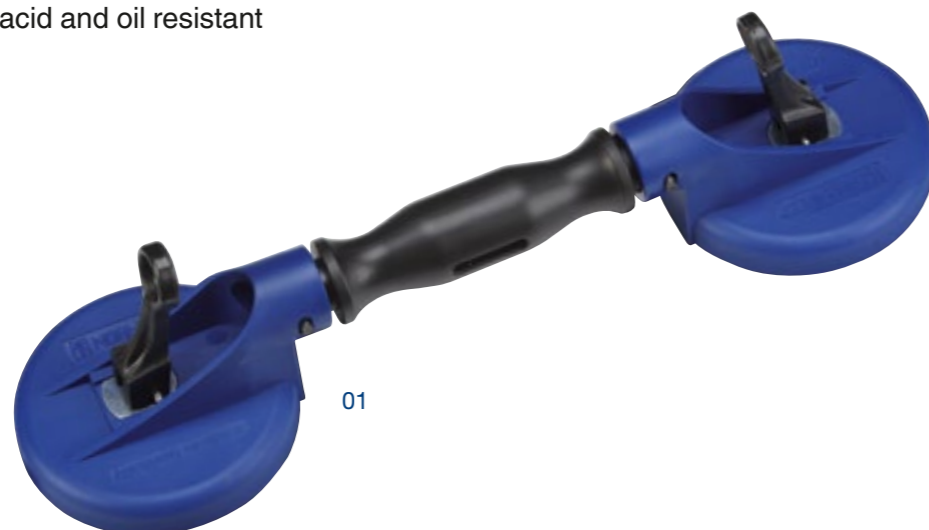

01

02

Fixing lifting tool

- ▶ Item no. 8715-57-69
- ▶ 1 packing unit = 6 pcs.

▶ Product description

- Suitable for fixing glued trim strips and windscreen frames



02

03

Clip releaser tool

2-pc. set

▶ Item no. 8715-57-700

▶ Product description

- Installation wedge dimensions: 20.5 x 265 mm
- Dimensions of decorative trim wedge: 30 x 200 mm



03

04

Pump vacuum lifting tool

Tested by TÜV North

▶ Item no. 8715-57-610

▶ Technical specifications

- With its supporting force of 120 kg, it can especially be used in the truck and utility vehicles sector
- Non-slip rubber coating
- With safety marking
- Safety tested by TÜV Nord



04

05

Windscreen stand

Also suitable for HGVs and vans

▶ Item no. 7714-200

▶ Product description

- Also suitable for HGVs and vans
- Non-slip due to special foam rubber padding
- Max. load capacity 120 kg
- Foldable



05

01

Cutting wire

Ideal for high modulus windscreen adhesive

- ▶ Item no. 8715-57-63
- ▶ Square profile, 50 m



01

02

Piano cutting wire

for sawing

- ▶ Item no. 8715-57-64
- ▶ drilled, 20 m



02

03

Traction handle

for windscreen removal wire

- ▶ Item no. 8715-57-65



03

08

Screen cutting-out cord

- ▶ Item no. 2600-20

- ▶ Product description

- 210 dN tensile force => much more resilient
- Oval shape => cut with less force required
- 65 m on one roll
- Colour: blue



08

04

Counter bracket

for windscreen removal wire

- ▶ Item no. 8715-57-67



04

05

Insert awls

for windscreen removal wire

- ▶ Item no. 8715-57-66



05

09

Cold knife

Ideal for side and rear windows

- ▶ Item no. 8697-603
- ▶ Knife, incl. 25 mm blade
- ▶ Item no. 8697-604
- ▶ Spare blade, 18 mm
- ▶ Item no. 8697-605
- ▶ Spare blade, 25 mm



09

06

Insert awls (sword)

for windscreen removal wire

- ▶ Item no. 8715-57-68



06

07

Window scraper

- ▶ Item no. 8715-64-700

Spare blades

- ▶ Item no. 8715-64-71
- ▶ Spare blades, 10 pcs.



07

10

PU scraper set

ideal for the cutting back of the remaining adhesive bead

- ▶ Item no. 8715-57-690

- ▶ Product description

Contents:

- 10 x 12 mm spare blade (art. no. 8715-57-691)
- 10 x 16 mm spare blade (art. no. 8715-57-692)
- 10 x 20 mm spare blade (art. no. 8715-57-693)
- 1 x Handle for PU scraper (art. no. 8715-57-694)



10

01
Window removal knife
Packing unit, 2 pieces

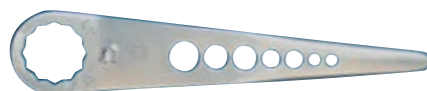

Item no.	Model
8697-002-099	16.0 mm
8697-002-123	32.0 mm
8697-002-168	45.0 mm
8697-002-160	54.0 mm
8697-002-097	58.0 mm
8697-002-081	60.0 mm
8697-002-125	70.0 mm
8697-002-171	70.0 mm
8697-002-194	110.0 mm

02
Window removal knife
Packing unit, 2 pieces



Item no.	Model
8697-004-152	39.0 mm
8697-003-072	45.0 mm
8697-003-143	16.0 – 35.0 mm
8697-004-195	32.0 – 46.0 mm
8697-004-182	42.0 – 60.0 mm
8697-004-169	60.0 – 76.0 mm

05
Windscreen cutter blade, toothed
Packing unit, 2 pieces



Item no.	Model
8697-009-208	19.0 mm
8697-009-207	25.4 mm
8697-009-209	38.0 mm

06
Window removal knife
Packing unit, 2 pieces



Item no.	Model
8697-006-120	14.0 mm
8697-006-103	35.0 mm

03
Window removal knife
Packing unit, 2 pieces



Item no.	Model
8697-005-083	10.0 mm
8697-005-108	16.0 mm
8697-005-118	19.5 mm
8697-005-115	22.0 mm
8697-005-076	24.0 mm
8697-005-163	28.0 mm
8697-005-114	32.0 mm
8697-005-147	32.0 mm
8697-005-191	32.0 mm
8697-005-079	36.0 mm
8697-005-110	40.0 mm
8697-005-156	40.0 mm
8697-005-154	45.0 mm
8697-005-155	60.0 mm
8697-005-157	60.0 mm
8697-005-101	60.0 mm
8697-005-107	60.0 mm

04
Window removal knife
Packing unit, 2 pieces



Item no.	Model
8697-001-121	26.0 mm
8697-001-073	35.0 mm
8697-001-176	90.0 mm

07
Blade for removing residual adhesive beads
Packing unit, 2 pieces



Item no.	Model
8697-007-129	12.0 mm
8697-007-146	18.0 mm

08
Blade for removing residual adhesive beads
Packing unit, 2 pieces



Item no.	Model
8697-007-113	25.0 mm

09
Windscreen cutter blade, toothed
Packing unit, 2 pieces



Item no.	Model
8697-005-211	25.5 mm
8697-005-212	38.0 mm

01

Window Repair Kit

Screen repair

► Item no. 2600-999-999

Item no.	Description
2600-01	10 x cutting blade
2600-04	1 x 12 V electric drill
2600-06	1 x jointed inspection mirror with suction pad
2600-07	2 x glass drill bit 1.2 mm
2600-08	1 x hardening film
2600-09	1 x lapping polisher
2600-10	1 x polish
2600-11	1 x repair resin
2600-12	1 x finish resin
2600-15	1 x vacuum gel
2600-16	1 x tool holder with spring capsule
2600-045	1 x 230 V transformer
3721-503	1 x LED inspection lamp
2600-14	1 x spare lamp



01

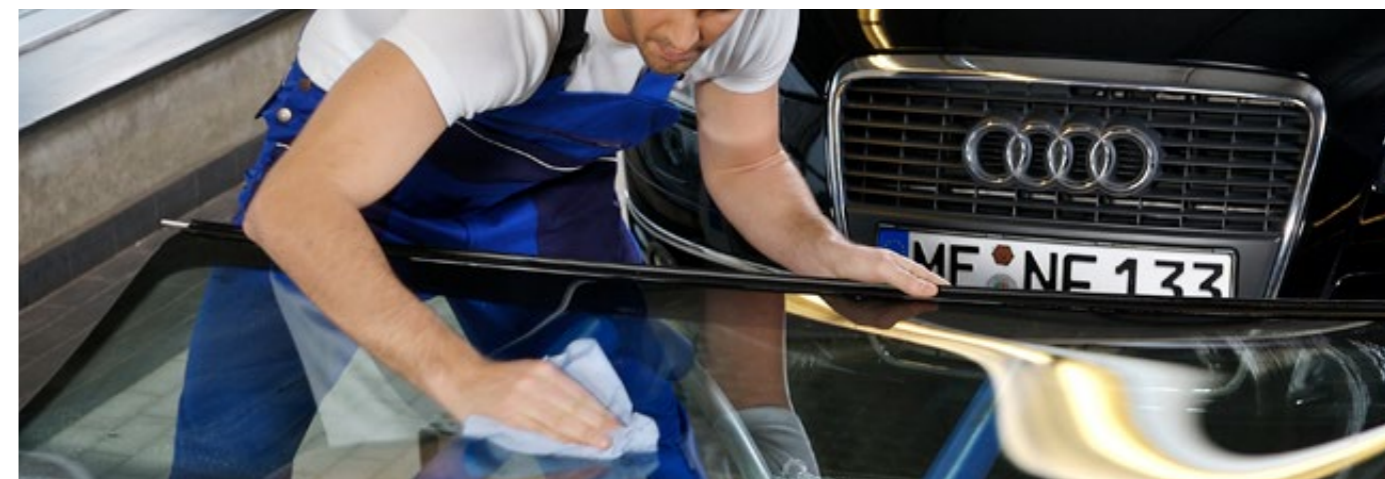

02

Hand drill

For the screen repair kit Screenrepair

► Item no. 2600-21

► Technical specifications

- Diameter: 1.6 mm
- For efficient, gentle drilling into the front windscreen
- Allows the repair resin to penetrate all areas of the stone chip
- Prevents excessively deep or forceful drilling and slipping



02

03

Grip without drill

For the screen repair kit Screenrepair

► Item no. 2600-23



03

04

Metal drill

For the screen repair kit Screenrepair

► Item no. 2600-22

► Technical specifications

- Diameter: 1.6 mm



04

05

12 V electric drill with chuck

► Item no. 2600-04



05

**01
12 V UV lamp with timer**

► Item no. 2600-13-12

► Product description

- Only operate using 12V UV bulb with timer with 12V adapter cable (art. no. 2600-17)



**02
12 V adapter cable**

► Item no. 2600-17

► Product description

- Suitable for UV lamp 12V (2600-13-12) and 12V electric drill (2600-04)



**03
Tool holder with spring capsule**

► Item no. 2600-16



**04
220 V transformer**

► Item no. 2600-045



**05
Cutting blades, 10 pieces**

► Item no. 2600-01



**06
LED inspection lamp**

► Item no. 3721-503



**07
Glass drill bit 1.2 mm, 2 pieces**

► Item no. 2600-07

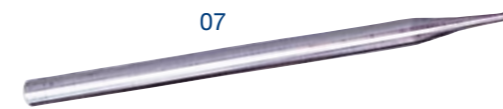

**08
Lapping polisher**

► Item no. 2600-09

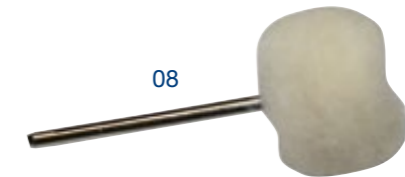

**09
Curing film**

► Item no. 2600-08



**10
Jointed inspection mirror with suction pad**

► Item no. 2600-06



01
Polish

- ▶ Item no. 2600-10



02
Repair resin

- ▶ Item no. 2600-11



03
Vacuum gel

- ▶ Item no. 2600-15



04
Finish resin

- ▶ Item no. 2600-12

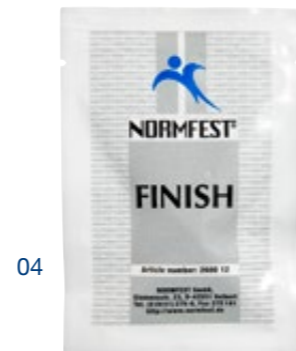

05
Spare UV tube

- ▶ Item no. 2600-14



06
Spacer
Universal

- ▶ Item no. 5502-100-001
- ▶ 1 packing unit = 5 pcs.

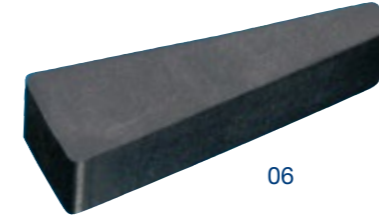

07
Moos ribbon
Incl. hard rubber block 5 x 7mm, self-adhesive

- ▶ Item no. 5502-107-001
- ▶ 15 m roll

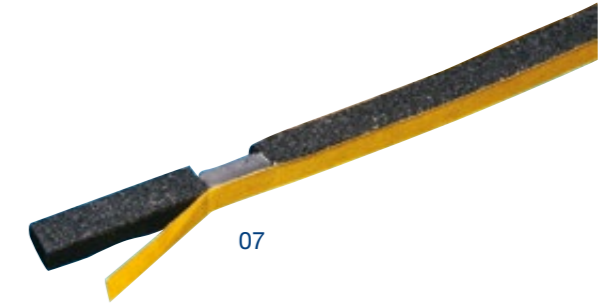

08
Retain profile
For side and rear windows, self-adhesive

- ▶ Item no. 5502-107-002
- ▶ 27 m roll

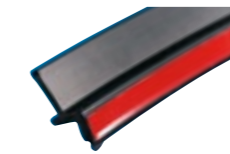

09
Moos ribbon
4 x 3mm, self-adhesive

- ▶ Item no. 5502-107-003
- ▶ 30 m roll



10
WS-Scheibenstopp
BMW E36 / E38 / E39

- ▶ Item no. 5502-101-003
- ▶ 1 sales unit = 56 pieces = 1 pallet



Vehicle reworking



Summary of paint preparation and paint sealing products

	Deep and heavy scratches	Many heavy scratches	Medium scratches	Light scratches	Holograms	Paint sealing			
Paint diagnosis									
Products	 Scratch Off Ultra polishing paste coarse 2000-341/1kg	 Scratch Off Ultra polishing paste coarse 2000-341/1kg	 Scratch Off Medium polishing paste medium 2000-343/1kg	 Scratch Finish polishing paste fine 2000-344-1/1L 2000-344-5/5L	 Perfect Gloss High-gloss polish 2000-344-500/500ml 2000-344-1/1L 2000-344-5/5L	 Perl Long-term surface Protection sealant 2897-327/500ml 2897-327-5/5L	 Speed Gloss Nano rapid sealer 2000-316-1/1L 2000-316-5/5L	 Speed-Wax Wax sealant 2000-330-1/1kg	 Paint-Guard Long-term sealant 2000-331-500/500ml
Application	 Rotary machines: 1,500 – 2,000 rpm Excenter machines: 1,700 – 2,200 rpm	 Rotary machines: 1,500 – 2,000 rpm Excenter machines: 1,700 – 2,200 rpm	 Rotary machines: 1,000 – 1,800 rpm Excenter machines: 1,700 – 2,200 rpm	 Rotary machines: 800 – 1,500 rpm Excenter machines: 1,700 – 2,200 rpm	 Rotary machines: 800 – 1,500 rpm Excenter machines: 1,700 – 2,200 rpm	 Processing Premium microfibre cloth, grey	 Processing Application sponge, black Premium microfibre cloth, grey	 Rotary machines: 1,500 – 2,000 rpm Excenter machines: 1,700 – 2,200 rpm	 Processing Application sponge, black Premium microfibre cloth, grey
	 Processing Natural lambskin Hard polishing sponge, yellow Spider polishing sponge for excenter	 Processing Hard polishing sponge, yellow Medium polishing sponge, orange Spider polishing sponge for excenter	 Processing Hard polishing sponge, yellow Medium polishing sponge, orange Spider polishing sponge for excenter	 Processing Medium polishing sponge, orange Soft polishing sponge, black Soft waffle sponge	 Processing Soft polishing sponge, black Soft waffle sponge Application sponge, black			 Processing Soft polishing sponge, black Soft waffle sponge Application sponge, black Microfibre cloth, grey	

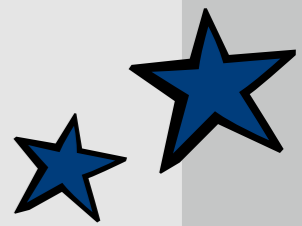

01

Scratch Off Ultra

Grinding paste, coarse

- ▶ Item no. 2000-341
- ▶ Contents: 1 kg
- ▶ Packing unit: 1

▶ **Technical specifications**

- Removes deep and heavy scratches
- Removes scratches completely (without fillers)
- Can be processed without water
- Long process time
- Leaves behind a unique deep gloss
- Silicone-free
-
- Rotary machines: 1,500 – 2,000 rpm
- Excenter machines: 1,700 – 2,200 rpm

Processing

- Spider sponge
- Polishing sponge, yellow
- Natural lambskin

Repolishing

- Microfibre cloth red
- Microfibre cloth blue



01

02

Scratch Off Medium

Grinding paste, medium

- ▶ Item no. 2000-342
- ▶ Contents: 1 kg
- ▶ Packing unit: 1

▶ **Technical specifications**

- Removes medium scratches
- Removes scratches completely (without fillers)
- Can be processed without water
- Long process time
- Leaves behind a unique high-gloss finish
- Silicone-free
-
- Rotary machines: 1,000 – 1,800 rpm
- Excenter machines: 1,700 – 2,200 rpm

Processing

- Spider sponge
- Polishing sponge, yellow
- Polishing sponge, orange

Repolishing

- Microfibre cloth red
- Microfibre cloth blue



02

03

Scratch Finish

Grinding paste, fine

- ▶ Item no. 2000-343
- ▶ Contents: 1 kg
- ▶ Packing unit: 1

▶ **Technical specifications**

- Removes light scratches
- Removes scratches completely (without filler)
- Long process time
- Leaves behind an excellent high gloss
- Can be processed by hand
- Silicone and wax-free
-
- Rotary machines: 800 – 1,500 rpm
- Excenter machines: 1,700 – 2,200 rpm

Processing

- Waffle sponge
- Polishing sponge, black
- Polishing sponge, orange



03



I LOVE THESE PRODUCTS

01

Perfect Gloss

High-gloss polish

- ▶ Item no. 2000-344-500
- ▶ Contents: 500 ml
- ▶ Packing unit: 1

- ▶ Item no. 2000-344-1
- ▶ Contents: 1 litre
- ▶ Packing unit: 1

- ▶ Item no. 2000-344-5
- ▶ Contents: 5 litres
- ▶ Packing unit: 1

▶ **Technical specifications**

- Removes holograms
- Leaves behind a long-lasting deep gloss
- Can be processed by hand
- Contains no volatile silicones
- Long-lasting protection
-
- Rotary machines: 800 – 1,500 rpm
- Excenter machines: 1,700 – 2,200 rpm

02

Push-pull closure

Colour: white

- ▶ Item no. 2000-356-2



Processing

Waffle sponge

Polishing sponge, black

Application sponge, black



03

Starter kit for paint preparation

11-piece kit

- ▶ Item no. 2000-003

Contents:

- 1x Coarse grinding paste, Scratch Off Ultra
- 1x Medium grinding paste, Scratch Off medium
- 1x Fine grinding paste, Scratch Finish
- 1x High-gloss polish, Perfect Gloss
- 1x Polishing foam
- 1x Medium polishing cloth, orange
- 1x Soft polishing cloth, black
- 1x Hard polishing cloth, yellow
- 1x Lambskin, white
- 1x Premium micro-fibre cloth
- 1x Microfibre cloth, red



01

03

01

Quick sealant
Speed-Gloss-Nano

- ▶ Item no. 2000-316-1
- ▶ Contents: 1 litre
- ▶ Packing unit: 1

- ▶ Item no. 2000-316-5
- ▶ Contents: 5 litres
- ▶ Packing unit: 1

- ▶ **Product description**
- Perfect shine effect
 - Effortless polishing without leaving any sticky residue
 - Suitable for cleaning without water
 - Contains carnauba wax

Processing
Application sponge, black
Premium microfibre cloth, grey

02

Wax sealing
Speed-Wax

- ▶ Item no. 2000-330-1
- ▶ Contents: 1 kg
- ▶ Packing unit: 1

- ▶ **Product description**
- Natural carnauba wax, enriched with high-quality synthetic components
 - For manual and machine application
 - Permanent protection against the elements
 - Long-lasting shine

 - Rotary machines: 1,500 – 2,000 rpm
 - Excenter machines: 1,700 – 2,200 rpm

Processing
Waffle sponge
Polishing sponge, black
Application sponge, black
Microfibre cloth, grey

03

Long-term sealant
Paint Guard

- ▶ Item no. 2000-331-500
- ▶ Contents: 500 ml
- ▶ Packing unit: 1

- ▶ **Technical specifications**
- Application by hand
 - Extra UV protection for long-lasting maintenance of the paint layer
 - Leaves behind a deep gloss
 - Free of volatile silicones

Processing
Application sponge, black
Premium microfibre cloth, grey

04

Long-term surface-protection sealant
Pearl

- ▶ Item no. 2897-327
- ▶ Contents: 500 ml
- ▶ Packing unit: 6

- ▶ **Product description**
- Protective coating & gloss enhancer
 - Increases scratch resistance and repels dirt
 - Easy to apply and polish
 - Takes just 10 minutes to cure
 - Solvent free
 - Contains silicone

Processing
Premium microfibre cloth, grey



01



02



03



04



01

Spray polish

Polit

- ▶ Item no. 2897-326
- ▶ Contents: 400 ml
- ▶ Packing unit: 12

▶ **Product description**

- Extremely quick and easy to use
- Antistatic
- Produces a uniquely deep shine
- High resistance to scratches and wear
- Contains silicone
- Ideal in combination with our Magic-Clean cleaning putty



01

02

Cleaning putty red

Magic-Clean

- ▶ Item no. 2000-26
- ▶ Contents: 200 g
- ▶ Packing unit: 1

▶ **Technical specifications**

- Sharp cleaning putty
- Removes all stubborn deposits from paint and rims
- such as rust bloom, brake dust, tar, tree resin, insects, burned-in metal dust and much more ...
- Supplied in a re-closable box

03

Cleaning putty blue

Magic Clean

- ▶ Item no. 2000-25
- ▶ Contents: 200 g
- ▶ Packing unit: 1

▶ **Product description**

- Effortlessly removes even the hardest dirt from painted surfaces
- Without aggressive solvents
- Removes industrial dust, surface rust, paint mist, dead insects, adhesive residue, tar and resin deposits



02

03



**ALL-STAR TRULY
REMOVES
ALL TYPES
OF DIRT!**

01

Power cleaner, exterior

All-Star

- ▶ Item no. 2000-312-5
- ▶ Contents: 5 litres
- ▶ Packing unit: 1

- ▶ Item no. 2000-312-30
- ▶ Contents: 30 litre
- ▶ Packing unit: 1

▶ **Product description**

- For universal use
- AOX-free
- Removes all types of stubborn road dirt
- Effortlessly removes oils, greases, nicotine and insects
- Gentle on paint, decorative trims and logos
- Specially made for high-pressure cleaners
- Can be used warm and cold

- **Mixing ratio:**

- High pressure cleaners: 1:1 to max. 1:6
- Low pressure / manual cleaning: 1:1 to max. 1:25

02

Interior/exterior power cleaner

All Star Protect

- ▶ Item no. 2000-318-5
- ▶ Contents: 5 litres
- ▶ Packing unit: 1

- ▶ Item no. 2000-318-30
- ▶ Contents: 30 litres
- ▶ Packing unit: 1

▶ **Product description**

- pH value 10
- Low colour and odour
- Aluminium-safe
(tested on the most common vehicles)
- AOX-free
- Free from solvents, silicates and phosphates

- **Mixing ratio:**

- High-pressure cleaners 1:5 to 1:20 (max. 50°C)
- Low pressure / manual cleaning 1:10 to max. 1:40



01



02

01
Power cleaner, inside/outside
Uni-Star

- ▶ Item no. 2000-02
- ▶ Contents: 5 litres
- ▶ Packing unit: 1

- ▶ Item no. 2000-02-30
- ▶ Contents: 30 litre
- ▶ Packing unit: 1

- ▶ **Product description**
- For universal use inside and outside
- AOX-free
- Removes all types of stubborn road dirt
- Effortlessly removes oils, greases, nicotine and insects
- Leaves behind no traces or matt surfaces
- Gentle on paint, decorative trims and logos

- Mixing ratio:
- High pressure cleaners: 1:1 to max. 1:10



02
Spout for 5 litre containers
▶ Item no. 2000-000-005

Spout for 30 litre containers
▶ Item no. 2000-000-030



03
Tarpaulin Cleaner
Cover-Star

- ▶ Item no. 2000-313-30
- ▶ Contents: 30 litre
- ▶ Packing unit: 1

- ▶ **Product description**
- Suitable for use with high-pressure cleaners
- Contains no halogenated hydrocarbons
- Free of adsorbent organic halogen compounds (AOX)
- Biodegradable



04
Rust film remover
Mega-Star

- ▶ Item no. 2000-10
- ▶ Contents: 5 litres
- ▶ Packing unit: 1

- ▶ **Product description**
- Cleaner for extreme inorganic dirt, e.g. concrete residue
- Effortlessly removes stubborn road dirt, brake dust, lime scale, hard deposits of oil, surface rust and rust bloom highly suitable for cleaning wheel rims
- AOX-free

- Mixing ratio: 1:10



01



03



04



01

Tar remover

Power Star Ultra

- ▶ Item no. 2000-04
- ▶ Contents: 5 litres
- ▶ Packing unit: 1

▶ **Product description**

- Loosens road tar
- Removes stickers on new cars
- Removes adhesive and sealing residue from all external plastic parts, paintwork and glass

03

Spout for 5 litre containers

- ▶ Item no. 2000-000-005

Spout for 30 litre containers

- ▶ Item no. 2000-000-030

02

Insect remover

Insect-Star Extreme

- ▶ Item no. 2000-322-5
- ▶ Contents: 5 litres
- ▶ Packing unit: 1

▶ **Item no. 2000-322-30**

- ▶ Contents: 30 litre
- ▶ Packing unit: 1

▶ **Product description**

- Special cleaner for the fast removal of dead insects
- Suitable for paintwork, glass, plastic and alkaline-resistant surfaces on all PCVs, HGVs, vans and trains
- Silicone-free



04

Active foam cleaner

Active Care

- ▶ Item no. 2000-401-30
- ▶ Contents: 30 litre
- ▶ Packing unit: 1

▶ **Product description**

- For soaking and cleaning heavy dirt and chemical pre-washes
- In car washes: Undiluted
- 1:1 using dosing pump (setting 8-20ml)

05

Drying accelerator

Speed-Dry

- ▶ Item no. 2000-404-30
- ▶ Contents: 30 litre
- ▶ Packing unit: 1

▶ **Product description**

- Supports the drying process by tearing open the water film
- Set car wash system to: neat
- 1:1 via the dosing pump (setting 8-20 ml)



01



02

03



04



06



01

Car Shampoo

Wash & Ready

- ▶ Item no. 2000-321-5
- ▶ Contents: 5 litres
- ▶ Packing unit: 1

- ▶ Item no. 2000-321-30
- ▶ Contents: 30 litre
- ▶ Packing unit: 1

▶ **Product description**

- Shampoo concentrate (can be diluted to 1:100)
- pH value 7.7

Effortlessly removes grime and road dirt
Leaves a shiny, streak-free surface



01

02

High gloss shampoo

Wash & Drive

- ▶ Item no. 2000-300-5
- ▶ Contents: 5 litres
- ▶ Packing unit: 1

- ▶ Item no. 2000-300-30
- ▶ Contents: 30 litre
- ▶ Packing unit: 1

▶ **Product description**

- Leaves a shiny and streak-free surface
- Silicone free
- AOX free
- Effortlessly removes road dirt and traffic deposits
- Cleans and polishes the paintwork in one application
- Can be diluted to: 15ml to 10 litres of warm water



02

03

Car-wash shampoo

Power Wash

- ▶ Item no. 2000-402-30
- ▶ Contents: 30 litre
- ▶ Packing unit: 1

▶ **Product description**

- Ideal for vehicle cleaning and providing good lubricity
- Set vehicle wash system to: neat
- 1:1 via the dosing pump (setting 8-15 ml)
- Machine cleaning: dilute up to 1:5,000 (depending on the level of soiling)
- Manual cleaning: dilute up to 1:50 (depending on the level of soiling).



03

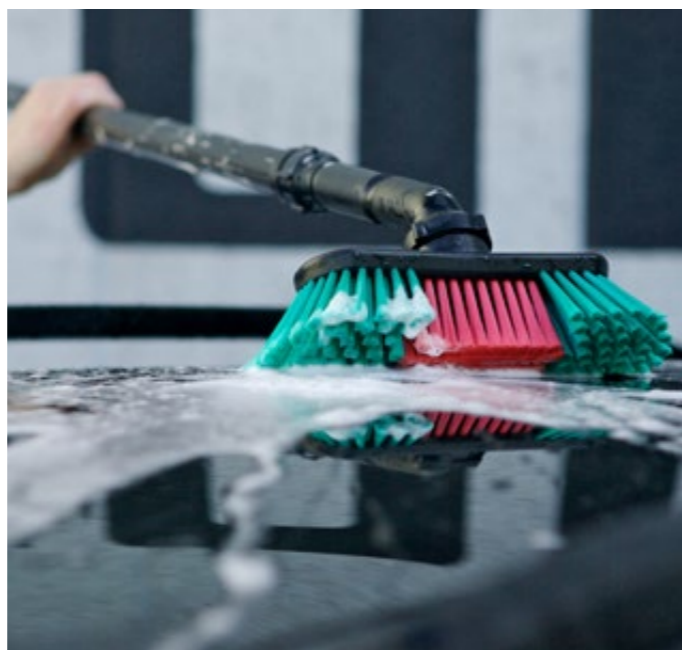

01
Scrubbing brushes
with water throughput

- ▶ Item no. 2000-810-3
- ▶ 130 x 260 mm (with pivot joint)

- ▶ Item no. 2000-810-4
- ▶ 90 x 400 mm

- ▶ Product description
- Brush type Soft/split
- Dimensions: 130mm x 260mm x 110mm
- Filament: 50mm
- Material: PP/PBT
- Thermal stability: 50°C

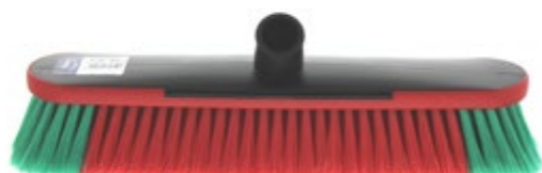

02
Rim brush
With water throughput

- ▶ Item no. 2000-810-9

- ▶ Product description
- Filament description: Soft/split
- Filament length: 50 mm
- Height: 105 mm
- Length: 240 mm
- Width: 150 mm
- Material: PP, PBT
- Max. temperature in use: 50 °Celsius



03
Rim brush, black
Soft for aluminium and chrome rims

- ▶ Item no. 2000-810-8

- ▶ Product description
- Filament description: Soft
- Filament length: 40 mm
- Colour: black
- Diameter: 65 mm
- Length: 330 mm
- Material: PP, hair/PP
- Max. temperature in use: 60 °Celsius



04
Telescopic handle
Without water throughput

- ▶ Item no. 2000-810-10

- ▶ Product description
- Diameter 31 mm
- Height 45 mm
- Length 1590 mm
- Max. length 2800 mm
- Width 45 mm
- Material Aluminium, Polypropylene
- Max. temperature in use 50 °Celsius



05
Telescopic handle
With water throughput

- ▶ Item no. 2000-810-6

- ▶ Technical specifications
- Connector: 1/2" hose connection (Europrofil / Hozelock, Gardena)
- Dimensions (HxWxD): 34mm x 1,600mm 2,900mm
- Material: Aluminium/PP
- Temperature: 50°C
- Pressure load: up to 6 bar

06
Working handle
Without water throughput

- ▶ Item no. 2000-810-5

- ▶ Technical specifications
- Dimensions: 31mm x 1500mm
- Material: Aluminium/PP
- Temperature: 50°C

07
Universal wall holder

- ▶ Item no. 2000-810-7

- ▶ Product description
- Dimensions (HxWxD): 60mm x 240mm x 170mm
- Material: PP/Rubber
- Thermal stability: 100°C



01

Silicone water squeegee

▶ Item no. 2000-810-30

▶ Technical specifications

- Ergonomically shaped water squeegee
- with 30-cm-wide highly flexible soft silicone lip
- Can be used on both sides
- Features a coarse thread connection for a telescopic pole (the thread is not compatible with Normfest processing poles)



01

02

Squeegee

350 mm, with handle connector on the grip

▶ Item no. 2000-810-1

▶ Technical specifications

- Dimensions (HxWxD): 50mm x 350mm 220mm
- Material: POM/rubber
- Temperature stability: 100°C



02

03

Squeegee

450 mm, with handle connector on the grip

▶ Item no. 2000-810-2

▶ Technical specifications

- Dimensions (HxWxD): 50mm x 450mm 220mm
- Material: POM/rubber
- Temperature stability: 100°C



03

04

Acid-free aluminium rim cleaner

Rimol Gold Protect

▶ Item no. 2897-328-30

▶ Contents: 30 litres

▶ Packing unit:

▶ Item no. 2897-328-500

▶ Contents: 500 ml

▶ Packing unit: 1

▶ Item no. 2897-328-5

▶ Contents: 5 litres

▶ Packing unit: 6

▶ Product description

- Acid-free
- Consists of 70% renewable raw materials, so environmentally friendly
- Contains no materials hazardous to health when evaporating off
- Gel-type viscosity
- Non-toxic
- Does not burn the skin
- Gentle cleaning



04



PROTECT THE GENTLE CHEMICAL!



01 Special aluminium wheel rim cleaner
Rimol Profi

- ▶ Item no. 2897-321-5
- ▶ Contents: 5 litres
- ▶ Packing unit: 1

- ▶ Item no. 2897-321-30
- ▶ Contents: 30 litre
- ▶ Packing unit: 1

- ▶ Product description
- Acidic
 - Easily removes stubborn dirt (burnt in brake dust, rust film, abraded rubber, heavy oil incrustations, road dirt, etc.)



01

02 Aluminium Rim Cleaner
Rimol

- ▶ Item no. 2897-320-1
- ▶ Contents: 500 ml
- ▶ Packing unit: 6

- ▶ Product description
- Acidic
 - Easily removes stubborn dirt (burnt in brake dust, rust film, abraded rubber, heavy oil incrustations, road dirt, etc.)

03 Silicone-free tyre care product
New Wheel Plus

- ▶ Item no. 2897-339-400
- ▶ Contents: 400 ml
- ▶ Packing unit: 12

- ▶ Product description
- Waterproof
 - Quick drying
 - Silicone-free

04 Silicone-based care product
New Wheel Extreme

- ▶ Item no. 2897-338-400
- ▶ Contents: 400 ml
- ▶ Packing unit: 12

- ▶ Product description
- Waterproof
 - Quick drying
 - Containing silicone



02



03



04



01
Engine compartment preservation
Motor-Fit

- ▶ Item no. 2000-307-1
- ▶ Contents: 1 litre
- ▶ Packing unit: 1

- ▶ Item no. 2000-307-5
- ▶ Contents: 5 litres
- ▶ Packing unit: 1

- ▶ Item no. 2000-307-30
- ▶ Contents: 30 litre
- ▶ Packing unit: 1

- ▶ **Product description**
- High shine
- Water dispersing
- Contains silicone
- Contains no aromatic solvents
- Protects electronic components



01

02
Care product for exterior plastic
Outplast

- ▶ Item no. 2000-319-500
- ▶ Contents: 500 ml
- ▶ Packing unit: 12

- ▶ **Product description**
- Provides long-lasting shine
- Excellent surface protection against environmental damage
- Silicone-free
- Not suitable for interior plastic parts or painted plastics

03
Plastic dyer
Plast-PT

- ▶ Item no. 2897-041
- ▶ Contents: 75 ml
- ▶ Packing unit: 1

- ▶ **Product description**
- Resistant to car washes, high pressure cleaners and solvents
- For dyeing plastic
- Incl. sponge

Black



02



03



04

04
Rubber care
Outdoor

- ▶ Item no. 2000-306-1
- ▶ Contents: 1 litre
- ▶ Packing unit: 1

- ▶ Item no. 2000-306-5
- ▶ Contents: 5 litres
- ▶ Packing unit: 1

- ▶ **Product description**
- Provides a pleasant, matt and long-lasting shine
- Has a high coverage rate and is quick drying
- Does not leaves sticky residue on the surface
- Leaves no marks in adjacent surfaces (paintwork, hub caps)
- Silicone-based

01
Intensive window cleaner
Topas

- ▶ Item no. 2897-310
- ▶ Contents: 400 ml
- ▶ Packing unit: 24

- ▶ Item no. 2000-03
- ▶ Contents: 5 litres
- ▶ Packing unit: 1

- ▶ **Product description**
- Silicone-free
- Also suitable for polycarbonate glass
- Safe for surfaces
- Foam formation only after the surface has been coated with the product

02
Universal foam cleaner
Multin

- ▶ Item no. 2897-342
- ▶ Contents: 600 ml
- ▶ Packing unit: 12

- ▶ **Product description**
- Active foam
- Cleans and degreases
- Powerful dissolving
- Leaves no residues
- Colour: White foam



03
Glass cleaner
Stries Protect

- ▶ Item no. 2897-340
- ▶ Contents: 500 ml
- ▶ Packing unit: 12

- ▶ Item no. 2897-340-5
- ▶ Contents: 5 litres
- ▶ Packing unit: 1

- ▶ Item no. 2897-340-30
- ▶ Contents: 30 litre
- ▶ Packing unit: 1

- ▶ **Product description**
- Removes dirt, marks, fingerprints, grease, nicotine, dead insects, etc.
- Free of silicone and ammonia
- Can be used on glass, polycarbonate glass



01



02



03



01
Rubber care pen
Rubber Fit

- ▶ Item no. 2897-335-75
- ▶ Contents: 75 ml
- ▶ Packing unit: 12

- ▶ Product description
- silicone-free
- splash- and saltwater resistant

Rubber Fit is a silicone-free care product for rubber components and seals in passenger cars. It contains natural waxes and beneficial additives, as well as being resistant to splash water, salt water, alkalis and acids.



01

02
Upholstery cleaner
Velvet

- ▶ Item no. 2897-307
- ▶ Contents: 400 ml
- ▶ Packing unit: 12

- ▶ Product description
- cleans and protects upholstery, carpets and roof lining
- removes greasy residue
- leaves a pleasant scent
- no vacuuming required



02

03
Leather care product
Ledanol

- ▶ Item no. 2000-310-1
- ▶ Contents: 1 litre
- ▶ Packing unit: 1

- ▶ Product description
- Cares for and protects leather
- Solvent-free
- Do not use on suede or similar surfaces



03

01

Intensive interior cleaner and care product

Interno Protect

- ▶ Item no. 2000-05
- ▶ Contents: 500 ml
- ▶ Packing unit: 12

- ▶ Item no. 2000-05-5
- ▶ Contents: 5 litres
- ▶ Packing unit: 1

▶ **Product description**

- Ready to use
- Free from acids and silicone
- Cares for hard and soft surfaces such as plastic, vinyl, chrome, sealing strips and door sill protectors, car leather, upholstery and carpets
- Not suitable for suede and Alcantara
- Leaves behind a matt finish on plastic surface and a pleasantly fresh fragrance
- Contains no hydrocarbon solvents

02

Cockpit spray, free of silicone and solvents

New Look Protect

- ▶ Item no. 2897-337-1

▶ **Technical specifications**

- Dust suppressing
- Antistatic
- Leaves a silky shine
- Leaves a neutral fragrance
- Cleaning and care for the dashboard, arm rests, mats, shelves, consoles

03

Interior Detailer

Crystal Ultra

- ▶ Item no. 2897-306
- ▶ Contents: 400 ml
- ▶ Packing unit: 6

▶ **Product description**

- Improved formula increases the cleaning and shine effect by up to 30%
- Application in cockpits, on door trims, foot mats and seats (except displays and tachometers)
- Loosens grease residue
- Leaves the vehicle looking and smelling new
- Acts anti-statically

04

Interior plastic care product

Indoor

- ▶ Item no. 2000-308-1
- ▶ Contents: 1 litre
- ▶ Packing unit: 1

▶ **Item no. 2000-308-5**

- ▶ Contents: 5 litres
- ▶ Packing unit: 1

▶ **Product description**

- Suitable for plastics and rubbers in the interior, cockpit, dashboards, door trims, storage trays, wooden covers and leather
- Care product containing silicone gives plastic a like-new appearance and leaves behind no residue
- Very easy to apply
- Free from volatile silicones
- Silk matt finish



01

02

03

04

01
Odour destroyer and air freshener
Aerofit Power

- ▶ Item no. 2000-309-400
- ▶ Contents: 400 ml
- ▶ Packing unit: 12

- ▶ **Product description**
- Immediately eliminates smells and freshens the interior
 - Long-lasting and economical
 - A high-pressure system with an extremely concentrated active ingredient
 - One squirt is sufficient for a large area
 - Raspberry fragrance



02
Odour destructor
Aerofit Plus

- ▶ Item no. 2000-309-2
- ▶ Contents: 1 litre
- ▶ Packing unit: 1

- ▶ **Product description**
- Can be used on all fabric surfaces inside the vehicle as well in ventilation ducts without sensors
 - Effectively eliminates all unpleasant odours, e.g. nicotine
 - Solvent-free
 - Can be applied using a normal spray or pressure pump spray bottle
 - Also very easy to apply using a wet vacuum cleaner or nebuliser
 - Silicone-free



03
Manual sprayer flexible

- ▶ Item no. 2000-802-2

- ▶ **Product description**
- Suitable for overhead work
 - Leak-proof, with Viton seal
 - Steplessly adjustable nozzle – from fine spray to jet



04
Odour eliminator and air freshener
Aerofit Fresh

- ▶ Item no. 2000-309-600
- ▶ Contents: 600 ml
- ▶ Packing unit: 12

- ▶ **Product description**
- Quick to work
 - Does not leave any marks
 - Biological fragrance
 - Removes bad smells
 - No heavy metals
 - Simple to use
 - A little goes a long way
 - Citrus fragrance

01

Medium polishing sponge

Colour: orange

- ▶ Item no. 2000-352-75
- ▶ Diam. 75 mm, PU 4

- ▶ Item no. 2000-352-150
- ▶ Diam. 150 mm, PU 2

▶ **Technical specifications**

- Medium-hard polishing sponge
- Perfect for treating used and weathered paintwork
- Suitable for use with grinding and polishing pastes
- Polish and seal in one step



01



02

Hard polishing sponge

Colour: yellow

- ▶ Item no. 2000-351-75
- ▶ Diam. 75 mm, PU 4

- ▶ Item no. 2000-351-150
- ▶ Diam. 150 mm, PU 2

▶ **Technical specifications**

- High intake capacity for abrasive pastes
- Perfect for removing heavy scratches



02

04

Spider polishing sponge

Colour: blue with excenter

- ▶ Item no. 2000-355-150
- ▶ Diam. 150 mm, PU 2

▶ **Technical specifications**

- Has fine cuts throughout so that the polish is absorbed into the sponge more effectively and therefore can be worked into the paint surface for longer
- Can withstand the high stroke of our excenter polishing machine very effectively
- Ideal for use with the polishing pastes Scratch Off Ultra and Scratch Off Medium



04

03

Soft polishing sponge

Colour: black

- ▶ Item no. 2000-353-75
- ▶ Diam. 75 mm, PU 4

- ▶ Item no. 2000-353-150
- ▶ Diam. 150 mm, PU 2

▶ **Technical specifications**

- Perfect for applying fine polishing pastes and surface sealants
- Suitable for removing holograms



03



01

Waffle polishing sponge

Colour: black

- ▶ Item no. 2000-354-75
- ▶ Diam. 75 mm, PU 4

- ▶ Item no. 2000-354-150
- ▶ Diam. 150 mm, PU 2

- ▶ Technical specifications
- With integrated interface pad
- Extremely soft sponge
- Ideal for removing holograms



01

02

Lambskin

Colour: white

- ▶ Item no. 2000-350-75
- ▶ Diam. 75 mm, PU 4

- ▶ Item no. 2000-350-150
- ▶ Diam. 150 mm, PU 2

- ▶ Product description
- with integrated interface pad
- Extremely aggressive abrasive medium
- High intake capacity for abrasive pastes
- Perfect for removing heavy scratches, orange peel effect and dust inclusions



02

03

Application sponge

black

- ▶ Item no. 2000-209-130
- ▶ Diam. 130 mm, PU 1

- ▶ Product description
- Ergonomic handle for easy and safe use with:
- Speed-Wax wax sealant (art. no. 2000-330-1)
- Speed Gloss Nano rapid sealant (art. no. 2000-316)



03



04

3in1 hook-and-loop polishing disks

- ▶ Item no. 4666-075-150

- ▶ Product description
- Consists of three different-sized hook-and-loop disks: 75mm, 120mm and 145 mm
- No more resetting of hook-and-loop holder disks to different sizes
- Suitable for all of our polishing sponges and sheepskins
- Provides high flexibility
- Has an M14 machine retainer



04

05

Velcro disc

- ▶ Item no. 4666-150-1
- ▶ Ø 150 mm

- ▶ Item no. 4666-075-1
- ▶ Ø 75 mm

- ▶ Product description
- With Velcro-type attachment for polishing sponges
- M14 mounting thread



05



02

Mini angular polisher

With grip cover

- ▶ Item no. 8697-114-11
- ▶ Ø 160 mm

▶ **Product description**

- Max. supporting disk Ø: 125 mm
- Max. polishing pad diameter: 140 mm
- Weight: 1.9 kg
- Drive spindle: M14
- Power output 700 Watt
- Power consumption: 1,200 W
- Idle speed: 1,200 - 3,700 rpm



02

01

Excenter polishing machine

Tornador Ø 150 mm

- ▶ Item no. 8697-114-13

▶ **Product description**

- max. polishing pad diameter: 180 mm
- Max. supporting disk Ø: 150 mm
- Speeds: 1,700 - 4,200 rpm
- Eccentric movement: 21mm
- Power output: 900W
- 10-m cable
- Speed smoothly adjustable
- Detachable additional handle
- 240V/50Hz
- Weight: 4.28 kg



01

03

Polish Flex angle polisher

With powerful 1,400 Watt motor

- ▶ Item no. 8697-114-12

▶ **Product description**

- Max. polishing pad diameter: 200 mm
- Max. supporting disk Ø: 150 mm
- Idling speed: 380-2100 /min
- Power consumption: 1,400 W
- Power output: 880 Watt
- Tool retainer: M 14
- Dimensions (L x H): 402x117 mm
- Weight: 2.3 kg



- A handle is included in the package
- The associated replacement carbon brushes are available under article number 8697-114-120



03

01

Insect sponge
extra strong

- ▶ Item no. 2000-601
- ▶ 110 x 70 x 40 mm

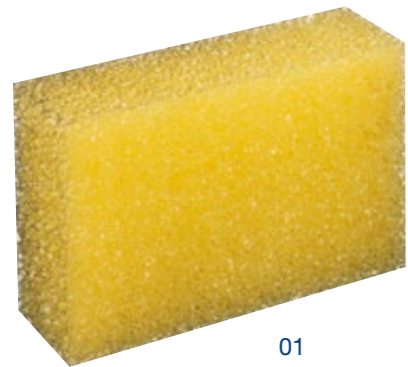

01

02

Car sponge
Classic

- ▶ Item no. 2000-602
- ▶ 180 x 120 x 65 mm



02

05

Car sponge
Hydro

- ▶ Item no. 2000-602-1
- ▶ 195 x 120 x 70 mm

- ▶ Product description
- With ergonomic design
- Very absorbent



05



03

Car sponge
pressed viscose sponge

- ▶ Item no. 2000-604
- ▶ 130 x 90 x 10 mm

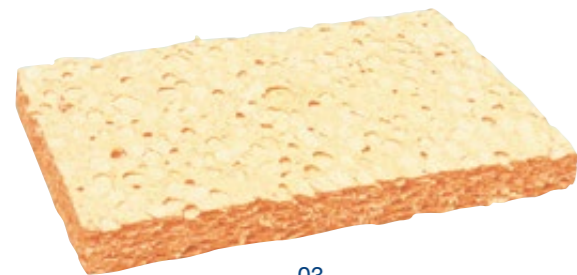

03

04

Wheel rim sponge

- ▶ Item no. 2000-603
- ▶ 165 x 105 x 53 mm

- ▶ Product description
- Dimensions: 165 x 105 x 53 mm



04

06

Dirt brush
with bow-type handle and scraping edge

- ▶ Item no. 2000-105

- ▶ Product description
- Length: 160 mm
- Bristle length: 25 mm



06

01

Microfibre cloth red

- ▶ Item no. 2000-740-40
- ▶ 400 x 400 mm

▶ Product description

- High pile
- Rounded corners
- Dimensions: 40 x 40 cm
- Colour: red
-
- Wash at up to 40 °C
- Dry at up to 30 °C
- Do not use softeners or bleach



01

02

Microfibre cloth blue

- ▶ Item no. 2000-640-40
- ▶ 400 x 400 mm

▶ Product description

- Blue
- 40 x 40 cm
-
- Wash at up to 40 °C
- Dry at up to 30 °C
- Do not use softeners or bleach



02

03

Microfibre cloth

King Screen

- ▶ Item no. 2000-840-40
- ▶ 400 x 400 mm

▶ Product description

- Streak-free shine if a flash
- Reinforced weave with patterned surface
- Can be used wet and dry
- Lint free



03



04

Tornador® Towel

Drying cloth

- ▶ Item no. 2000-766-43
- ▶ 660 x 430 mm

▶ Product description

- Very soft
- Washable at 30° C
- Resistant to most oils, grease and chemicals
- For gentle drying of all delicate surfaces
- Dries without streaking or lint



04

05

Premium microfibre cloth

grey

- ▶ Item no. 2000-745-40
- ▶ 400 x 400 mm

▶ Product description

- Extremely soft plush cloth
- Scratch-free polishing out of polish residue
-
- Wash at up to 40 °C
- Dry at up to 30 °C
- Do not use softeners or bleach



05

01

Carbon sanding block

- ▶ Item no. 4675-001-500
- ▶ 1,500 grit, yellow

- ▶ Item no. 4675-002-000
- ▶ 2,000 grit, green

- ▶ Item no. 4675-003-000
- ▶ 3,000 grit, red

▶ **Product description**

- For removing scratches levelling unevenness

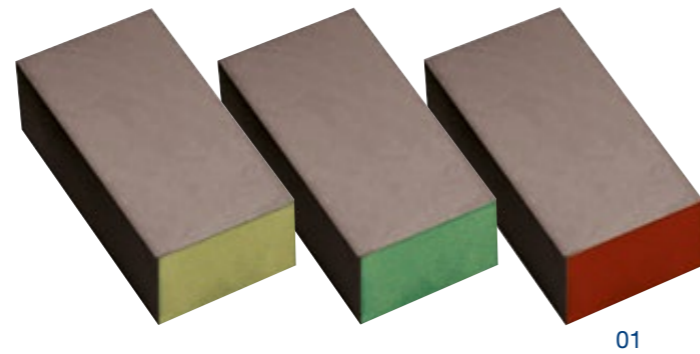

01

02

Abrasive fleece pads

Ultra fine, grey

- ▶ Item no. 4585-455
- ▶ Pads 152 mm x 229 mm

▶ **Product description**

- With 1,500 grit
- Highly flexible
- Greater performance due to innovative scattering
- For wet and dry applications
- Also suitable for pet hair
- Grit material: Aluminium oxide ultra fine
- Binding agent: Synthetic resin
- Carrier material: Fleece
- Coating: Total coating, three-dimensional
- Colour: Grey



02

03

Pet hair removal brush

with rubber V bristles

- ▶ Item no. 2000-107

▶ **Product description**

- Completely removes animal hair, dust and other small particles
- Handle can be rotated 90°, facilitating work in corners
- With rubber lip for removing water and snow from windscreens



03

04

Fleece roll

perforated, 400 pcs. to tear off

- ▶ Item no. 7875-500
- ▶ 29 x 38 cm

▶ **Product description**

- Colour: White
- Highly absorbent
- Excellent tear and wear strength, wet or dry,
- Washable and wringable
- Solvent-resistant
- Silicone-free
- Food safe
- Perforated
- 400 perforations
- Roll length: 152m



04

05

Cellulose pads roll

2-ply, 600 pcs. to tear off

- ▶ Item no. 7875-1
- ▶ 27 x 40 cm, PU: 2

▶ **Product description**

- Roll length: 255 m
- Colour: white
- Very absorbent
- 2-ply
- Dimensions: 23.5 x 34 cm



05



01
Cleaning paper roll
2-ply, 1,000 tear-off sheets

- ▶ Item no. 7875-502
- ▶ 22 x 36 cm embossed, fully coated

- ▶ Item no. 7875-503
- ▶ 36 x 38 cm embossed, fully coated

- ▶ Product description
- Colour: blue
- PU: 2



01

02
Cleaning paper roll
3-ply, 1,000 tear-off sheets

- ▶ Item no. 7875-504
- ▶ 38 x 36 cm

- ▶ Product description
- Layers: 3
- Tear-off sheets: 1,000 / roll
- Sheet size: 38 x 36 cm
- Roll diameter: 29cm
- Roll length: 350m
- Colour: blue
- embossed, fully bonded
- Packaging unit: 2 pieces



02

03
Rolls of lint-free fleece cloth
500 tear-off sheets per roll, 38x30 cm

- ▶ Item no. 7875-505
- ▶ 38x30 cm

- ▶ Technical specifications
- Lint free
- Can be used wet and dry
- Biodegradable
- Components: 55% sawdust – 45% polyester (no binding agents)
- Colour: Turquoise
- Solvent resistant
- Highly absorbent
- Sold as a double roll
- 500 tear-off sheets per roll
- Sheet height: 38 cm
- Sheet width: 30 cm



03

04
Fibre fleece cleaning cloth
perforated, 400 pcs. to tear off

- ▶ Item no. 7875-5
- ▶ 29 x 39 cm

- ▶ Product description
- Very absorbent
- High cotton content
- Can be wrung out
- Tear resistant
- Resistant to most solvents
- 2 rolls per pack
- 400 cloths per roll
- 29 x 38 cm
- Perforated for easy tearing
- Textile cloths (70% cotton, 15% synthetic fibres, 15% PP)



04

01

Pressure pump spray bottle 1 litre

► Item no. 2897-333-100

► Product description

- Operational overpressure 3 bar
- Suitable replacement sealant (optionally available):
Art. no. 2897-333-101
- Empty
- Capacity 1 litre
- Labels to improve identification separately available
- For filling with the following Normfest products:
- Bremtec brake cleaner
- Power-Star tar remover
- Motor-Fit engine compartment conservation
- Oxim rust remover



01

02

Pump spray bottle

for acidic liquids

► Item no. 2897-333-150

► Product description

- Operational pressure 3 bar
- Suitable replacement seal: (optionally available):
Art. no.: 2897-333-151
- Empty
- Capacity 1 litre
- Labels to improve identification separately available
-
- For filling with the following Normfest products:
- Rimol wheel rim cleaner
- Rimol Gold wheel rim cleaner
- Mega-Star rust-film remover



02

03

Pump spray bottle 1 litre

► Item no. 2000-100

► Product description

- Operational overpressure 3 bar
- Suitable replacement sealant (optionally available):
Art. no. 2000-101
- Empty
- Capacity 1 litre
- Labels to improve identification separately available
-
- For filling with the following Normfest products:
- Uni-Star universal cleaner
- All-Star power cleaner
- Interno intensive interior cleaner & care
- Stries glass cleaner
- Cover-Star awning cleaner
- Topas intensive windscreen cleaner
- All-Star Protect powerful cleaner and degreaser
- Indoor interior plastic care
- Outdoor rubber care
- Insect-Star Extreme insect remover



03

04

Processing bottle

No closure

► Item no. 2000-356-500

► 500 ml

► Item no. 2000-356-1

► 1 litre

► Product description

- Empty processing bottle for filling with any chemical product from the Normfest preparation range



04

05

Push-pull closure

Colour: white

► Item no. 2000-356-2



05

01

Hand sprayer

► Item no. 2000-802

► Product description

- Leak-proof
- Smoothly adjustable nozzle from fine spray to jet

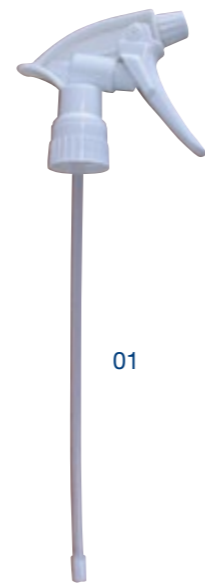

02

Hand sprayer

► Item no. 2000-802-1

► Product description

- For 1-litre bottles
- Leak-proof
- Smoothly adjustable nozzle from fine spray to jet



03

Manual sprayer flexible

► Item no. 2000-802-2

► Product description

- Suitable for overhead work
- Leak-proof, with Viton seal
- Steplessly adjustable nozzle – from fine spray to jet



04

Tornador Gun Black

Compressed air-driven suction feed spray gun

► Item no. 8696-4-83

► Technical specifications

- Designed for continuous professional use
- Full power potential at a pressure of 4.5 bar
- Allows both dry and wet cleaning
- Low compressed-air consumption of 270 l/min at 6.0 bar
- Perfect results in combination with Uni, All-Star and All-Star products
- Area of application: Dashboards, ventilation ducts, upholstery, mats, interior trims, convertible soft tops, etc.
-
- Single- or double-finger operation (without crushing the ring finger)
- Non-slip, insulated handle
- Reduced hand/arm vibration
- Compressed-air connection with 32° angle prevents the hose becoming kinked
- Recessed grips make it easier to screw the cleaning cup on and off
- Fill-level display for accurate mixing
- Counterbalance valve lets you work over your head
-
- Ergonomic, insulated and low-vibration
- Low wear and maintenance
- Optimized air consumption
- Suitable for 2.2kW - 240V piston compressors
- Also for overhead working



Internal guide tube

for Tornador Gun Black

► Item no. 8696-4-833

Funnel

for Tornador Gun Black

► Item no. 8696-4-835

01

Tornador Gun

Compressed air-driven suction feed spray gun

► Item no. 8696-3-83

► Technical specifications

- Cleans both dry and damp
- Perfect for Uni or All-Star
- Compressed-air consumption of 237 l/min at 8 bar
-
- the original
- ergonomic, freeze-protection and less vibrations
- with proven Tornador Tube Technology
- for hard to reach and tight areas
- releases an ultra-fine mist of cleaning solution
- also for overhead work



01



Intake sphere with riser pipe

► Item no. 8696-3-831



Internal guide tube

► Item no. 8696-3-833



Rotating hose

► Item no. 8696-3-834



Funnel

► Item no. 8696-3-835

02

Pressure sprayer

for all Normfest cleaners

- Item no. 2000-806
- Without hand pump; with closure

► Product description

- 5 litre plastic container
- 4 bar operating pressure
- with litre scale
- Chemical-resistant Viton seals
- 1.5 m chemical-resistant spray hose
- 50 cm curved stainless steel spray tube
- Flat spray nozzle with stainless steel head, diameter 0.91 mm
- Relief valve
- Compressed air connection
- Integrated feed hopper
- Stainless steel revolver valve

03

Spare closure

► Item no. 2000-806-2

04

Hand pump

For Uni-Star, All-Star and Topas

► Item no. 2000-806-1



02

04

03



02

High pressure cleaner

HD 5/15 C Plus

▶ Item no. 2000-550-2

▶ Product description

- Extended trigger gun, with Easy Press
- Trigger gun with soft grip
- High-pressure hose 10 m
- Steel tube 850 mm
- Triple nozzle manual (0° / 25° / 40°)
- Anti-twist system
- Pressure switch control



02

01

Wet and dry vacuum cleaner

NT 35/1 TACT TE

▶ Item no. 2000-550-1

▶ Product description

- Suction hose 2.5 m
- Metal suction tube 2 x 0.5 m
- Paper filter bag
- Wet and dry floor tool 300 mm
- Crevice tool
- Connector for electric tools
- Auto shutdown when max. level is reached
- Safety class I
- Maintenance-free suction turbines



01

Paper filter bags

▶ Item no. 2000-550-100

▶ PU: 5

03

Spray-extraction cleaner

Puzzi 8/1 C

▶ Item no. 2000-550-3

▶ Product description

- Spray hose 2.5 m, with integrated water feed
- Hand tool
- Power cable 7.5 m
- Upholstery nozzle



03

Car air conditioning



01

Air conditioning system cleaner

Viro One Shot Plus

- ▶ Item no. 2897-301
- ▶ Contents: 100 ml
- ▶ Packing unit: 10

▶ **Product description**

- For quick, easy and hygienic cleaning
- Eliminates dead microorganisms thoroughly
- Prevents allergic reactions
- Leaves a pleasant smell that lasts
- Contents are sufficient for one application
- Basis: alcohol

02

Air conditioning and ventilation system cleaner

Viro Air Fresh Plus

- ▶ Item no. 2897-302
- ▶ Contents: 300 ml
- ▶ Packing unit: 12

▶ **Product description**

- Spray enters the ventilation system directly via the capillary tube
- Long-lasting disinfection
- Leaves a pleasant citrus fragrance
- Contents sufficient for up to three applications
- Basis: alcohol

03

Air conditioning evaporator cleaner

Viro Vaporizer

- ▶ Item no. 2897-303
- ▶ Contents: 400 ml
- ▶ Packing unit: 12

▶ **Product description**

- Performs high-pressure flushing
- Effective in every corner of the evaporator
- Kills germs, bacteria and moulds
- Prevents the growth of microorganisms
- Ensures healthy and pleasant smelling air inside the vehicle
- Incl. 60 cm hose with rotor nozzle
- Sufficient product for one A/C system



01



02



03





01

Trace-gas leak-testing set

Leak-testing set based on 95% nitrogen and 5% hydrogen

► Item no. 5000-5

► Product description

- Content of the full set in the case:
- Hydrogen leak-testing set
- Trace-gas pressure reducer
- Test armature
- Connection hose between trace-gas pressure reducer and high-pressure quick coupling
- Connection hose between low-pressure quick coupling and test armature
- High-pressure quick coupling
- Low-pressure quick coupling
- Gas cylinder content: 2 litres
- Ear buds
- Power adaptor
- CD-ROM



01

02

Set of LED UV bulbs 3.6V 150W with UV glasses

► Item no. 5000-201

► Product description

- The UV bulb has a screened reflector and an electrical connection to the cigarette lighter
- An adapter for connection to the car battery is included
- The UV light of the LED bulb illuminates fluorescent leak-test liquid
- Contents: 1x UV bulb (incl. batteries), 1x UV glasses



02

03

UV safety goggles

► Item no. 5000-202

► Product description

- For work with fluorescent leak-test liquids



03

04

Quick coupling R1234YF BF

► Item no. 5000-5-002

► Product description

- High-pressure
- Connecting thread M12 x 1.5mm
- Colour: blue



04

05

Quick coupling R1234YF RF

► Item no. 5000-5-003

► Product description

- Low-pressure
- Connecting thread M12 x 1.5mm
- Colour: red



05

06

Adapter R1234YF

► Item no. 5000-5-001

► Product description

- Connecting thread: M12 X 1.5



06

01
UV leak search fluid
Tracer

- ▶ Item no. 5000-303
- ▶ Contents: 236 ml
- ▶ Packing unit: 1

▶ **Product description**

- This leakfinder additive does not contain solvents
- Ideal for use in combination with refrigerating oils (PAG, mineral oil, ester)
- Safe for all vehicle A/C systems and A/C service instruments
- Manufacturer approval
- Sufficient for approx. 25 PCV applications

02
UV leak-detector fluid for hybrid vehicles in combination with refrigerant R134a and 1234yf
UV hybrid

- ▶ Item no. 5000-304
- ▶ Contents: 240 ml
- ▶ Packing unit: 1

▶ **Product description**

- for use in combination with refrigerating oils (PAG, mineral oils, ester)
- Completely harmless for all hybrid-vehicles air conditioning systems and service equipment
- Suitable for both refrigerants (R134a & HFO1234yf)
- Does not attack O-rings or seals
- Non-conductive

03
UV-Additiv Tracer®
for R1234yf refrigerant

- ▶ Item no. 5000-305
- ▶ Contents: 237 ml
- ▶ Packing unit: 6

▶ **Product description**

- This leakfinder additive does not contain any solvents
- For use in combination with refrigerating oils (PAG, mineral oil, ester)
- Safe for all vehicle A/C systems and A/C service instruments
- Manufacturer's approval
- For approx. 25 car applications

04
Oil-Fluid
Fluorescent leakfinder fluid for engines and gearboxes

- ▶ Item no. 5000-205-1
- ▶ Contents: 25 ml
- ▶ Packing unit: 1

▶ **Product description**

- Sufficient for one vehicle/one application



04

05
Water-Fluid
Fluorescent leakfinder fluid for cooling systems

- ▶ Item no. 5000-206-1
- ▶ Contents: 25 ml
- ▶ Packing unit: 1

▶ **Product description**

- Sufficient for one vehicle/one application



05

06
PAG 46 Oil
AC compressor oil for R134a refrigerant - Low viscosity

- ▶ Item no. 5000-220
- ▶ Contents: 250 ml
- ▶ Packing unit: 1

▶ **Technical specifications**

- The product is not suitable for refrigerant R1234yf, hybrid and electric vehicles as well as electrically



06

07
PAG 100 Oil
AC compressor oil for R134a refrigerant - Low viscosity

- ▶ Item no. 5000-221
- ▶ Contents: 250 ml
- ▶ Packing unit: 1

▶ **Technical specifications**

- The product is not suitable for refrigerant R1234yf,



07



01

02

03

NEU

01

Climate-control compressor oil
PAG46 OIL 1234yf / for coolant 1234yf

- ▶ Item no. 5000-218
- ▶ Contents: 250 ml
- ▶ Packing unit: 12

▶ **Product description**

- A multigrade compressor oil for all cars, trucks, buses and agricultural equipment filled with 1234yf coolant
- For hybrid vehicles filled with 1234yf coolant
- Perfectly lubricates and cools climate-control compressors
- Guarantees thermal stability in compressors

02

Multigrade compressor oil
Multi POE Oil Premium

- ▶ Item no. 5000-219
- ▶ Contents: 1 litre
- ▶ Packing unit: 1

▶ **Product description**

- A multi-range compressor oil for A/C systems using 1234yf or R134a as refrigerant
- Can also be used on A/C systems in hybrid vehicles filled with 1234yf or R134a
- To reduce wear, lubricate and cool A/C compressors in the refrigerant range
- Compatible with all known mineral, ester and PAG oils



05

Adapter set for refrigerant R1234yf

- ▶ Item no. 5000-229-1

▶ **Product description**

- A differentiation is made between the following adapters:
 - Honeywell 1/2"-16 ACME LH
 - DuPont W 21.8 x 1/14"LH
- The DuPont adapter can also be used for our cylinders.

03

Refrigerant R134A

- ▶ Item no. 5000-225-9

- ▶ **Product description**
- 12.7 kg reusable bottle

04

Refrigerant R1234yf

- ▶ Item no. 5000-229

- ▶ **Product description**
- 5.0 kg Reusable bottle



01

02



03

04

05

Car climate control

01 Sealing compound for A/C systems

Quick-Seal Cold

- ▶ Item no. 5000-230
- ▶ Contents: 40 ml
- ▶ Packing unit: 1

▶ Product description

- Used to seal micro-leaks in shaft seals, hoses and O-rings in car climate-control systems
- Contents sufficient for one use
- The product contains 44 grams of R134A coolant
- CAUTION! Quick-Seal-Cold must not be used in hermetically-sealed systems!
- IMPORTANT! Use only possible with the adapter, available separately. (art. no. 5000-230-1)

02 Thermal paper roll for air conditioning service equipment

- ▶ Item no. 5000-235

▶ Product description

- Special printer paper for ASC-series thermal printers
- Roll width: 58 mm
- Length: 10 m

Air conditioning accessories

03 Adapter hose for Quick-Seal Cold

- ▶ Item no. 5000-230-1

▶ Product description

- Hose for Quick-Seal Cold filling
- Re-usable

04 Adapter, 1/4" SAE outer thread with seal

- ▶ Item no. 5000-226-1

▶ Product description

- HD connector adapter for gaseous removal of coolant at service-station connections



01



02

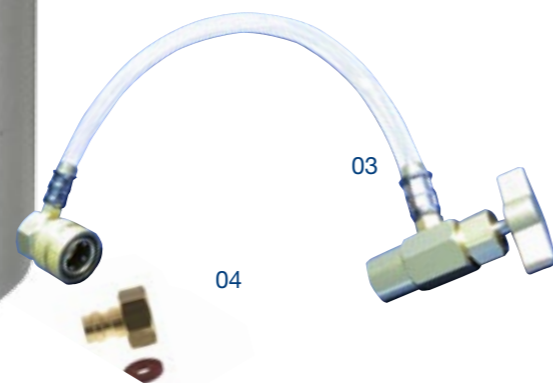

04

03



Item no.	Model
5000-002	Inner diameter 7.50 mm Cross-section 2.00 mm Quantity 20 pieces



Item no.	Model
5000-009	Inner diameter 10.80 mm Cross-section 2.40 mm Quantity 20 pieces



Item no.	Model
5000-028	Inner diameter 17.17 mm Cross-section 1.78 mm Quantity 20 pieces



Item no.	Model
5000-047	Inner diameter 12.01 mm Cross-section 1.88 mm Quantity 20 pieces



Item no.	Model
5000-003	Inner diameter 4.47 mm Cross-section 1.78 mm Quantity 20 pieces



Item no.	Model
5000-012	Inner diameter 7.65 mm Cross-section 1.78 mm Quantity 20 pieces



Item no.	Model
5000-029	Inner diameter 17.00 mm Cross-section 2.00 mm Quantity 20 pieces



Item no.	Model
5000-050	Inner diameter 7.65 mm Cross-section 1.63 mm Quantity 20 pieces



Item no.	Model
5000-004	Inner diameter 8.00 mm Cross-section 2.00 mm Quantity 20 pieces



Item no.	Model
5000-013	Inner diameter 10.50 mm Cross-section 2.00 mm Quantity 20 pieces



Item no.	Model
5000-032	Inner diameter 6.02 mm Cross-section 2.62 mm Quantity 20 pieces



Item no.	Model
5000-052	Inner diameter 9.60 mm Cross-section 1.88 mm Quantity 20 pieces



Item no.	Model
5000-005	Inner diameter 9.25 mm Cross-section 2.39 mm Quantity 20 pieces



Item no.	Model
5000-016	Inner diameter 9.25 mm Cross-section 1.78 mm Quantity 20 pieces



Item no.	Model
5000-034	Inner diameter 10.77 mm Cross-section 2.62 mm Quantity 20 pieces



Item no.	Model
5000-060	Inner diameter 9.50 mm Cross-section 2.50 mm Quantity 20 pieces



Item no.	Model
5000-006	Inner diameter 8.92 mm Cross-section 1.83 mm Quantity 20 pieces



Item no.	Model
5000-017	Inner diameter 10.82 mm Cross-section 1.78 mm Quantity 20 pieces



Item no.	Model
5000-035	Inner diameter 12.37 mm Cross-section 2.62 mm Quantity 20 pieces



Item no.	Model
5000-061	Inner diameter 10.80 mm Cross-section 2.40 mm Quantity 20 pieces



Item no.	Model
5000-007	Inner diameter 6.07 mm Cross-section 1.78 mm Quantity 20 pieces



Item no.	Model
5000-021	Inner diameter 14.30 mm Cross-section 2.30 mm Quantity 20 pieces



Item no.	Model
5000-036	Inner diameter 13.94 mm Cross-section 2.62 mm Quantity 20 pieces



Item no.	Model
5000-062	Inner diameter 11.50 mm Cross-section 2.50 mm Quantity 20 pieces



Item no.	Model
5000-008	Inner diameter 10.00 mm Cross-section 2.50 mm Quantity 20 pieces



Item no.	Model
5000-026	Inner diameter 15.68 mm Cross-section 1.93 mm Quantity 20 pieces



Item no.	Model
5000-043	Inner diameter 15.47 mm Cross-section 3.53 mm Quantity 20 pieces



Item no.	Model
5000-063	Inner diameter 13.40 mm Cross-section 1.78 mm Quantity 20 pieces



Item no.	Model
5000-064	Inner diameter 13.80 mm
	Cross-section 2.40 mm
	Quantity 20 pieces

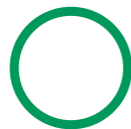

Item no.	Model
5000-069	Inner diameter 7.00 mm
	Cross-section 2.50 mm
	Quantity 20 pieces



Item no.	Model
5000-065	Inner diameter 14.25 mm
	Cross-section 2.40 mm
	Quantity 20 pieces



Item no.	Model
5000-070	Inner diameter 6.95 mm
	Cross-section 2.20 mm
	Quantity 20 pieces



Item no.	Model
5000-066	Inner diameter 14.50 mm
	Cross-section 2.50 mm
	Quantity 20 pieces



Item no.	Model
5000-071	Inner diameter 8.00 mm
	Cross-section 1.80 mm
	Quantity 20 pieces



Item no.	Model
5000-067	Inner diameter 6.70 mm
	Cross-section 1.70 mm
	Quantity 20 pieces



Item no.	Model
5000-072	Inner diameter 8.80 mm
	Cross-section 1.90 mm
	Quantity 20 pieces



Item no.	Model
5000-068	Inner diameter 7.50 mm
	Cross-section 2.50 mm
	Quantity 20 pieces



Item no.	Model
5000-073	Inner diameter 10.00 mm
	Cross-section 2.00 mm
	Quantity 20 pieces



01

Assortment of universal valves

► Item no. 1957-500-4

Contents: 51 parts
 20 x Standard valve insert (art. no. 5000-106)
 1 x Small valve tool (art. no. 5000-121)
 5 x M8 PEUGEOT / VOLVO valve (art. no. 5000-122)
 5 x EATON 8 mm valve (art. no. 5000-123)
 5 x EATON 10 mm valve (art. no. 5000-124)
 5 x JRA HNBR valve (art. no. 5000-125)
 5 x RENAULT valve (art. no. 5000-126)
 5 x AUDI valve (art. no. 5000-127)



01

02

Assortment of universal O-rings

► Item no. 1957-500-1

Contents: 360 parts
 20 x 4.47 x 1.78 (art. no. 5000-003)
 20 x 6.02 x 2.62 (art. no. 5000-032)
 20 x 6.07 x 1.78 (art. no. 5000-007)
 20 x 6.70 x 1.70 (art. no. 5000-067)
 20 x 6.95 x 2.20 (art. no. 5000-070)
 20 x 7.50 x 2.50 (art. no. 5000-068)
 20 x 7.65 x 1.63 (art. no. 5000-012)
 20 x 7.65 x 1.78 (art. no. 5000-050)
 20 x 7.00 x 1.50 (art. no. 5000-069)
 20 x 8.00 x 1.80 (art. no. 5000-071)
 20 x 8.00 x 2.00 (art. no. 5000-004)
 20 x 8.80 x 1.90 (art. no. 5000-072)
 20 x 9.25 x 1.78 (art. no. 5000-016)
 20 x 9.25 x 2.39 (art. no. 5000-005)
 20 x 9.50 x 2.50 (art. no. 5000-060)
 20 x 10.12 x 1.85 (art. no. 5000-010)
 20 x 10.00 x 2.00 (art. no. 5000-073)
 20 x 10.00 x 2.50 (art. no. 5000-008)



02

03

Assortment of universal O-rings

► Item no. 1957-500-2

Contents: 360 parts
 20 x 10.77 X 2.62 (art. no. 5000-034)
 20 x 10.80 X 2.40 (art. no. 5000-009)
 20 x 10.80 X 2.40 (art. no. 5000-061)
 20 x 10.82 X 1.78 (art. no. 5000-017)
 20 x 11.50 X 2.50 (art. no. 5000-062)
 20 x 12.01 X 1.88 (art. no. 5000-047)
 20 x 12.37 X 2.62 (art. no. 5000-035)
 20 x 13.40 X 1.78 (art. no. 5000-063)
 20 x 13.80 X 2.40 (art. no. 5000-064)
 20 x 13.94 X 2.62 (art. no. 5000-036)
 20 x 14.00 X 1.78 (art. no. 5000-023)
 20 x 14.25 X 2.40 (art. no. 5000-065)
 20 x 14.30 X 2.30 (art. no. 5000-021)
 20 x 14.50 X 2.50 (art. no. 5000-066)
 20 x 15.47 X 3.53 (art. no. 5000-043)
 20 x 15.68 X 1.93 (art. no. 5000-026)
 20 x 17.17 X 1.78 (art. no. 5000-028)
 20 x 17.00 X 2.00 (art. no. 5000-029)



03

Cap

- ▶ Item no. 5000-100
- ▶ Low-pressure side blue, 13 mm VW standard, 6 pieces



Cap

- ▶ Item no. 5000-101
- ▶ High-pressure side Red, 16 mm Standard VW 6 pieces



Valve cap

- ▶ Item no. 5000-128
- ▶ High-pressure side M10 x 0.75 6 pieces



Valve cap

- ▶ Item no. 5000-129
- ▶ Low-pressure side M8 x 1 6 pieces



Ford Springlock

- ▶ Item no. 5000-114
- ▶ Tool 3/8" #148; red, no. 6 1 piece



Ford Springlock

- ▶ Item no. 5000-115
- ▶ Tool 1/2" #148; blue, no. 8 1 piece



Ford Springlock

- ▶ Item no. 5000-116
- ▶ Tool 5/8" #148; black, no. 10 1 piece



Ford Springlock

- ▶ Item no. 5000-117
- ▶ Tool 3/4" #148; white, no. 12 1 piece



Opel Springlock

- ▶ Item no. 5000-118
- ▶ Tool red 1 piece



Opel Springlock

- ▶ Item no. 5000-119
- ▶ Tool blue 1 piece



Valve

- ▶ Item no. 5000-122
- ▶ M8, Peugeot/Volvo, 5 pieces



Valve

- ▶ Item no. 5000-123
- ▶ 8 mm, Eaton, 5 pieces



Valve

- ▶ Item no. 5000-124
- ▶ 10 mm, Eaton, 5 pieces



Valve core

- ▶ Item no. 5000-106
- ▶ Standard, 20 pieces



adapter

- ▶ Item no. 5000-113
- ▶ R 134A, 16 mm, 1 piece



Valve

- ▶ Item no. 5000-125
- ▶ JRA HNBR, 5 pieces



Valve

- ▶ Item no. 5000-126
- ▶ Renault, 5 pieces



Valve

- ▶ Item no. 5000-127
- ▶ Audi 5 pieces



Eaton SSV

- ▶ Item no. 5000-120
- ▶ Valve tool large, 1 piece



JRA standard

- ▶ Item no. 5000-121
- ▶ Valve tool small, 1 piece



Car light bulbs



H7

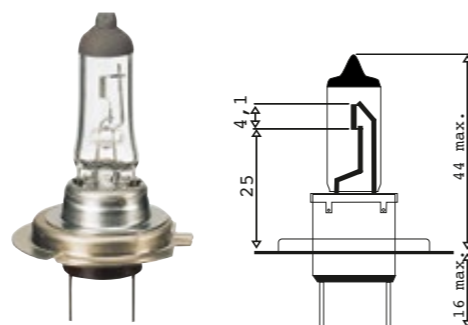

Item no.	Implementation	Base
3720-064-209	12V H7 55W Long-Life	Px26d
3720-064-252	12V Vision Plus +50%	Px26d
3720-064-265	12V H7 Set +90%	Px26d
3720-064-210	12V Osram Ultra Life	Px26d

Item no.	Implementation	Base
3723-064-201	12V H7 55W	Px26d
3723-064-209	12V H7 55W Long-Life	Px26d

NORM LIGHT

H1



Item no.	Implementation	Base
3720-064-250	12V H1 55W, Vision Plus +50%	14.5s
3720-064-150	12V H1 55W	14.5s
3720-064-221	12V H1 55W, Premium +30%	14.5s
3720-064-202	12V H1 55W Spot	14.5s

Item no.	Implementation	Base
3723-064-150	12V H1 55W	14.5s

NORM LIGHT

H4

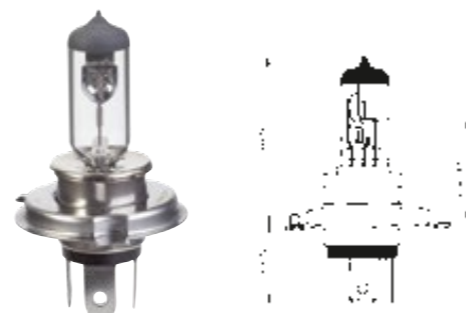

Item no.	Implementation	Base
3720-064-264	12V H4 set, +90%	P43t
3720-064-251	12V H4 60/55W, Vision Plus +50%	P43t
3720-064-193	12V H4 60/55W	P43t
3720-064-220	12V H4 60/55W, Premium +30%	P43t

Item no.	Implementation	Base
3723-064-193	12V H4 60/55W	P43t

NORM LIGHT

H3



Item no.	Implementation	Base
3720-064-156	12V H3 55W	PK22s

Item no.	Implementation	Base
3723-064-156	12V H3 55W	PK22s

NORM LIGHT

H8

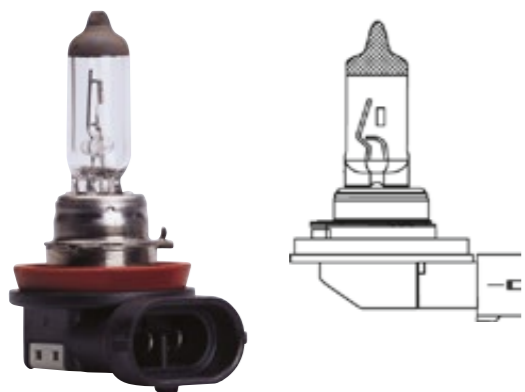

Item no.	Implementation	Base
3720-064-228	12V H8 35W	PGJ19-1

H9

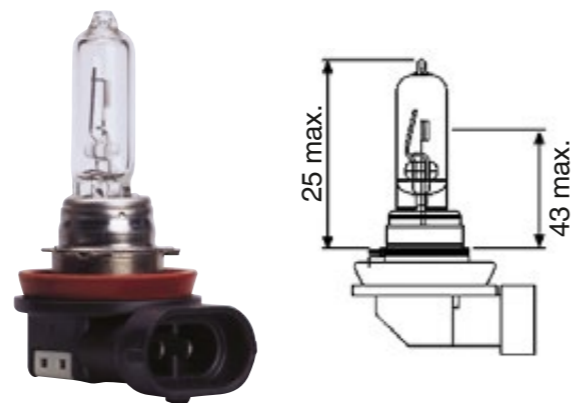

Item no.	Implementation	Base
3720-064-229	12V H9 65W	PGJ19-5

Duolux

► Product description
- Symmetrical



Item no.	Implementation	Base
3720-073-27	12V 35/35W	BA20d

Duolux

► Product description
- asymmetrical



Item no.	Implementation	Base
3720-079-51	12V 45/40W	P45t

H11

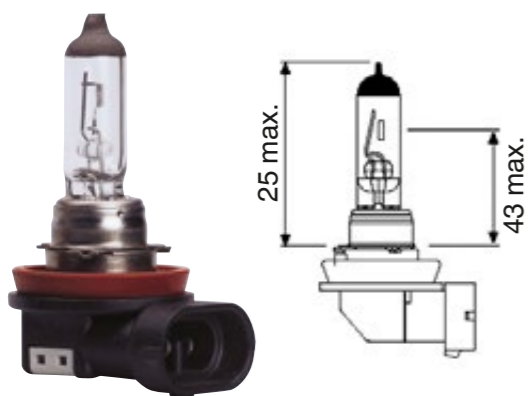

Item no.	Implementation	Base
3720-064-206	12V H11 55W	PGJ19-2

HIR2



Item no.	Implementation	Base
3720-064-216	12V HIR2 55W	Px22d

Halogen lamp

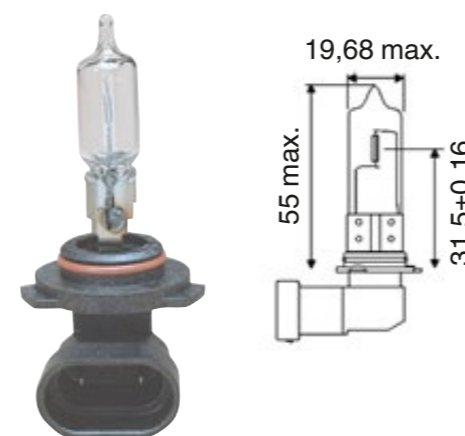

Item no.	Implementation	Base
3720-064-204	12V 60W HB3	P20d

Halogen lamp

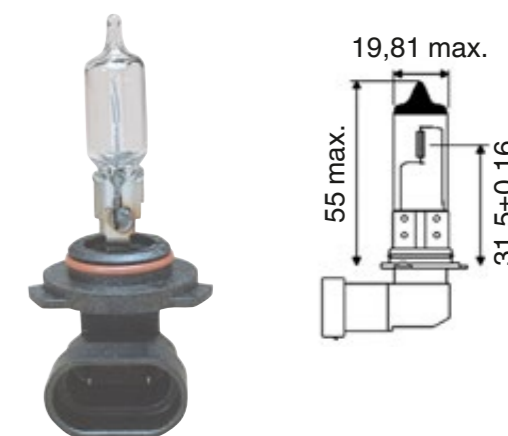

Item no.	Implementation	Base
3720-064-205	12V 51W HB4	P22d

01

Gas discharge headlight bulb D2S
XENON

► Item no. 3720-064-222

- Product description
- For projector headlights
 - Approx. 4,100 Kelvin
 - Voltage: 12 to 85
 - Base: D2S
 - Wattage: 35

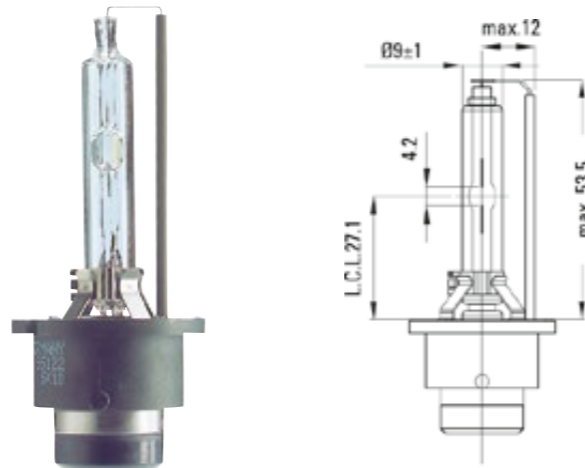

02

Gas discharge headlight bulb D2R
XENON

► Item no. 3720-064-223

- Product description
- For reflector headlights
 - Approx. 4,000 Kelvin
 - Voltage: 12 to 85
 - Base: D2R
 - Wattage: 35

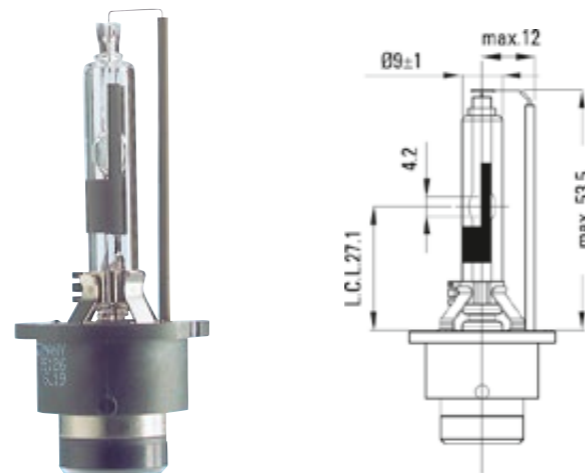

03

Gas discharge headlight bulb D1S
XENON

► Item no. 3720-064-224

- Product description
- Approx. 4,000 Kelvin
 - Base: D1S
 - Wattage: 35

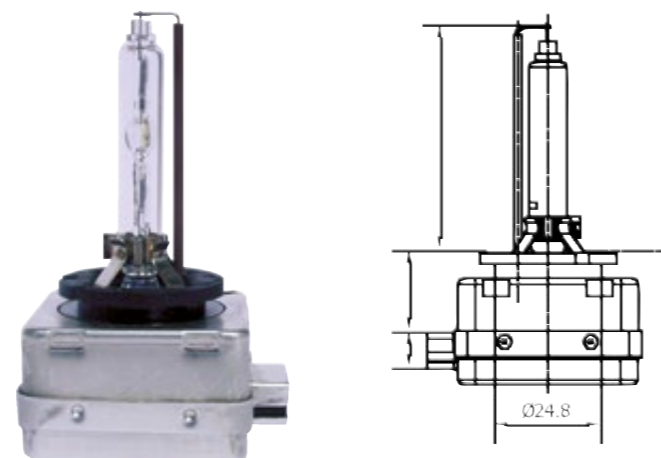

04

Electric discharge lamp

- Product description
- No mercury
 - Nominal voltage 42 Volt

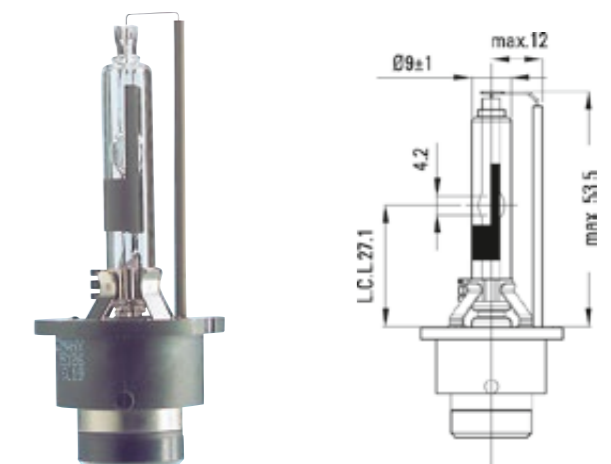

Item no.	Implementation	Base
3720-064-225	D3S 35W 3200 Lumen	PK32d-5
3720-064-226	D4S 35W 3200 Lumen	P32d-5
3720-064-227	D4R 35W 2800 Lumen	P32d-6

BA15s base

- ▶ Item no. 3720-075-27
- ▶ 18W

- ▶ Item no. 3720-075-06
- ▶ 21W

- ▶ Item no. 3723-075-06
- ▶ 21W Normlight

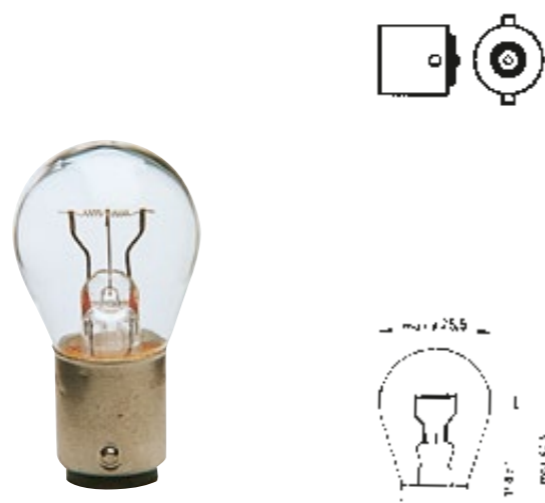

BA15s base

21 W, for special applications

- ▶ Item no. 3720-075-05



BA15s base

5 W

- ▶ Item no. 3720-054-07

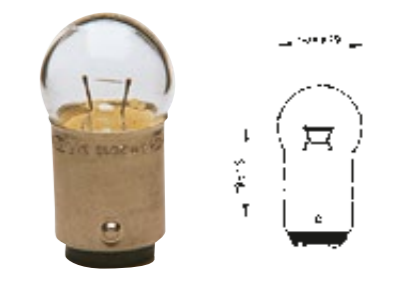

BA15s base

- ▶ Item no. 3720-050-07
- ▶ 5W

- ▶ Item no. 3720-050-08
- ▶ 10W

- ▶ Item no. 3723-050-07
- ▶ 5W Normlight

- ▶ Item no. 3723-050-08
- ▶ 10W Normlight



BAW15s base red Ford

- ▶ Item no. 3720-075-09
- ▶ 21W

- ▶ Item no. 3720-075-091
- ▶ 21/5W

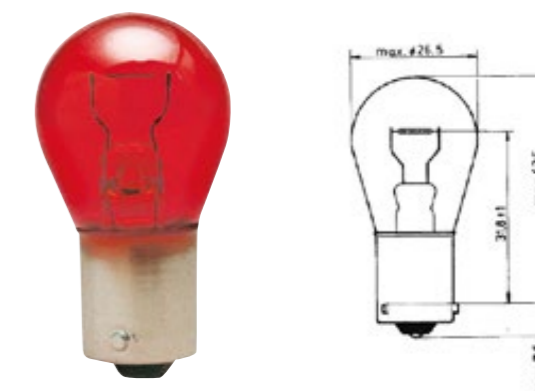

BAY15d base

21/5 W

- ▶ Item no. 3720-075-28
- ▶ 21/5W

- ▶ Item no. 3723-075-28
- ▶ 21/5W Normlight

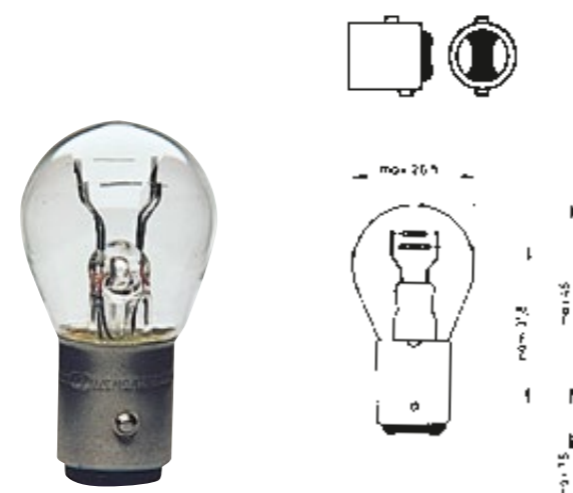

BAU15s base

- ▶ Item no. 3720-075-07
- ▶ 21W

- ▶ Item no. 3723-075-07
- ▶ amber (yellow) 21W Normlight

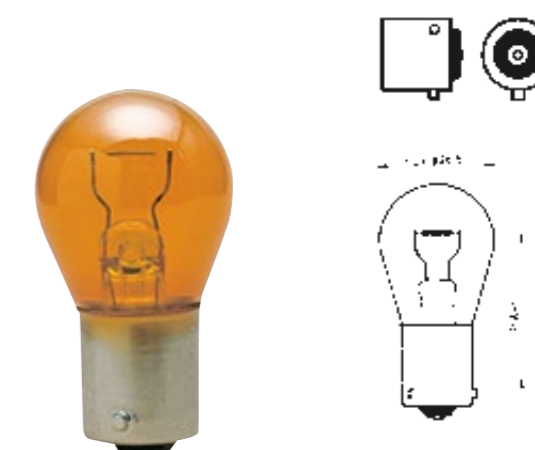

BAU 15s Silver Vision base

Glass colour silver, light colour yellow
21W, ideal for clear-glass indicators

- ▶ Item no. 3720-075-070

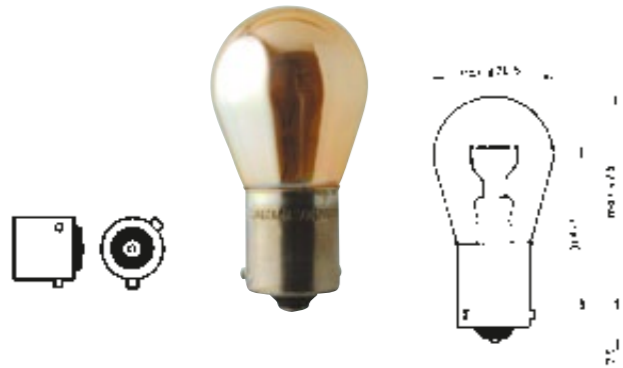

BAZ15d base

21/4 W

- ▶ Item no. 3720-075-08



BA9s Halogen base

- ▶ Item no. 3720-064-190
- ▶ 5W
- ▶ Item no. 3720-064-191
- ▶ 10W
- ▶ Item no. 3720-064-192
- ▶ 20W

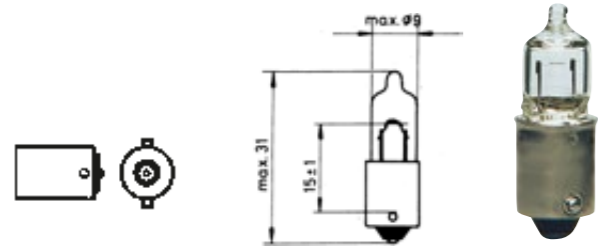

BAX9s Halogen base

Suitable for Audi/VW, BMW, Alfa Romeo, Mercedes Benz

- ▶ Item no. 3720-064-132
- ▶ 6W
- ▶ Item no. 3720-064-133
- ▶ 21W

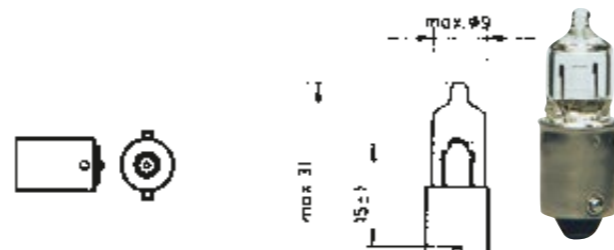

BA9s base

- ▶ Item no. 3720-038-93
- ▶ 4W
- ▶ Item no. 3720-038-94
- ▶ 3W
- ▶ Item no. 3720-037-96
- ▶ 2W

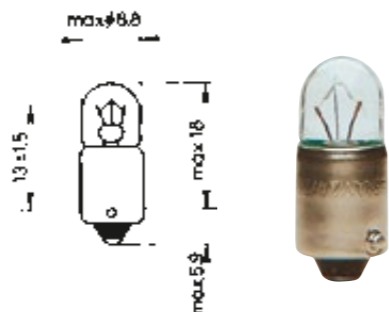

W3x16d base

21 W

- ▶ Item no. 3720-074-1
- ▶ 21W
- ▶ Item no. 3720-074-2
- ▶ 21/5W
- ▶ Item no. 3720-074-3
- ▶ 21W amber (yellow)



W2,1x9:5d base

16 W

- ▶ Item no. 3720-028-30



Halogen pin bulb

- ▶ Item no. 3720-072-30
- ▶ 20W, G 4



W2x4.6d base

- ▶ Item no. 3720-027-21
- ▶ 1.2W
- ▶ Item no. 3720-016-03
- ▶ 1.2W matt
- ▶ Item no. 3720-027-22
- ▶ 2W
- ▶ Item no. 3720-027-23
- ▶ 1.7W
- ▶ Item no. 3723-027-21
- ▶ 1.2W Normlight



W2,1x9:5d base

- ▶ Item no. 3720-028-20
- ▶ 2W
- ▶ Item no. 3720-028-21
- ▶ 3W
- ▶ Item no. 3720-028-24
- ▶ 5 W, amber
- ▶ Item no. 3720-028-25
- ▶ 5W
- ▶ Item no. 3720-028-26
- ▶ 5W, blue
- ▶ Item no. 3723-028-25
- ▶ 5W Normlight



Tubular lamp 8.5x8

35 mm

- ▶ Item no. 3720-064-18
- ▶ 5W

- ▶ Item no. 3720-064-19
- ▶ 10W

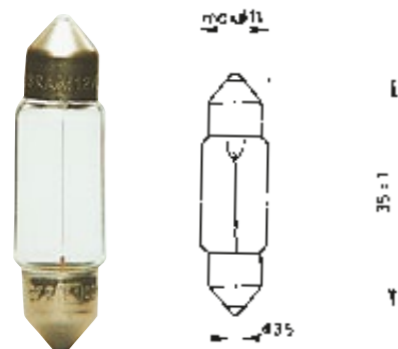

Festoon 8.5x8 Normlight

35 mm

- ▶ Item no. 3723-064-18
- ▶ 5W, Normlight

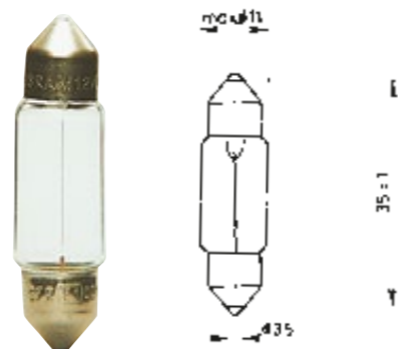

Tubular lamp 8.5x8

41 mm

- ▶ Item no. 3720-064-13
- ▶ 5W

- ▶ Item no. 3720-064-11
- ▶ 10W

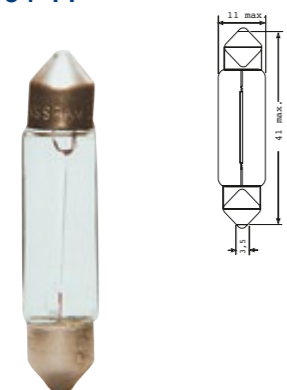

Festoon 8-8.5

41 mm

- ▶ Item no. 3720-064-75
- ▶ 18W

- ▶ Item no. 3720-064-76
- ▶ 21W

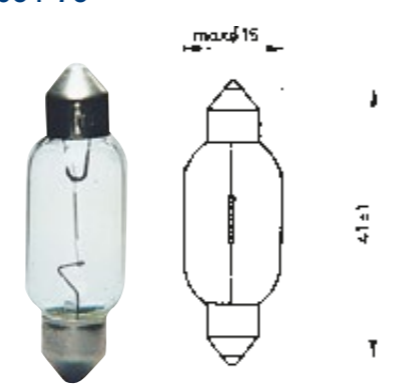

Tubular lamp 8.5x8

28 mm

- ▶ Item no. 3720-064-111
- ▶ 10W



Tubular lamp 6-7.5

28 mm

- ▶ Item no. 3720-064-28
- ▶ 3W



B8,4d

- ▶ Item no. 3720-027-401
- ▶ 1.2W black

- ▶ Item no. 3720-027-400
- ▶ 2.0W turquoise

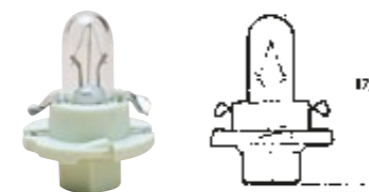

B10d

- ▶ Item no. 3720-064-188
- ▶ 3W Halogen



B8,5d

- ▶ Item no. 3720-027-402
- ▶ 2.0W green

- ▶ Item no. 3720-027-403
- ▶ 1.2W black



B8,3d

- ▶ Item no. 3720-027-405
- ▶ 1.2W black

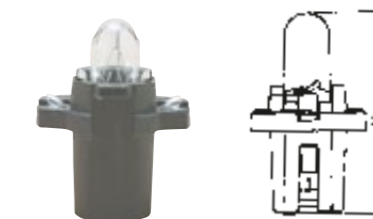

W2x4,6d

- ▶ Item no. 3720-027-500
- ▶ 0.5W grey

- ▶ Item no. 3720-027-501
- ▶ 1.2W white

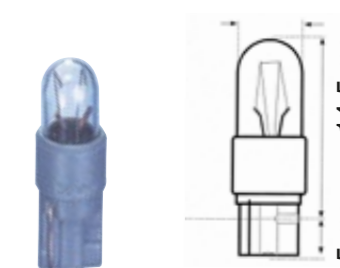

B8,7d

- ▶ Item no. 3720-027-409
- ▶ 1.2W grey

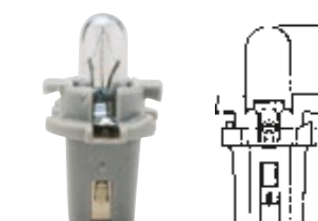

01

PCV bulb box H4

- ▶ Item no. 3720-02
- ▶ Contents: 9 pieces

▶ Product description

The 9-piece PCV spare bulb set comes in a handy and robust plastic box.

Item no.	Description	Quantity
3731-007-5	Blade fuse 7.5 A	1
3731-010	Blade fuse 10 A	1
3731-015	Blade fuse 15 A	1
3720-028-25	Glass base bulb 5W	1
3720-038-93	Parking light bulb 4W	1
3720-075-28	Brake light bulb 21/5W	1
3720-075-06	Indicator light bulb 2V 5W	1
3720-064-18	Number plate light 2V 5W	1
3720-064-193	H4 60/55W	1



01

02

PCV bulb box H7/H1

- ▶ Item no. 3720-020
- ▶ Contents: 11 pieces

▶ Product description

The 11-piece PCV spare bulb set comes in a handy and robust plastic box.

Item no.	Description	Quantity
3731-007-5	Blade fuse 7.5 A	1
3731-010	Blade fuse 10 A	1
3731-015	Blade fuse 15 A	1
3720-028-25	Glass base bulb 5W	1
3720-038-93	Parking light bulb 4W	1
3720-075-28	Brake light bulb 21/5W	1
3720-075-06	Indicator light bulb 2V 5W	1
3720-064-18	Number plate light 2V 5W	1
3720-075-07	Pilot bulb, yellow, 21W	1
3720-064-150	H1 55W	1



02

03

PCV bulb box H4 Normlight

- ▶ Item no. 3723-02
- ▶ Contents: 9 pieces

▶ Product description

The 9-piece PCV spare bulb set comes in a handy and robust plastic box.

Item no.	Description	Quantity
3731-007-5	Blade fuse 7.5 A	1
3731-010	Blade fuse 10 A	1
3731-015	Blade fuse 15 A	1
3723-028-25	Glass base bulb 5W	1
3720-038-93	Parking light bulb 4W	1
3723-075-28	Brake and tail light bulb, 21/5W	1
3723-075-06	Indicator and brake light bulb, 21W	1
3723-064-193	H4 60/55W	1
3723-064-18	Festoon bulb, 5W	1



03

04

PCV bulb box H7/H1 Normlight

- ▶ Item no. 3723-020
- ▶ Contents: 11 pieces

▶ Product description

The 11-piece PCV spare bulb set comes in a handy and robust plastic box.

Item no.	Description	Quantity
3731-007-5	Blade fuse 7.5 A	1
3731-010	Blade fuse 10 A	1
3731-015	Blade fuse 15 A	1
3723-028-25	Glass base bulb 5W	1
3720-038-93	Parking light bulb 4W	1
3723-075-28	Brake and tail light bulb, 21/5W	1
3723-075-06	Indicator and brake light bulb, 21W	1
3723-064-18	Festoon bulb, 5W	1
3723-075-07	Pilot bulb, yellow, 21W	1
3723-064-201	H7 12V 55W	1
3723-064-150	H1 12V 55W	1



04

01

Box for bulb cabinet Normlight 12V▶ **Item no. 3720-555-12**▶ **Product description**

The bulb cabinet is made from very sturdy and high-quality cardboard, delivered fully assembled and fitted with 12 Volt Normlight bulbs.

Consists of the following 390 components

Dimensions (cabinet): 510x422x178mm

Contents:

- 40 x 3723-050-08 Tail light bulb 12V / 10W
- 40 x 3723-028-25 Wedge base bulb 12V / 5W
- 40 x 3723-027-21 Wedge base bulb 12V / 1.2W
- 30 x 3723-064-18 Festoon bulb 12V / 5W
- 50 x 3723-075-06 Indicator & brake light 12V / 21W
- 50 x 3723-075-28 Brake and tail light bulb 12V / 21/5W
- 40 x 3723-075-07 Pilot bulb 12V / 21W
- 10 x 3723-064-193 H4 12V / 60 / 55W
- 50 x 3723-050-07 Tail light bulb 12V / 5W
- 20 x 3723-064-201 H7 12V / 55W
- 20 x 3723-064-209 H7 long-life 12V / 55W



01



H7

- Up to 100% more light on the road
- Up to 100% longer life (LL)



Item no.	Implementation	Base
3720-064-274	24V H7 70W HD LL, Osram Truckstar Pro	Px26d

H1

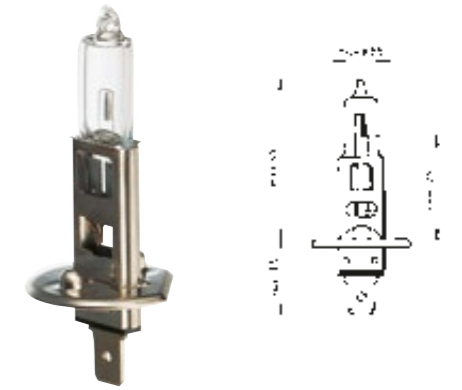

Item no.	Implementation	Base
3720-064-270	24V H1 70W HD LL	P14.5s

Item no.	Implementation	Base
3723-064-155	24V H1 70W	P14.5s

NORM LIGHT

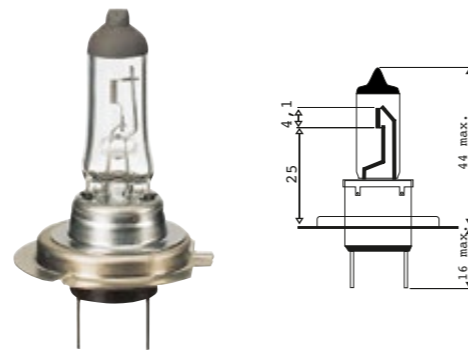

Item no.	Implementation	Base
3720-064-273	24V H7 70W HD LL	Px26d

Item no.	Implementation	Base
3723-064-211	24V H7 70W	Px26d

NORM LIGHT

H3

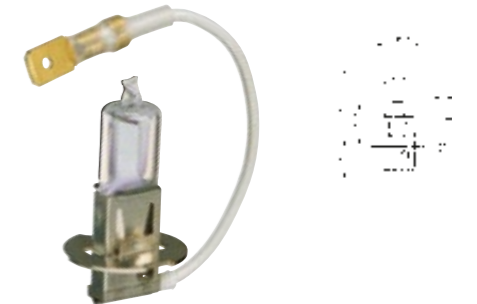

Item no.	Implementation	Base
3720-064-271	24V H3 70W HD LL	PK22s

Item no.	Implementation	Base
3723-064-151	24V H3 70W	PK22s

NORM LIGHT

H4



Item no.	Implementation	Base
3720-064-272	24V H4 70/75W HD LL	P43t

Item no.	Implementation	Base
3723-064-196	24V H4 70/75W	P43t
3723-064-197	24V H4 70/75W HD	P43t

NORM LIGHT

HD = VIBRATION RESISTANT

LL = LONG LIFE

01

Gas discharge headlight bulb D2S
XENON

► Item no. 3720-064-222

- Product description
- For projector headlights
- Approx. 4,100 Kelvin
- Voltage: 12 to 85
- Base: D2S
- Wattage: 35

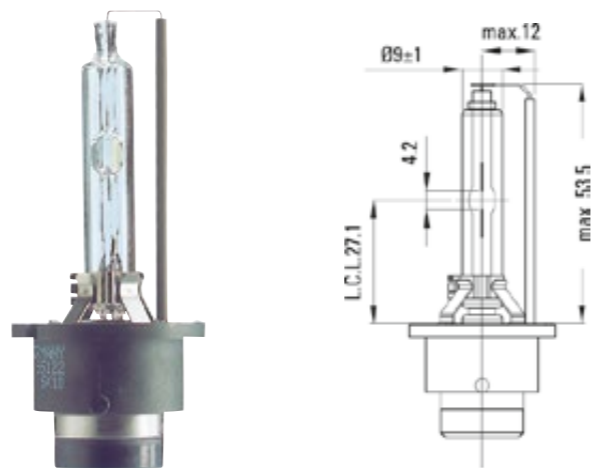

02

Gas discharge headlight bulb D2R
XENON

► Item no. 3720-064-223

- Product description
- For reflector headlights
- Approx. 4,000 Kelvin
- Voltage: 12 to 85
- Base: D2R
- Wattage: 35

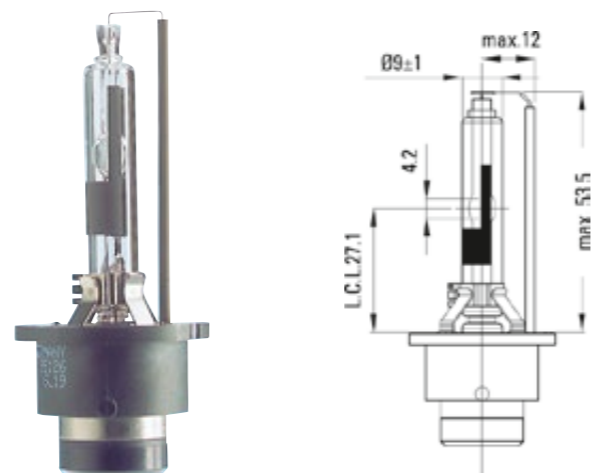

03

Gas discharge headlight bulb D1S
XENON

► Item no. 3720-064-224

- Product description
- Approx. 4,000 Kelvin
- Base: D1S
- Wattage: 35

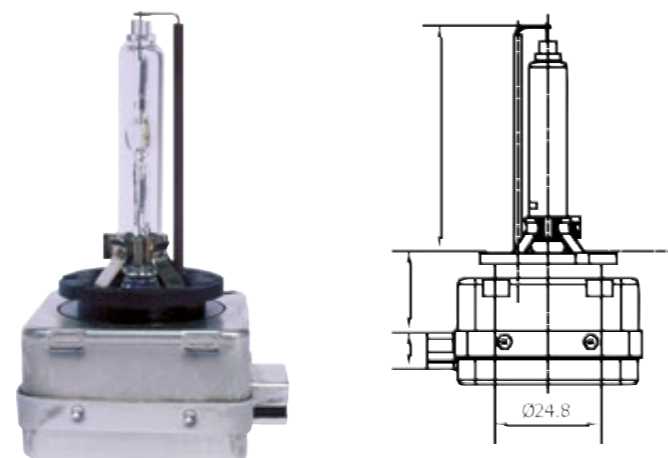

04

Electric discharge lamp

- Product description
- No mercury
- Nominal voltage 42 Volt

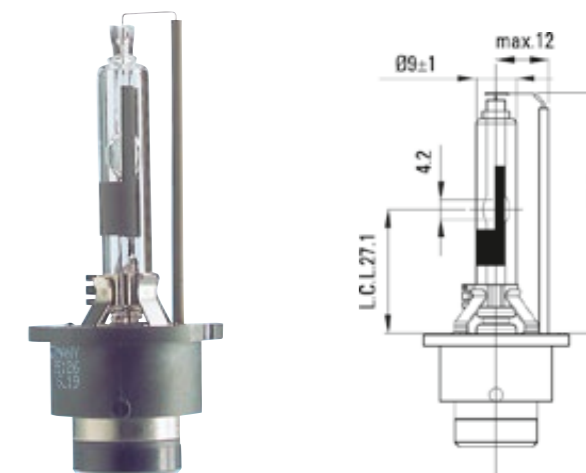

Item no.	Implementation	Base
3720-064-225	D3S 35W 3200 Lumen	PK32d-5
3720-064-226	D4S 35W 3200 Lumen	P32d-5
3720-064-227	D4R 35W 2800 Lumen	P32d-6

BA15s base

- ▶ Item no. 3720-075-35
- ▶ 18W

- ▶ Item no. 3720-075-11
- ▶ 21W

- ▶ Item no. 3720-752-1
- ▶ 21W HD LL

- ▶ Item no. 3723-075-11
- ▶ 21W Normlight

- ▶ Item no. 3723-751-1
- ▶ 21W HD Normlight

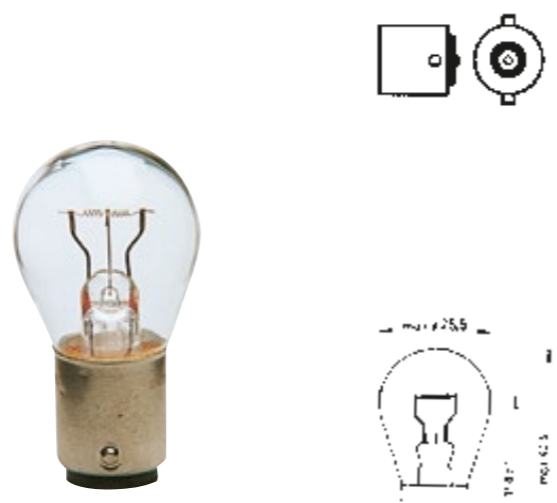

BAY15d base

- ▶ Item no. 3720-075-37
- ▶ 21/5W

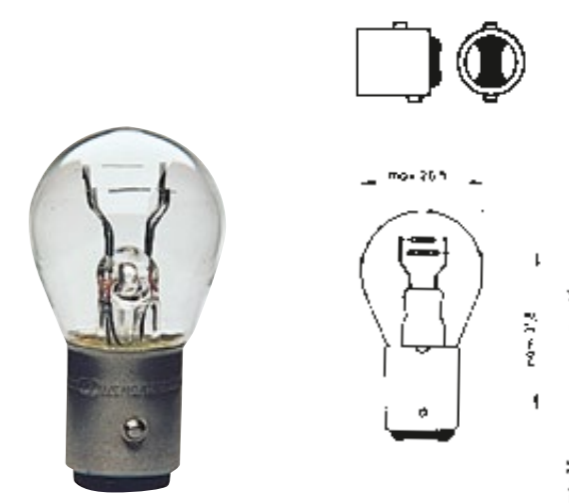

BA15s base

- ▶ Item no. 3720-056-27
- ▶ 5W

- ▶ Item no. 3720-752-3
- ▶ 5W HD LL

- ▶ Item no. 3720-056-37
- ▶ 10W

- ▶ Item no. 3720-752-5
- ▶ 10W HD LL

- ▶ Item no. 3723-562-7
- ▶ 5W HD Normlight

- ▶ Item no. 3723-563-7
- ▶ 10W HD Normlight

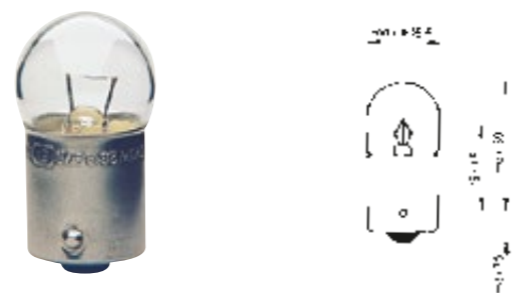

BAZ15D base

- ▶ Item no. 3720-075-47
- ▶ 21/4W



BA15s base

- ▶ Item no. 3720-056-26
- ▶ 5W

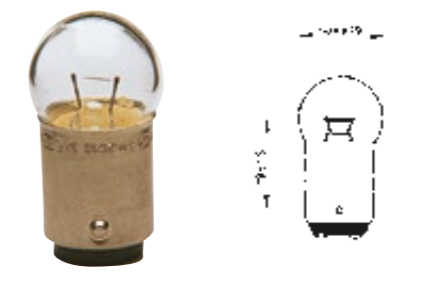

BAU15s base

- ▶ Item no. 3720-752-2
- ▶ 21W HD LL amber (yellow)



HD = VIBRATION RESISTANT
LL = LONG LIFE



BAY15d base Normlight

- ▶ Item no. 3723-075-37
- ▶ 21/5W

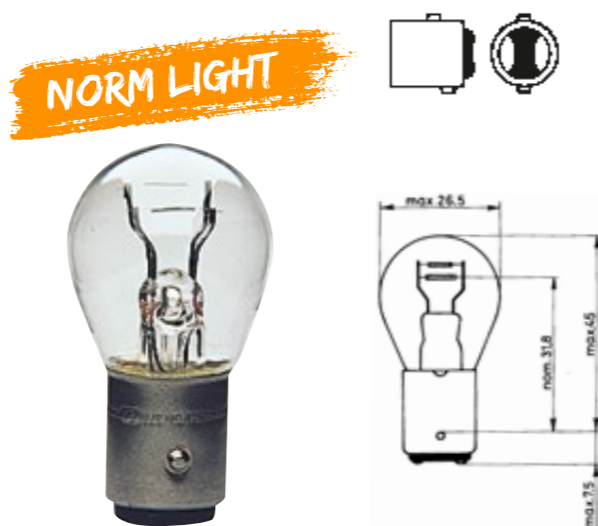

BA7s base

- ▶ Item no. 3720-038-99
- ▶ 3W

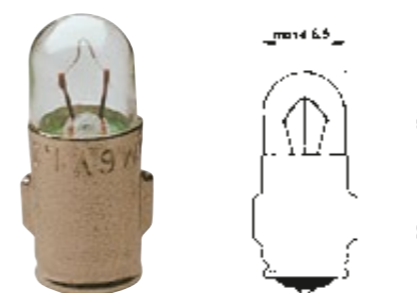

BAY9s base

- ▶ Item no. 3720-075-13
- ▶ 21W Halogen

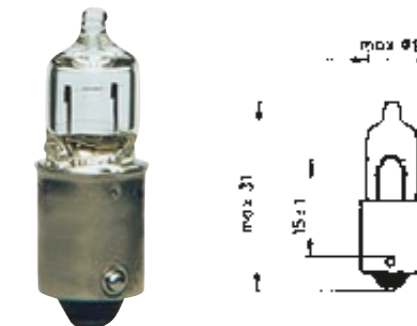

BA9s base

- ▶ Item no. 3720-039-30
- ▶ 4W
- ▶ Item no. 3720-752-6
- ▶ 4W HD LL
- ▶ Item no. 3720-037-97
- ▶ 2W

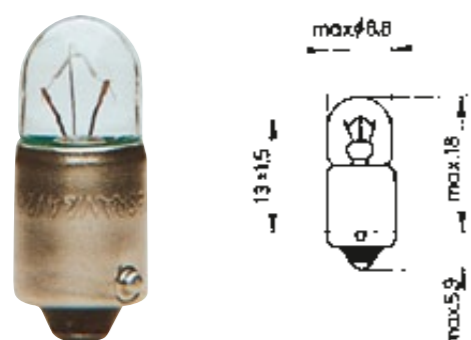

BA9s base

- ▶ Item no. 3723-393-0
- ▶ 4W HD



W2x4.6d base

- ▶ Item no. 3720-027-41
- ▶ 1.2W

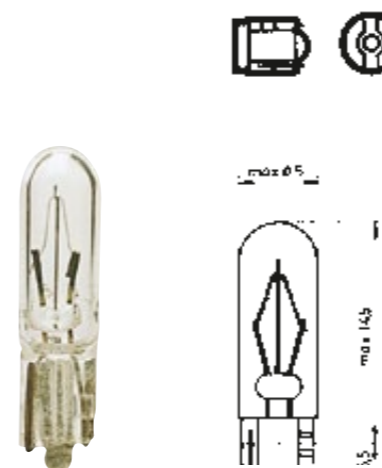

- ▶ W2,1x9:5d base Item no. 3720-028-40
- ▶ 2W
- ▶ Item no. 3720-028-41
- ▶ 3W
- ▶ Item no. 3720-028-45
- ▶ 5W

- ▶ Item no. 3723-028-45
- ▶ 5W Normlight

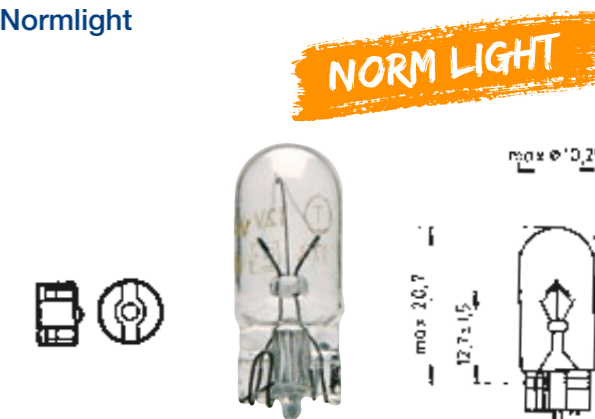

Soffitte 8, 5-8

41 mm

Item no.	Implementation
3720-064-24	5W
3720-064-29	10W

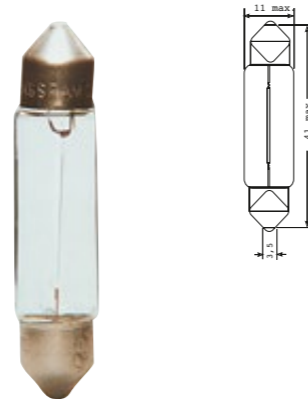

Soffitte 8, 5-8

35 mm

Item no.	Implementation
3720-064-23	5W

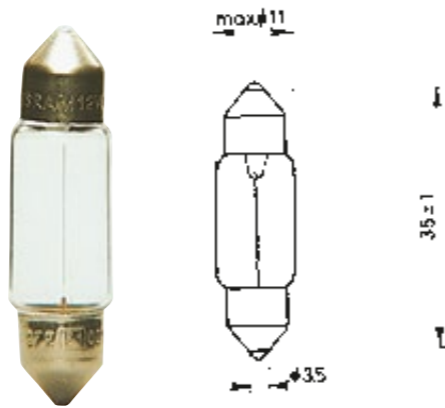

Soffitte 8, 5-8

41 mm

Item no.	Implementation
3720-064-80	18W

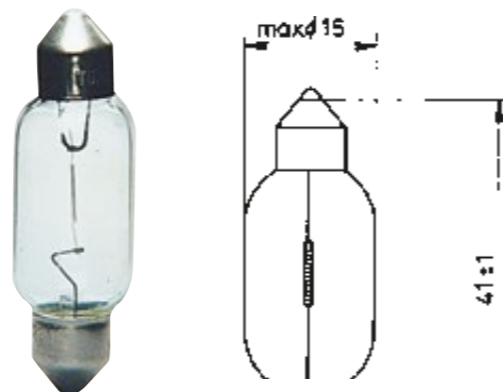

B8,3d

- ▶ Item no. 3720-027-404
- ▶ 1.2W grey

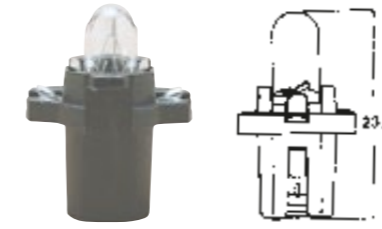

B9

- ▶ Item no. 3720-027-603
- ▶ 2.4W white

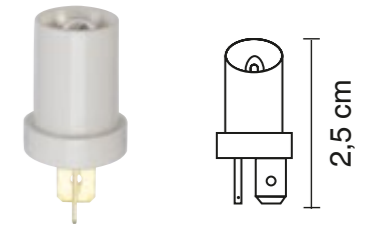

EBS R11

- ▶ Item no. 3720-027-420
- ▶ 1.2 W green suitable for Volvo

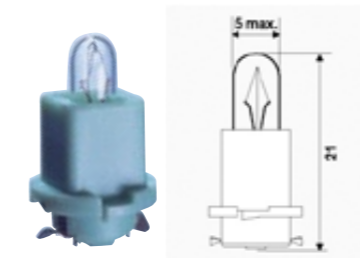

EBS R4

- ▶ Item no. 3720-027-605
- ▶ 1.2W, yellow

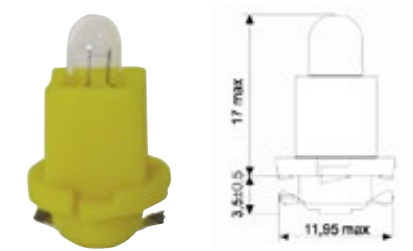

B8,5d

- ▶ Item no. 3720-027-419
- ▶ 1.2W, grey, suitable for tachographs

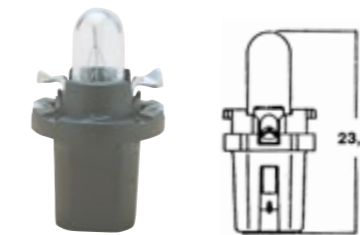

Bx8,5d

- ▶ Item no. 3720-027-600
- ▶ 1.2W, brown

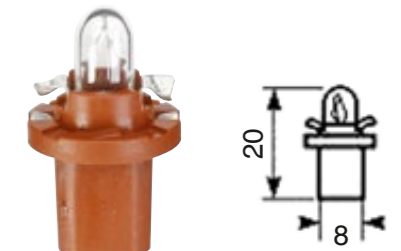

KW2x4,6D

- ▶ Item no. 3720-027-606
- ▶ 1W white

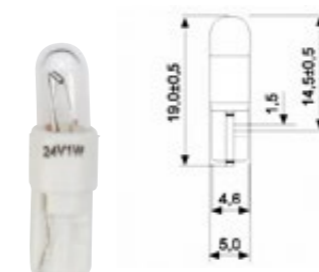



01

Empty bulb box with foam insert for H1 and H7

► Item no. 3720-03-222

► Product description

Replacement bulb box for 24 V and 12 V lights
With liner for H7 and H1 bulbs and additional
places for fuses and tail-light bulbs.



01

02

Box for replacement HGV bulbs 24 V H7/H1

► Item no. 3723-030
► Contents: 22 pieces

► Product description

Contents:

1 x 3723-064-155 Main headlight H1
1 x 3723-064-211 Main headlight H7
2 x 3723-393-0 Parking light 4 W HD
2 x 3723-563-7 Tail light 10 W HD
6 x 3723-075-11 Indicator and brake light 21 W
2 x 3720-064-29 Festoon 8.5-8 10 W
2 x 3731-010 Fuse 10 A
2 x 3731-015 Fuse 15 A
2 x 3731-020 Fuse 20 A
2 x 3731-025 Fuse 25 A



02

03

Glowpoint LED

With shatter-proof casing

► Item no. 3720-075-15

► Product description

- Voltage: 24
- Base: BA15s
- Wattage: 1 W
- Long service life: up to 10,000 operating hours
- Safety: is increased due to high luminance
- Saves energy and costs

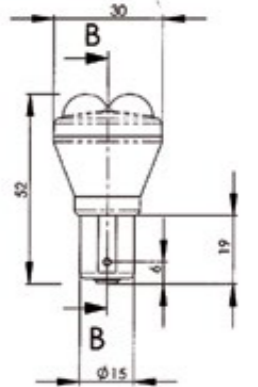

03

Auto electrics



Cable connectors with heat-shrinkable tubing insulation

100% waterproof

► **Product description**

- Min. shrinkage temperature: 100°C
- Continuous temperature range: -55°C to +125°C
- Shrinkage ratio: 3:1 / Material: Polyolefin
- Polyolefin shrinks 40% faster than polyamide
- Shrinkage temperature lower than for polyamides (100°C instead of 170°C)
- * VW special plug

0,1 - 0,5 mm²



3555-516-0

0,5 - 1,5 mm²



3555-516-1

1,5 - 2,5 mm²



3555-516-2

4,0 - 6,0 mm²



3555-516-4

***0,5 mm²**



3555-516-5

Solder butt connector

Soldering, shrinking, waterproof connection in just one work step!

► **Product description**

- Continuous temperature resistance: -55°C up to +125°C
- Melting point above 85°C

3555-923-0



Ø 0.3 - 0.8

Length: 26 mm

3555-923-1



Ø 0.8 - 2.0

Length: 42 mm

3555-923-3



Ø 4.0 - 6.0

Length: 42 mm

3555-923-2



Ø 2.0 - 4.0

Length: 42 mm

0.5 - 1.0 mm²

3555-901-1
M4



3555-902-1
M5



3555-903-1
M6



3555-904-1
M8



3555-904-11
M10



3555-905-1
6,3



3555-944-1
6,3



1.5 - 2.5 mm²

3555-908-2
M4



3555-909-2
M5



3555-910-2
M6



3555-911-2
M8



3555-912-2
M10



3555-905-2
6,3



3555-945-2
6,3



4.0 - 6.0 mm²

3555-914-4
M4



3555-915-4
M5























3555-916-4
M6



3555-917-4
M8





0.5 - 1.0 mm²

		
3558-900-1 M3	3558-901-1 M4	3558-902-1 M5
		
3558-903-1 M6	3558-904-1 M8	3558-960-1 2,8
		
3558-960 2,8	3558-976-1 4,8	3558-977-1 4,8
		
3558-905-1 6,3	3558-975-1 2,8	3558-939-1 4,8
		
3558-944-1 6,3	3558-905-11 6,3	3558-925-1
		
3558-946-1 M4	3558-947-1 M4	3558-942-1 6,3
		
3558-950-1	3558-955-1 M4	3558-954-1 M5

1.5 - 2.5 mm²

		
3558-907-2 M3,5	3558-908-2 M4	3558-909-2 M5
		
3558-910-2 M6		
		
3558-976-2 4,8	3558-905-2 6,3	3558-940-2 7,7
		
3558-945-2 6,3	3558-939-2 4,8	
		
3558-905-22 6,3	3558-926-2	
		
3558-948-2 M5	3558-949-2 M5	3558-943-2 6,3
		
3558-951-2	3558-953-2 M4	3558-954-2 M5

4.0 - 6.0 mm²

		
3558-914-4 M4	3558-915-4 M5	3558-916-4 M6
		
3558-917-4 M8	3558-918-4 M10	3558-905-4 6,3
		
3558-941-4 9,5	3558-927-4	3558-961 M5
		
3558-962 M5	3558-952-4	3558-921-4 M4
		
3558-906-4 6,3		

01**Assortment of cable connectors**
waterproof

► Item no. 1957-555

Contents: 400 parts

50 x Heat-shrink connectors red 0.5-1.5 (art. no. 3555-516-1)
 50 x Heat-shrink connectors blue 1.5-2.5 (art. no. 3555-516-2)
 25 x Heat-shrink connectors yellow 4.0-6.0 (art. no. 3555-516-4)
 25 x Ring tongues M6 red with shrink hose (art. no. 3555-903-1)
 25 x Ring tongues M8 red with shrink hose (art. no. 3555-904-1)
 25 x Ring tongues M5 blue with shrink hose (art. no. 3555-909-2)
 25 x Ring tongues M8 blue with shrink hose (art. no. 3555-911-2)
 50 x Butt connector solderable red 0.5-1.5 (art. no. 3555-923-1)
 50 x Butt connector solderable blue 1.5-2.5 (art. no. 3555-923-2)
 25 x Butt connector solderable yellow 3.0-6.0 (art. no. 3555-923-3)
 25 x Push-on male connector blue with shrink hose (art. no. 3555-945-2)
 25 x Push-on female connector blue with shrink hose (art. no. 3555-905-2)



01

02**Assortment of cable connectors**
Insulated

► Item no. 1957-558-1

Contents: 530 parts

20 x Cable quick connector blue (art. no. 3555-564)
 25 x Ring tongue M4 red (art. no. 3558-901-1)
 50 x Push-on female connector red (art. no. 3558-905-1)
 100 x Push-on female connector blue (art. no. 3558-905-2)
 50 x Push-on female connector yellow (art. no. 3558-905-4)
 25 x Ring tongue M4 blue (art. no. 3558-908-2)
 25 x Ring tongue M5 blue (art. no. 3558-909-2)
 25 x Ring tongue M6 blue (art. no. 3558-910-2)
 25 x Ring tongue M6 yellow (art. no. 3558-916-4)
 25 x Butt connector red (art. no. 3558-925-1)
 25 x Butt connector blue (art. no. 3558-926-2)
 25 x Double plug connector blue (art. no. 3558-943-2)
 25 x Push-on male connector 6.3mm red (art. no. 3558-944-1)
 25 x Push-on male connector 6.3mm blue (art. no. 3558-945-2)
 15 x Round male connector red (art. no. 3558-946-1)
 15 x Round female connector red (art. no. 3558-947-1)
 15 x Round male connector blue (art. no. 3558-948-2)
 15 x Round female connector blue (art. no. 3558-949-2)



02

Cable quick connectors



3555-951
0.25 – 1.0 mm²



3555-951-1
0.25 – 1.0 mm²



3555-952
1.0 – 2.5 mm²



3555-952-1
1.0 – 2.5 mm²



3555-953
4.0 – 6.0 mm²



3555-953-1
4.0 – 6.0 mm²

Cable quick connectors



3555-557
0.4 – 1.0 mm²



3555-557-1
0.2 – 1.5 mm²



3555-564-1
1.5–2.5 mm²



3555-564
1.0 – 2.5 mm²



3555-562-1
1.5–4.0 mm²



















3555-562
2.5–4.0 mm²



Blade receptacles

universal

3558-631-2	4.8 x 0.8	1.5 – 2.5 with notch	MBL	
3558-531-2	4.8 x 0.8	1.50 – 2.5 pre-rolled	MVZ	
3558-504-0	6.3 x 0.8	0.50 – 1.0 with notch pre-rolled	MBL	
3558-991-6	6.3 x 0.8	0.50 – 1.0 with notch pre-rolled	MVZ	
3558-603-2	6.3 x 0.8	1.50 – 2.5 with notch pre-rolled	MBL	
3558-929	6.3 x 0.8	1.50 – 2.5 pre-rolled	MBL	
3558-991-7	6.3 x 0.8	1.50 – 2.5 with notch pre-rolled	MVZ	
3558-992-8	6.3 x 0.8	1.5 – 2.0 with notch pre-rolled	MSI	
3558-504-7	6.3 x 0.8	4.0 – 6.0 with notch pre-rolled	MBL	
3558-996-2	6.3 x 0.8	4.0 – 6.0 with notch pre-rolled	MVZ	
3558-992-6	6.3 x 0.8	4.0 – 6.0 with notch pre-rolled	MSI	
3558-502-0	7.7 x 0.8	2.0 x 1.0 with notch	MBL	
3558-526-6	9.5 x 1.2	4,0 - 6,0	MBL	
3558-526-7	9.5 x 1.2	4.0 – 6.0 with notch	MVZ	
3558-601-0	2.8 x 0.8	0.5 – 1.0 with notch pre-rolled	MVZ	
3558-87-1	Ø 0.35 - 0.50			
3558-87-2	Ø 0.75 - 1.50			

Cable lugs













3558-521-5	1.5 - 2.5 M4	MBL		
3558-521-7	1.5 - 2.5 M5	MVZ		
3558-521-9	1.5 - 2.5 M6	MVZ		
3558-522-1	1.5 - 2.5 M8	MBL		
3558-160-60	6.3 x 0.8	With MVZ hole	MVZ	
3558-160-61	6.3 x 0.8	With MVZ hole	MVZ	
3558-173-0	6.3 x 0.8	With MBL hole	MBL	

Key

MBL = clear brass MVZ = brass
tin plated BVZ = bronze tin plated
MSI = brass silver BBL = clear
bronze VGK = gold plated edges

Flat socket tongues

universal



3558-514-4	2,8	0.5 – 1.0 with hole	BVZ	
3558-505-41	2,8	1.5 – 2.5 with notch – with hole	BVZ	
3558-994-6	4,8	0.8 – 2.1 with notch	MVZ	
3558-996-0	6,3	0.5 – 1.0 with notch pre-rolled – with hole	MVZ	
3558-993-7	6,3	0.5 – 1.0 with notch pre-rolled – with hole	MSI	
3558-505-4	6,3	1.5 – 2.5 with notch pre-rolled – with hole	MBL	
3558-991-8	6,3	1.5 – 2.5 with notch pre-rolled – with hole	MVZ	
3558-501-9	6,3	1.5 – 2.5 pre-rolled – with hole	MBL	
3558-993-5	6,3	1.5 – 2.5 with notch pre-rolled – with hole	MSI	
3558-996-3	6,3	4.0 – 6.0 with notch – with hole	MVZ	
3558-87-11	Ø 0.35 - 0.50			
3558-87-21	Diameter 0.75 - 1.50			
3558-87-31	Ø 1.50 - 2.50			

Key



MBL = clear brass MVZ = brass
tin plated BVZ = bronze tin plated
MSI = brass silver BBL = clear
bronze VGK = gold plated edges

Angular blade receptacles







universal

3558-643-1	6.3 x 0.8	1.5 – 2.5 with notch MBL	
3558-994-1	6.3 x 0.8	1.5 – 2.5 pre-rolled MBL	
3558-643-6	9.5 x 1.2	2.5 – 4.0 with notch MVZ	

Patch panel

3558-928	6.3 x 0.8	6.3 x 0.8 MBL	
3558-514-3	6.3 x 0.8	scrolled up MBL	

VW special plug

3558-990-91	0.5 – 1.0 with notch pre-rolled		
3558-991-151	2,8/4,8 x 0,8	0.5 – 1.0 with notch pre-rolled	991-151 
3558-904-218	0.5 – 1.0 with notch pre-rolled	N904-218-02	
3558-904-220	2.5 – 4.0 with notch pre-rolled	N904-220-02	
3558-102-116	0.5 – 1.0 with notch pre-rolled	N102-116-06	
3558-904-887	1.5 – 2.5 with notch pre-rolled	N904-887-03	

Special plugs

3558-513-3	1.5 - 2.5 Ø 4		3558-997-3	1.5 - 2.5	
3558-990-9	0.5 - 1.5		3558-997-31	1.50 - 2.5	
3558-991-16	1.0 - 2.5		3558-990-2	0.50 - 2.5	
3558-994-7	0.8 - 2.1		3558-990-8	0.75 - 1.5	
3558-990-5	1.00 - 2.5		3558-990-6	1.00 - 2.5	
3558-992-4	0.50 – 1.0 2.8 notch		3558-997-6	1.5 - 2.5	
3558-995-8	0.50 - 1.5		3558-997-7	4	
3558-996-7	0.50 - 1.0		3558-996-4	0.5 - 1.0	
3558-996-9	1.50 - 2.5		3558-993-1	0.5 - 1.0	
3558-995-41	0.50 - 1.0		3558-998-1	0.5 - 0.75	
3558-997-0	0.50 - 1.0		3558-990-1	0.50 - 2.5	
3558-990-7	0.75 - 1.5				
3558-997-1	1.50 - 2.5				

Multiple connector shell

for flat socket tongues

Item no.	Plug connections Quantity/Fig.
3555-100-1	1 / -
3555-100-2	2 / =
3555-100-22	2 / 1 -
3555-100-4	4 / = =
3555-100-6	6 / = = =
3555-100-8	8 / = = = =

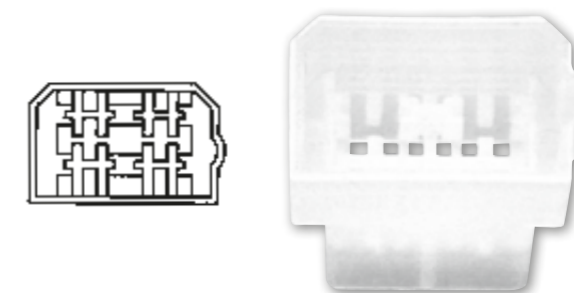

Flat socket tongues

with notch

Item no.	for cable Ø
3558-996-0	0,5 - 1,0
3558-991-8	1,5 - 2,5
3558-996-3	4,0 - 6,0



Multiple connector shell

for blade receptacles

Item no.	Plug connections Quantity/Fig.
3555-100-11	1 / -
3555-100-21	2 / =
3555-100-23	2 / 1 -
3555-100-41	4 / = =
3555-100-61	6 / = = =
3555-100-81	8 / = = = =

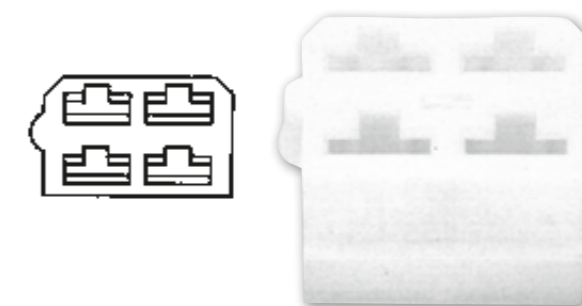

Blade receptacles

with notch

Item no.	for cable Ø
3558-991-6	0,5 - 1,0
3558-991-7	1,5 - 2,5



01

3-fold flat branch

Transparent

► Item no. 3555-11

► Technical specifications

- Threefold
- For push-on female connectors with 6.3 mm tab width
- Max. voltage 300 V
- Dimensions 54 mm x 21 mm

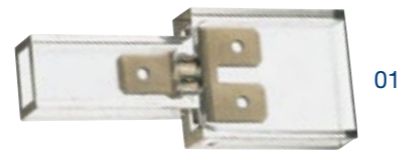

01

02

4-fold flat branch

Transparent

► Item no. 3555-12

► Technical specifications

- Fourfold
- For push-on female connectors with 6.3 mm tab width
- Max. voltage 300 V
- Dimensions 54 mm x 21 mm



02

03

Flat pin terminal boards

Blade receptacle with 6.3 mm tab width, max. voltage: 300 V



03

Item no.	Model	Dimensions
3555-2	short conductor insulation	125 x 25,8 mm
3555-4	long conductor insulation	144 x 48,0 mm

04

Wire end ferrule

Insulated, galvanised, tin plated, tube length 8 mm

► Product description

- Temperature range: -35°C to 105°C
- Moulded funnel taper: polypropylene



04

Item no.	Cross section	Colour
3557-000-50	0.50 mm ²	orange
3557-000-75	0.75 mm ²	white
3557-001-00	1.00 mm ²	yellow
3557-001-50	1,5 mm ²	red
3557-002-50	2.50 mm ²	blue
3557-004-00	4.00 mm ²	grey
3557-006-00	6.00 mm ²	black

05

Wire end ferrule

insulated, galvanised



05

Item no.	Cross section	Length
3557-184-177	0.75 mm ²	6 mm
3557-184-189	0.50 mm ²	6 mm
3557-175-916	1.00 mm ²	6 mm
3557-184-098	4.00 mm ²	12 mm
3557-175-928	1.50 mm ²	7 mm
3557-184-191	2.50 mm ²	7 mm

06

Luster terminals

06

Item no.	Cross section
3556-1	2.5 mm ²
3556-2	6.0 mm ²

01

Waterproof rack assortment► **Item no. 1957-560**

4 x Lock casing with gasket 2-fold (art. no. 3558-82)

4 x Lock casing with gasket 3-fold (art. no. 3558-83)

4 x Lock casing with gasket 4-fold (art. no. 3558-84)

4 x Lock casing with gasket 5-fold (art. no. 3558-85)

4 x Lock casing with gasket 6-fold (art. no. 3558-86)

4 x Mount casing 2-fold (art. no. 3558-82-1)

4 x Mount casing 3-fold (art. no. 3558-83-1)

4 x Mount casing 4-fold (art. no. 3558-84-1)

4 x Mount casing 5-fold (art. no. 3558-85-1)

4 x Mount casing 6-fold (art. no. 3558-86-1)

100 x push-on female connector 0.75 - 1.5 (art. no. 3558-87-2)

100 x push-on female connector 0.75 - 1.5 (art. no. 3558-87-21)

100 x sealing stopper yellow 0.75 - 1.5 (art. no. 3558-88-2)

100 x sealing stopper red 1.5 - 2.5 (art. no. 3558-88-3)



01

02

Sealing plug

Item no.	Colour	Ø cable
3558-88-1	orange	0,35 - 0,50
3558-88-2	yellow	0,75 - 1,50
3558-88-3	red	1,50 - 2,50
3558-88-4	yellow	



02

Blade receptacles

3558-87-1 Ø 0.35 - 0.50

3558-87-2 Ø 0.75 - 1.50

3558-87-3 Diameter 1.5 - 2.5

3558-87-11 Ø 0.35 - 0.50

3558-87-21 Diameter 0.75 - 1.50

3558-87-31 Ø 1.50 - 2.50



03

Supporting housing

waterproof, black

► **Product description**

- 1-6 fold

- Polyamide casing 6.6

Item no.	Model
3558-81-1	1 time
3558-82-1	2 times
3558-83-1	3 times
3558-84-1	4 times
3558-85-1	5-fold
3558-86-1	6 times



03

04

Bolt housing

waterproof, black

► **Product description**

- 1-6 fold

- Polyamide casing 6.6

Item no.	Model
3558-81	1 time
3558-82	2 times
3558-83	3 times
3558-84	4 times
3558-85	5-fold
3558-86	6 times

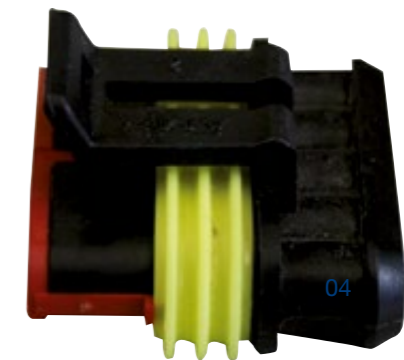

04

01

Cable straps
with plastic tongue



► **Product description**

- Temperature range: -40°C to +85°C
- Material: Polyamide 6.6
- Silicone-free

Item no.	Length	Width	Colour	Load capacity in Nm
3502-11	102 mm	2.5 mm	natural	80
3502-111	98 mm	2.5 mm	black	80
3502-12	150 mm	3.6 mm	natural	180
3502-121	140 mm	3.5 mm	black	180
3502-13	205 mm	3.6 mm	natural	180
3502-131	205 mm	3.6 mm	black	180
3502-135	295 mm	3.6 mm	natural	180
3502-135-1	290 mm	3.6 mm	black	180
3502-14	200 mm	4.8 mm	natural	220
3502-141	200 mm	4.5 mm	black	220
3502-15	282 mm	4.8 mm	natural	220
3502-151	282 mm	4.5 mm	black	220
3502-16	368 mm	4.8 mm	natural	220
3502-161	368 mm	4.8 mm	black	220
3502-165-1	500 mm	4.8 mm	Black	220
3502-171	200 mm	7.6 mm	black	550
3502-18	380 mm	7.5 mm	natural	550
3502-181	380 mm	7.5 mm	black	550
3502-185-1	550 mm	8 mm	Black	600
3502-191	762 mm	7.8 mm	black	800

02

Coloured cable ties
4.8 mm x 282 mm

► **Product description**

- Load capacity in Nm: 220
- Material: Polyamide 6.6, halogen-free, silicone-free
- Thermally stable: -40°C to +85°C
- Flammability class: UL 94 V-2

Item no.	Colour
3502-401	red
3502-402	blue
3502-403	yellow
3502-404	green



02

03

Cable straps
with metal tongue, UV-resistant



► **Product description**

- Temperature range: -40°C to +85°C
- Material: Polyamide 6.6
- Silicone-free



03

Item no.	Length	Width	Colour	Load capacity in Nm
3502-211	92 mm	2.4 mm	black	80
3502-221	140 mm	3.6 mm	black	180
3502-231	186 mm	4.8 mm	black	220
3502-241-0	360 mm	4.8 mm	black	220
3502-251-0	338 mm	7.6 mm	black	540
3502-201	208 mm	3.6 mm	black	220

04

Cable straps
removable, UV-resistant



► **Product description**

- Temperature resistance: up to +85°C
- Material: Polyamide 6.6



04

Item no.	Length	Width	Colour	Load capacity in Nm
3502-341-0	276 mm	4.8 mm	black	222
3502-351-0	376 mm	7.6 mm	black	334

05

Base of cable ties
self-adhesive



05

Item no.	for cable bandwidth
3502-636	3,6 mm
3502-648	4,8 mm
3502-665	7,8 mm

06

Socket for cable
self-adhesive



06

Item no.	for cable bandwidth
3502-71	5.0 mm ²
3502-72	8.0 mm ²
3502-73	16.0 mm ²

01

Crimping tool set 5 in 1

With 5 interchangeable crimping dies, forced lock, 2-K insulated handle grip

► Item no. 8558-100

► Product description

- Pliers for all occasions
- Simply replace the dies
- Ball bearings ensure optimal hold of the die
- Gas-free pressing is possible when repairing gas installations
- Includes practical case



01

OVERVIEW OF DIES/JAWS

Die A:

Die for insulated cable lugs 0.5 mm - 6.0 mm

Cable: flexible, cross-section 0.5 - 6.0 mm



A



B

Die B:

Die for non-insulated cable lugs 0.5 mm - 10.0 mm

Ideal for non-insulated contacts with closed surface, Suitable for eyelet lugs, terminal pins, joint connectors and small cable lugs

Cable: flexible, cross-section 0.5 - 10.0 mm



C



D

Die C:

Die for blade terminal 0.5 mm - 6.0 mm, up to 6.3 mm wide

Die D:

Die for ferrules 0.5 mm - 4.0 mm

Cable: flexible, cross-section 0.5 - 4.0 mm

Die E:

Die for ferrules 6.0 mm - 16.0 mm

Cable: flexible, cross-section 6.0 - 16.0 mm



E

02

Multimeter

With voltage sensor and LED torch

► Item no. 8715-64-581

► Product description

- DC voltage: 2, 20, 200, 400 V
- AC voltage: 200, 400 V
- DC current: 4 A
- AC current: 4 A
- Operating temperature range: 0°C to +40°C
- Storage temperature range: -10 to +50°C
- Functions: 678:678
- Contactless voltage test in the range from 100 - 600 V AC
- Diode test
- Auto Power Off function (after 15 minutes)
- Integrated white LED torch
- Dimensions: 140 x 70 x 35mm
- Weight: 250g incl. batteries
- IEC/EN 61010-1
- With two glass fuses



02

03

Voltage tester

3 V - 48 V

► Item no. 8715-64-59



03

04

Test lamp

6 V - 24 V

► Item no. 8715-64-60



04

01

Self-welding tape

10 m x 19 mm

▶ Item no. 3985-5

▶ Product description

- Colour: black
- Temperature range -40°C to +90°C
- Water-resistant
- High elasticity
- Processing temperature: +5°C to 35°C



02

Textile tapes

25 m x 19 mm, black

▶ Item no. 3985-2

▶ Product description

- Rot resistant
- Abrasion resistant
- Silencing
- Flexible
- Rippable
- Non-ageing
- High tack
- Temperature resistant up to +150°C



03

Extra wide insulation tape

10 m x 30 mm

▶ Item no. 3985-10-30

▶ Product description

- Colour: Black
- Thickness: 0.15 mm
- Temperature: -10°C to +90°C



04

Insulating tape

10 m x 15 mm

▶ Item no. 3985-7

▶ yellow

▶ Item no. 3985-1

▶ red

▶ Item no. 3985-6

▶ black

▶ Product description

- Thickness: 0.15 mm
- Temperature: -10°C to +90°C

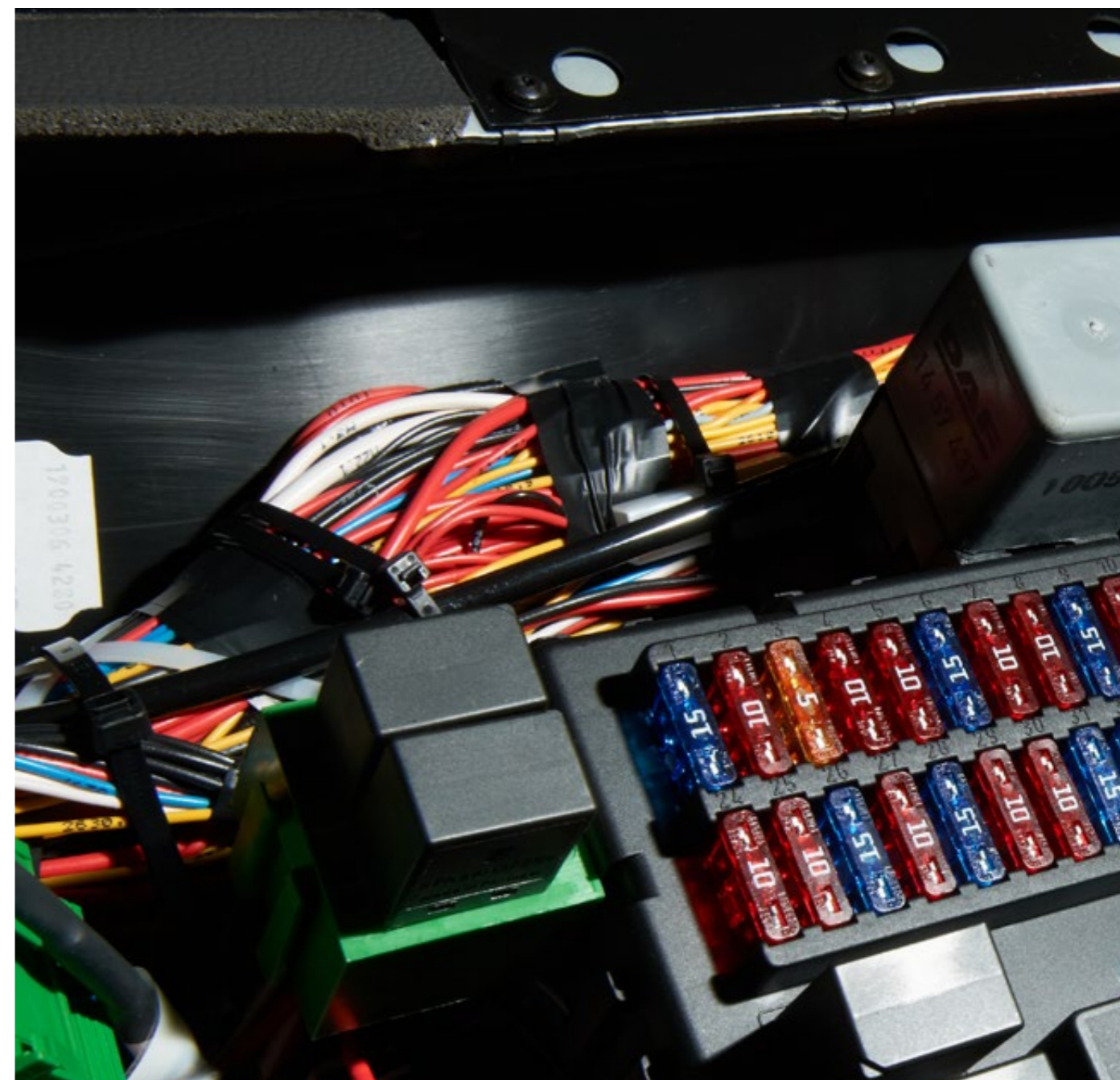

01

Heat-shrinkable tubing rods

coated with adhesive

► **Product description**

- Shrinkage ratio: 3:1
- Shrinkage temperature: 110°C
- Continuous temperature resistance: -55°C to +110°C

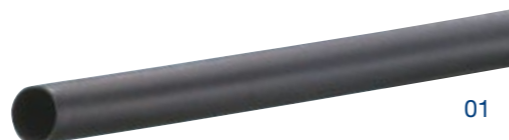

01

Item no.	Ø before shrinking	Ø after shrinking	VPE	Length
3771-000-031	3,2 mm	1,0 mm	10 rods	60 cm
3771-000-062	6,4 mm	2,0 mm	10 rods	60 cm
3771-000-124	12,7 mm	4,0 mm	4 rods	60 cm
3771-000-248	25,4 mm	8,0 mm	4 rods	60 cm

02

Pieces of heat shrinkable tube

Length: 10 cm

► **Product description**

- Shrinkage ratio: 2:1
- Shrinkage temperature: above 90°C
- Continuous temperature resistance: -55°C to +135°C
- Approval: UL 224



02

Item no.	Ø before shrinking	Ø after shrinking
3771-200-24	2,4 mm	1,2 mm
3771-200-32	3,2 mm	1,6 mm
3771-200-48	4,8 mm	2,4 mm
3771-200-64	6,4 mm	3,2 mm
3771-200-95	9,5 mm	4,7 mm
3771-200-127	12,7 mm	6,4 mm
3771-200-190	19,0 mm	9,5 mm
3771-200-254	25,4 mm	12,7 mm

03

Heat-shrinkable tubing spools► **Product description**

- Shrinkage ratio: 2:1
- Shrinkage temperature: 90°C
- Continuous temperature resistance: -55°C bis +125°C
- Material: Polyolefin



03

Item no.	Ø before shrinking	Ø after shrinking	Coil length
3771-001-2	1,2 mm	0,6 mm	20 m
3771-002-4	2,4 mm	1,2 mm	15 m
3771-003-2	3,2 mm	1,6 mm	15 m
3771-004-8	4,8 mm	2,4 mm	12 m
3771-006-4	6,4 mm	3,2 mm	12 m
3771-009-5	9,5 mm	4,7 mm	8 m
3771-012-7	12,7 mm	6,4 mm	8 m
3771-019-0	19,1 mm	9,5 mm	5 m
3771-025-4	25,4 mm	12,7 mm	5 m

04

Lighter gun

Weight: 60 g

► **Item no. 3555-999-1**► **Technical specifications**

- Dimensions: length 65 mm, height 110 mm, width 25 mm
- Max. temperature 1,300°C
- Working time (with filled lighter): 20 minutes
- Only use with the enclosed lighter
- The lighter inside is not filled
-
- We recommend filling with Normfest butane gas.



04

05

Butane gas► **Item no. 8714-607-100**

- **Contents: 100 ml**
- **Packing unit: 12**

► **Product description**

- Suitable for all common hot-melt and soldering guns



05

01

Insulating corrugated pipe

synthetic material, with slot, coil 2 m

► Product description

- Temperature range -40°C to +120°C
- Material: Polypropylene
- Protects vehicle cables against external influences

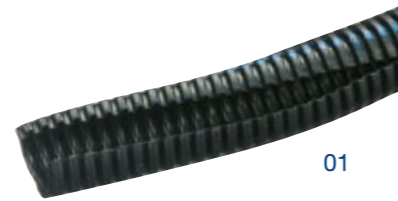

Item no.	Interior Ø
3505-1-6	6 mm
3505-1-9	9 mm
3505-1-11	11 mm
3505-1-13	13 mm
3505-1-16	16 mm
3505-1-19	19 mm
3505-1-23	22 mm

02

Insulating corrugated pipe

Plastic, without slot, coil 50 m

► Product description

- Temperature range -40°C to +120°C
- Material: Polypropylene
- Protects vehicle cables against external influences



Item no.	Interior Ø
3505-4-10	10 mm
3505-4-13	13 mm
3505-4-17	17 mm
3505-4-22	22 mm

03

Insulating tube

Coil 25 m

► Product description

- Temperature range -40°C to +90°C
- Material: PVC
- Silicone-free
- Non-fibrous



Item no.	Interior Ø
3771-3	3 mm
3771-4	4 mm
3771-5	5 mm
3771-6	6 mm
3771-8	8 mm
3771-10	10 mm
3771-12	12 mm

04

Speaker cable

50 m, brown-red

Item no.	Cable cross-section
3770-030-0	2 x 0.75 mm ²
3770-011-5	2 x 1.50 mm ²



05

Speaker cable

25 m, red-black-white-blue

Item no.	Cable cross-section
3770-400	4 x 0.75 mm ²



01

Automotive wires

Single wire, red, with double insulation (double jacket)

Item no.	Cable cross-section	Length
3770-020-1	1.5 mm ²	50 m
3770-020-4	2.5 mm ²	25 m



02

Automotive wires

2-wire, double insulated

Item no.	Model	Cable cross-section	Length
3770-020-0	flat	0.75mm ²	50 m
3770-020-2	flat	1.50 mm ²	25 m
3770-020-22	Flat	1,50 mm ²	100 m
3770-020-3	flat	2.50mm ²	15 m
3770-020-5	round	2.50 mm ²	15 m



03

Automotive wires

Vehicle cables with double insulation (double jacket)

Item no.	Cable cross-section	Length
3770-121	2 x 0.75 mm ²	50 m
3770-120	2 x 1.50 mm ²	50 m
3770-116	3 x 1.50 mm ²	50 m
3770-119-50	4 x 1.50 mm ²	50 m
3770-118-50	7 x 1.50 mm ²	50 m
3770-4-075	4 x 0.75 mm ²	50 m



04

Cable bushings

Double-sided, silicone-resistant

- ▶ Product description
- Protects against sharp edges

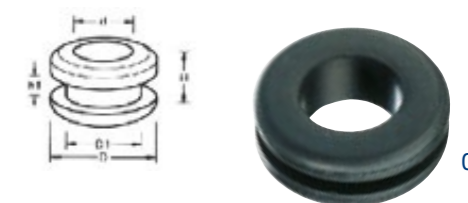

Item no.	d mm	D1 mm	D mm	H mm	H1 mm
3561-663-4	4	6	9	6	1,0
3561-663-2	6	9	11	6	1,0
3561-664-6	6	10	13	8	2,0
3561-664-8	9	11	16	6	1,0
3561-665-0	10	12	18	11	1,0
3561-665-2	12	20	24	10	4,0
3561-666-2	13	21	26	9	2,0
3561-666-3	16	24	3,0	11	3,0
3561-666-6	25	30	36	11	3,5
3561-666-5	21	31	38	11	1,5

05

Plug

Thermoplastic rubber

- ▶ Product description
- Ideal for sealing holes in sheet metal



Item no.	Outer diameter	Interior Ø
3561-700-1	27,5 mm	24,5 mm
3561-700-2	26,6 mm	22,0 mm
3561-700-3	22,1 mm	19,0 mm
3561-700-4	19,0 mm	15,5 mm
3561-700-5	18,4 mm	14,9 mm
3561-700-6	15,5 mm	12,7 mm
3561-700-7	12,8 mm	11,2 mm
3561-700-8	9,5 mm	6,4 mm

01

Automotive wiresØ 0.5 mm², 100 m, 1 core

Item no.	Colour
3770-050-0	black
3770-050-1	red
3770-050-2	blue



01

02

Automotive wiresØ 0.75 mm², 100 m, 1 core

Item no.	Colour
3770-007-5	black
3770-007-51	red
3770-007-52	blue
3770-007-59	brown



02

05

Automotive wiresØ 1.5 mm², 50 m, 1 core

Item no.	Colour
3770-020-11	grey-red
3770-020-12	black-red
3770-020-14	green-red
3770-020-16	black-white
3770-020-17	black-green



05

06

Automotive wiresØ 2.5 mm², 50 m, 1 core

Item no.	Colour
3770-010-5	black
3770-010-6	red
3770-010-60	yellow
3770-010-7	blue
3770-010-99	brown



06

03

Automotive wiresØ 1.0 mm², 100 m, 1 core

Item no.	Colour
3770-010	black
3770-009-01	red
3770-009-02	blue
3770-009-03	white
3770-009-05	yellow
3770-009-09	brown



03

04

Automotive wiresØ 1.5 mm², 100 m, 1 core

Item no.	Colour
3770-010-0	black
3770-010-1	red
3770-010-2	blue
3770-010-3	yellow
3770-010-4	green
3770-010-40	brown
3770-010-42	white



04

07

Automotive wiresØ 4.0 mm², 50 m, 1 core

Item no.	Colour
3770-040-1	black
3770-040-2	red

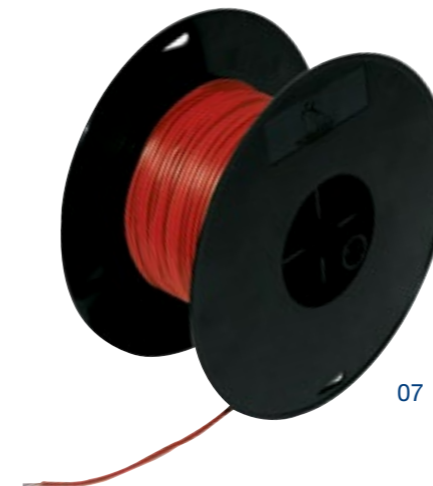

07

08

Automotive wiresØ 6.0 mm², 50 m, 1 core

Item no.	Colour
3770-060-1	black
3770-060-2	red



08

01

Blade fuse

Low profile



01

Item no.	Model	Colour
3731-302	2.0 A	grey
3731-303	3.0 A	Violet
3731-304	4.0 A	pink
3731-305	5.0 A	brownish
3731-307-5	7.5 A	brown
3731-310	10.0 A	red
3731-315	15.0 A	blue
3731-320	20.0 A	yellow
3731-325	25.0 A	transparent
3731-330	30.0 A	green

02

Blade fuse

Mini



02

Item no.	Model	Colour
3731-102	2,0 A	grey
3731-103	3,0 A	Violet
3731-104	4,0 A	pink
3731-105	5,0 A	brownish
3731-107-5	7,5 A	brown
3731-110	10,0 A	red
3731-115	15,0 A	blue
3731-120	20,0 A	yellow
3731-125	25,0 A	transparent
3731-130	30,0 A	green

05

Assortment of blade fuses

Mini and low-profile fuses

► Item no. 1957-730-2

Contents: 280 parts

25 x Plug fuse 3A MINI (art. no. 3731-103)
25 x Plug fuse 5A MINI (art. no. 3731-105)
25 x Plug fuse 7.5A MINI (art. no. 3731-107-5)
25 x Plug fuse 10A MINI (art. no. 3731-110)
25 x Plug fuse 15A MINI (art. no. 3731-115)
25 x Plug fuse 20A MINI (art. no. 3731-120)
25 x Plug fuse 25A MINI (art. no. 3731-125)
25 x Plug fuse 30A MINI (art. no. 3731-130)
25 x Plug fuse 3A / LOW-PROFILE (art. no. 3731-303)
25 x Plug fuse 5A / LOW-PROFILE (art. no. 3731-305)
25 x Plug fuse 7,5A / LOW-PROFILE (art. no. 3731-307-5)
25 x Plug fuse 10A / LOW-PROFILE (art. no. 3731-310)
25 x Plug fuse 15A / LOW-PROFILE (art. no. 3731-315)
25 x Plug fuse 20A / LOW-PROFILE (art. no. 3731-320)
25 x Plug fuse 25A / LOW-PROFILE (art. no. 3731-325)
25 x Plug fuse 30A / LOW-PROFILE (art. no. 3731-330)



05

03

Blade fuse

Normal



03

Item no.	Model	Colour
3731-002	2,0 A	grey
3731-003	3,0 A	Violet
3731-005	5,0 A	brownish
3731-007-5	7,5 A	brown
3731-010	10,0 A	red
3731-015	15,0 A	blue
3731-020	20,0 A	yellow
3731-025	25,0 A	transparent
3731-030	30,0 A	green
3731-040	40,0 A	orange

04

Blade fuse

Maxi



04

Item no.	Model	Colour
3731-220	20 A	yellow
3731-230	30 A	green
3731-240	40 A	orange
3731-250	50 A	red
3731-260	60 A	blue
3731-270	70 A	brownish
3731-280	80 A	transparent
3731-210-0	100 A	Violet

06

Assortment of blade fuses

► Item no. 1957-730-1

Contents: 161 parts

10 x 3A (art. no. 3731-003)
10 x 5A (art. no. 3731-005)
10 x 7.5A (art. no. 3731-007-5)
10 x 10A (art. no. 3731-010)
10 x 15A (art. no. 3731-015)
10 x 20A (art. no. 3731-020)
10 x 25A (art. no. 3731-025)
10 x 30A (art. no. 3731-030)
10 x 3A MINI (art. no. 3731-103)
10 x 5A MINI (art. no. 3731-105)
10 x 7.5A MINI (art. no. 3731-107-5)
10 x 10A MINI (art. no. 3731-110)
10 x 15A MINI (art. no. 3731-115)
10 x 20A MINI (art. no. 3731-120)
10 x 25A MINI (art. no. 3731-125)
10 x 30A MINI (art. no. 3731-130)
1 x Tester and gripper kit (art. no. 3731-150)



06



01

Screw type fuse mega

Mega, hole distance 51 mm



01

02

Screw type fuse midi

Midi, hole distance 30 mm



02

Item no.	Model	Colour
3731-9-100	100 A	yellow
3731-9-125	125 A	green
3731-9-150	150 A	red
3731-9-175	175 A	white
3731-9-200	200 A	blue
3731-9-225	225 A	brown
3731-9-250	250 A	Rose
3731-9-300	300 A	grey

Item no.	Model	Colour
3731-8-30	30 A	orange
3731-8-40	40 A	green
3731-8-50	50 A	red
3731-8-60	60 A	yellow
3731-8-70	70 A	brown
3731-8-80	80 A	white
3731-8-100	100 A	blue

05

Blade fuse

OTO-J



05

Item no.	Model	Colour
3731-5-20	20 A	turquoise
3731-5-25	25 A	white
3731-5-30	30 A	pink
3731-5-40	40 A	green
3731-5-50	50 A	red
3731-5-60	60 A	yellow

06

Blade fuse

OTO-JLP



06

Item no.	Model	Colour
3731-6-20	20 A	turquoise
3731-6-25	25 A	white
3731-6-30	30 A	pink
3731-6-40	40 A	green
3731-6-50	50 A	red
3731-6-60	60 A	yellow

03

Fuse holder

for MIDI fuse

► Item no. 3731-8-000



03

04

Fuse holder

for MEGA fuse

► Item no. 3731-9-000



04

07

Blade fuse

OTO-B / BT



07

Item no.	Model	Colour
3731-7-30	30 A	pink
3731-7-40	40 A	green
3731-7-50	50 A	red
3731-7-60	60 A	yellow
3731-7-70	70 A	brown
3731-7-80	80 A	black
3731-7-100	100 A	blue
3731-7-120	120 A	white
3731-7-140	140 A	dark red

01
Fuse strip

Item no.	Model
3730-25-5	25
3730-25-8	50
3730-25-161	50
3730-25-25	25
3730-25-40	25



01

02
Metal strip fuse

Item no.	Model
3731-50	50 A
3731-80	80 A



02

03
Visible type fuse

Item no.	Model
3733-20-1	1,00 A
3733-20-2	2,00 A
3733-20-315	3,15 A
3733-20-4	4,00 A
3733-20-5	5,00 A



03

04
MSO fuses

Installed in almost all vehicles of the VW Group (Volkswagen, Skoda, Audi and Seat)

Item no.	Model
3731-10-30	30 A
3731-10-40	40 A
3731-10-50	50 A
3731-10-60	60 A
3731-10-70	70 A
3731-10-80	80 A
3731-10-100	100 A



04

05
Fuse distributor
 incl. cable and plug

► Item no. 3731-000-400

► Item no. 3731-000-500

► Product description

- Designed for the installation of additional devices in vehicles, e.g LED daytime running light
- 2 fuse slots
- Easy and secure installation
- Cable length: 10 cm



05

06
Fuse holder

► Item no. 3555-625

► Product description

- incl. 8 A fuse
- with bayonet catch for strip fuses



06

07
Flat fuse holder for blade fuse

► Item no. 3731-000

► Product description

- with connection for 6.3mm wide blade receptacles



07

08
Flat fuse holder "maxi"

► Item no. 3731-200

► Product description

- for cable lugs and M5 bolts
- for cable cross-sections of between 2,5 mm² and 10 mm²



08

09
Blade fuse holder

► Item no. 3555-972

► Product description

- Rapid connector
- For cable cross-sections 0.75 mm² - 2.0 mm²



09

10
Cover
 for flat fuse holder

► Item no. 3731-200-9



10

11
Tester and gripper set
 for blade fuses

► Item no. 3731-150



11

12
Flat fuse holder for blade fuse

► Item no. 3731-000-200

► Product description

- Cable length: each 25 cm
- Cable cross-section: each 1.5 mm²
- For fuses up to 20 A



12

13
Flat fuse holder

► Item no. 3731-100

► Product description

- Cable length: each 13 cm
- Cable cross-section 3.3 mm²



13

14
Flat fuse holder for blade fuse

► Item no. 3731-000-300

► Product description

- Cable length: each 25 cm
- Cable cross-sections: each 2.5 mm²
- For fuses up to 30 A



14

01

Mini-short adaptor

7-pole to 13-pole

▶ Item no. 3555-310-112

▶ Product description

- Towing vehicle with 7-pole coupling
- Trailer with 13-pole plug
- Length: 50 mm
- Material: PA6 GF30
- 12 V



02

Short adaptor

13-pole to 7-pole

▶ Item no. 3555-310-12

▶ Product description

- Towing vehicle with 13-pole coupling
- Trailer with 7-pole plug
- Length: 106 mm
- Material: PA6 GF30
- 12 V



05

Plug

7-pole

▶ Item no. 3555-305-517

▶ Light metal

▶ Item no. 3555-405-517

▶ Plastic

▶ Product description

- Length: 91.8 mm
- Power rating: 20 A at 12 V
- With screwed contact
- For insertion



06

Plug

13-pole

▶ Item no. 3555-310-517

▶ Product description

- Plastic
- Power rating: 20 A at 12 V
- with bayonet catch
- 12 V
- 13-polig



03

Mini-short adaptor

13-pole to 7-pole

▶ Item no. 3555-310-119

▶ Product description

- Towing vehicle with 13-pin coupling
- Trailer with 7-pin plug
- Material: PA6 GF30
- Total length: 52 mm
- 12 V



04

Short adaptor

13-pole DIN/ISO11446 box to 7-pole

▶ Item no. 3555-310-13

▶ Product description

- Length: 106 mm
- Material: PA6 GF30
- 13/7
- WeSt-System
- 12 V



07

Power outlet

7-pole

▶ Item no. 3555-305-117

▶ Light metal

▶ Item no. 3555-305-118

▶ Gasket

▶ Item no. 3555-405-117

▶ Plastic

▶ Item no. 3555-310-120

▶ Spare gasket

▶ Product description

- Length: 44 mm
- Power rating: 20 A at 12 V
- Screwed connection



08

Power outlet

13-pole, incl. grommet

▶ Item no. 3555-310-117

▶ Plastic

▶ Item no. 3555-310-120

▶ Spare gasket

▶ Product description

- Length: 50 mm
- Power rating: 20 A at 12 V
- OEM version
- Material: PA6 GF30



01

Plug

15-pole

▶ Item no. 3555-310-150

▶ Product description

- With screwed contacts
- GGVS/ADR tested
- 15-pole
- 24 V



01

02

Plug

7-pole

▶ Item no. 3555-310-70

▶ Product description

- With screwed contacts
- GGVS/ADR tested
- 7-pole
- 24 V



02

03

Plug

7-pole

▶ Item no. 3555-305-589

▶ Plastic

▶ Item no. 3555-305-587

▶ Metal

▶ Product description

- Power rating: 20 A to 24 V
- Length: 116 mm
- Type N / "Light"
- With screwed contacts



03

04

Plug

7-pole

▶ Item no. 3555-305-588

▶ Plastic

▶ Item no. 3555-305-586

▶ Metal

▶ Product description

- Power rating: 20 A to 24 V
- Length: 116 mm
- Type S / "Auxiliary consumer"
- With screwed contacts



04

05

Plug

3 pole

▶ Item no. 3555-310-6

▶ Product description

- With screwed contacts
- Type S
- Power rating: 20 A to 24 V
- Plastic
- 3-pole
- 24 V



05

06

Socket

7-pole

▶ Item no. 3555-310-7

▶ Product description

- With screwed contacts
- GGVS/ADR tested
- 7-pole
- 24 V



06

07

Power outlet

7-pole

▶ Item no. 3555-305-287

▶ Product description

- With screwed contacts
- Rubber seal in the cover
- Type N
- Load rating: 20 A to 24 V
- ISO 1185 K-pin
- 7-pole
- 24 V



07

08

Power outlet

7-pole

▶ Item no. 3555-305-286

▶ Product description

- With screwed contacts
- Rubber seal in the cover
- Type S
- Load rating: 20 A to 24 V
- ISO 3731 K-jack
- 7-pole
- 24 V



08

09

Power outlet

3 pole

▶ Item no. 3555-310-60

▶ Product description

- With screwed contacts
- Type S
- Power rating: 20 A to 24 V
- Plastic
- ISO 1185 K
- 7-pole
- 24 V



09

10

Power outlet

15-pole

▶ Item no. 3555-310-15

▶ Product description

- With screwed contacts
- GGVS/ADR tested
- 15-pole
- 24 V



10

01

Adapter helix cable

15 pole to 2 x 7 pole

▶ Item no. 3555-320-53

▶ Product description

- For the power supply from new truck tractors to older trailers
- 13 pole wired according to standards
- Overmoulded plug type „N“ and type „S“
- Working length: 3.5 m
- Material: PUR
- Recoiling force complies with OEM regulations
- Tightly wound
- 24 V



01

02

Short adapter

15-pole to 7-pole

▶ Item no. 3555-320-52

▶ Product description

- Adapter from 15-pole to 7-pole
- ISO 12098
- Plastic
- 24 V



02

05

Coil

7-pole

▶ Item no. 3555-320-42

▶ Product description

- Working length: 3.0 m
- Material: PUR
- Recoiling force complies with OEM regulations
- With waterproof plugs
- Type N
- Tightly wound



05

06

EBS helix cable

7-pole

▶ Item no. 3555-320-45

▶ Product description

- Working length: 3.5 m
- Material: PUR
- Recoiling force complies with OEM regulations
- Tightly wound



06

03

Adapter helix cable

15 pole to 2 x 7 pole

▶ Item no. 3555-320-51

▶ Product description

- 13 pole
- Working length: 3,5 m
- Type N/S
- Material: PUR
- Recoiling force complies with OEM regulations
- Tightly wound
- 24 V



03

04

Coil

7-pole

▶ Item no. 3555-320-43

▶ Product description

- Working length: 3.0 m
- Material: PUR
- Recoiling force complies with OEM regulations
- With waterproof plugs
- Type S - 3731
- 6 sockets, 1 pin



04

07

Coil

15-pole

▶ Item no. 3555-320-50

▶ Product description

- Working length: 3.5 m
- With clamped connection
- Material: PUR
- Recoiling force complies with OEM regulations
- Tightly wound



07

08

Distribution box

16-fold

▶ Item no. 1004-100

▶ Product description

- GGVS/ADR inspected
- 16-fold



08

01

Soldering cable lugs

Item no.	Bore hole	wire cross section d1	DIN Product name	d2
3557-921-9	M6	10 mm ²	6 x 4,3	11
3557-922-0	M8	10 mm ²	8 x 4,3	15
3557-922-4	M8	16 mm ²	8 x 5,4	15
3557-922-8	M8	25 mm ²	8 x 6,8	15
3557-922-81	M8	35 mm ²	8 x 8,2	15
3557-923-6	M8	50 mm ²	8 x 9,5	17
3557-922-1	M10	10 mm ²	10 x 4,3	19
3557-922-9	M10	25 mm ²	10 x 6,8	19
3557-923-3	M10	35 mm ²	10 x 8,2	19
3557-923-7	M10	50 mm ²	10 x 9,5	19
3557-924-0	M10	70 mm ²	10 x 11,2	21
3557-923-0	M12	25 mm ²	12 x 6,8	22
3557-923-8	M12	50 mm ²	12 x 9,5	22
3557-924-1	M12	70 mm ²	12 x 11,2	22

02

Soldering iron

230 V, 150 W

▶ Item no. 4982-900

▶ Product description

- Temperature range: 450°C
- Suitable for soldering tasks with high heat requirements, e.g. copper wires with a cross section up to 6 mm²
- Ideal for soldering tin sheet metal
- Warm-up time: 3 minutes



03

Soldering wire

Rolls 250 g each

▶ Item no. 4982-60

▶ Ø 2 mm

▶ Item no. 4982-50

▶ Ø 1 mm

▶ Product description

- Liquid agent quantity: 3.5%
- Alloy: PB6OSN40
- Melting range: 183°C - 238°C

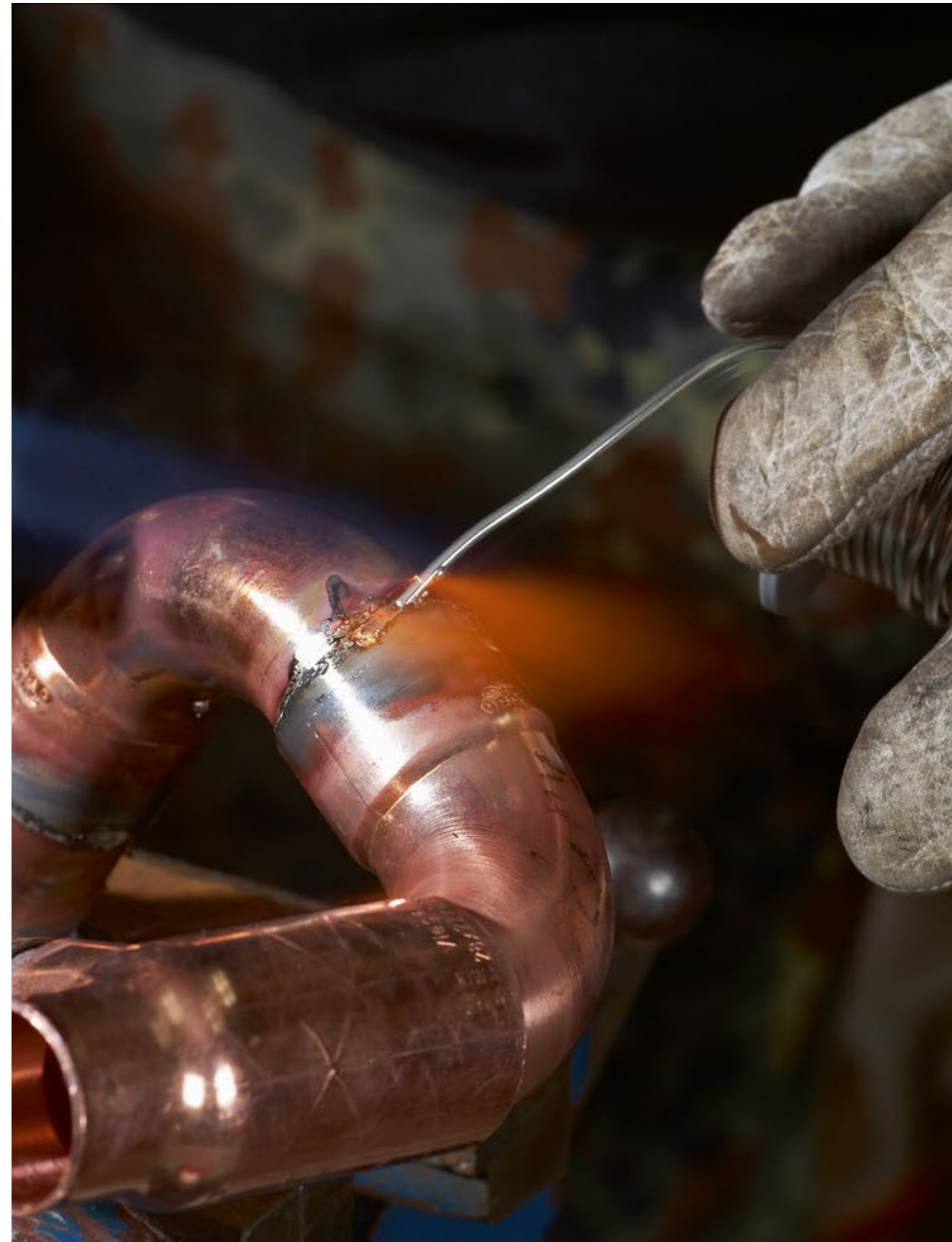

Tyre mounting



01

Zinc adhesive weights 45 g

Plastic coating

▶ Item no. 9834-14-745

▶ Product description

- Width: 19.0 mm
- Height: 3.8 mm
- Segments: 5 g + 10 g
- Impact-resistant plastic coating



01

02

Zinc adhesive weights 60 g ECO

powder coated

▶ Item no. 9837-67-60

▶ Product description

- Width: 19.0 mm
- Height: 4.0 mm
- Segments: 5 g
- Surface: powder-coated



02

03

Adhesive zinc weights - 5 kg roll

powder coated

▶ Item no. 9836-15-700

▶ Product description

- Endless adhesive weight with 1,000 segments x 5 grams (5kg)
- With impact-resistant plastic coating in grey
- Width: 19 mm
- Height: 3.8 mm incl. adhesive tape
- Weight material: Zinc
- Adhesive tape: High-quality double-sided adhesive tape with blue liner
- Coating: High-quality powder coating / uncoated, galvanized
- Corrosion resistance: ≥ 250h in salt spray test to DIN EN ISO 9227



03

04

Cutter for adhesive wheel balancing weight rolls

with wall attachment

▶ Item no. 9836-5

▶ Product description

- Cutter for adhesive strips on a roll
- Scaling for 5.0 g and 2.5 g weights
- User-friendly cutter
- Replaceable blade
- Simple wall mounting (front or side)



04



OFF YOU GO:
CHANGE THE
TYRES!

01

Steel adhesive weights black 60 g

Impact-resistant plastic coating

► Item no. 9834-97-60

► Product description

- Width: 19.0 mm
- Height: 4.0 mm
- Segments: 5 g
- Impact-resistant black plastic coating
- OEM quality



01

02

Steel adhesive weights 60 g ECO

impact-resistant plastic coating

► Item no. 9834-397-60

► Product description

- Weight: 12 x 5g
- Width: 19 mm
- Height: 3.7 mm incl. adhesive tape
- Weight identification: Fe (iron)
- Area of application: Almost all light-metal rims



02

03

Adhesive steel weights - 5 kg roll

powder coated

► Item no. 9836-15-500

► Product description

- Endless adhesive weight with 1,000 segments x 5 grams (5kg)
- With impact-resistant plastic coating in grey
- Weight material: steel
- Height: 3.5 mm incl. adhesive tape
- Width: 19 mm
- Adhesive tape: High-quality double-sided adhesive tape with blue liner
- Coating: High-quality powder coating / uncoated, galvanized
- Corrosion resistance: ≥ 250h in salt spray test to DIN EN ISO 9227



03

04

Adhesive weight

Plastic coating

► Product description

- Above 25 g with one notch
- Above 45 g with two notches
- To facilitate moulding to the rim radius
- OEM quality



04

Item no.	Weight	Width x height	Item no.	Weight	Width x height
9834-912-5	5 g	15 mm x 3,8 mm	9834-912-35	35 g	19 mm x 3,8 mm
9834-912-10	10 g	15 mm x 3,8 mm	9834-912-40	40 g	19 mm x 3,8 mm
9834-912-15	15 g	19 mm x 3,8 mm	9834-912-45	45 g	19 mm x 3,8 mm
9834-912-20	20 g	19 mm x 3,8 mm	9834-912-50	50 g	19 mm x 3,8 mm
9834-912-25	25 g	19 mm x 3,8 mm	9834-912-55	55 g	19 mm x 3,8 mm
9834-912-30	30 g	19 mm x 3,8 mm	9834-912-60	60 g	19 mm x 3,8 mm

05

Adhesive lead strip 40 g

For motorcycles

► Item no. 9836-17-60

► Product description

- Width: 10 mm
- Height: 4.7 mm
- Segments: 8 x 5 g



05



01
Universal balance weights
 for steel rims, powder-coated

- Technical specifications
- OEM quality



Item no.	Weight	Item no.	Weight
9836-1-5	5 g	9836-1-35	35 g
9836-1-10	10 g	9836-1-40	40 g
9836-1-15	15 g	9836-1-45	45 g
9836-1-20	20 g	9836-1-50	50 g
9836-1-25	25 g	9836-1-55	55 g
9836-1-30	30 g	9836-1-60	60 g

02
Universal balance weights
 For light-metal rims, powder coated

- Product description
- OEM quality



Item no.	Weight	Item no.	Weight
9836-3-5	5 g	9836-3-30	30 g
9836-3-10	10 g	9836-3-35	35 g
9836-3-15	15 g	9836-3-40	40 g
9836-3-20	20 g	9836-3-45	45 g
9836-3-25	25 g	9836-3-50	50 g

03
Universal balance weight ECO
 for alloy rims,
 powder-coated



03

Item no.	Weight	Item no.	Weight
9837-3-5	5 g	9837-3-30	30 g
9837-3-10	10 g	9837-3-35	35 g
9837-3-15	15 g	9837-3-40	40 g
9837-3-20	20 g	9837-3-45	45 g
9837-3-25	25 g	9837-3-50	50 g



04
Plug-type wheel balance weight type 75
 For Mercedes steel and aluminium wheel rims



Item no.	Weight	Item no.	Weight
9834-75-5	5 g	9834-75-40	40 g
9834-75-10	10 g	9834-75-45	45 g
9834-75-15	15 g	9834-75-50	50 g
9834-75-20	20 g	9834-75-55	55 g
9834-75-25	25 g	9834-75-60	60 g
9834-75-30	30 g	9834-75-001	For aluminium wheel rims
9834-75-35	35 g		



05
Universal balance weight ECO
 For steel rims, coated

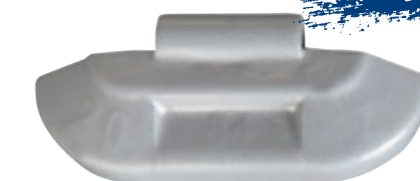

05

Item no.	Weight	Item no.	Weight
9837-5-5	5 g	9837-5-30	30 g
9837-5-10	10 g	9837-5-35	35 g
9837-5-15	15 g	9837-5-40	40 g
9837-5-20	20 g	9837-5-45	45 g
9837-5-25	25 g	9837-5-50	50 g

01

Zinc striking weights for FORD steel rims type 187

Zinc striking weights for FORD steel rims type 187

► Technical specifications

- Genuine part for FORD Transit and FORD Transit Custom 05/2014



Item no.	Weight	Item no.	Weight
9836-187-10	10 g	9836-187-40	40 g
9836-187-15	15 g	9836-187-45	45 g
9836-187-20	20 g	9836-187-50	50 g
9836-187-25	25 g	9836-187-55	55 g
9836-187-30	30 g	9836-187-60	60 g
9836-187-35	35 g		

02

Zinc striking weights for steel rims type 164

For steel rims type 164

► Technical specifications

- Genuine part for MERCEDES-BENZ Sprinter
 - For steel rims on French vehicles
 - For steel rims on light commercial vehicles
 (with greater material thickness of rims)
 - FORD Transit up to 2013
 - VW Crafter



Item no.	Weight	Item no.	Weight
9836-164-5	5 g	9836-164-35	35 g
9836-164-10	10 g	9836-164-40	40 g
9836-164-15	15 g	9836-164-45	45 g
9836-164-20	20 g	9836-164-50	50 g
9836-164-25	25 g	9836-164-55	55 g
9836-164-30	30 g	9836-164-60	60 g

03

Wheel balance weight for 15° tapered rims

Lead, from 22.5" x 6.75" to 26 inches



Item no.	Weight	Item no.	Weight
9836-32-50	50 g	9836-32-250	250 g
9836-32-75	75 g	9836-32-300	300 g
9836-32-100	100 g	9836-32-350	350 g
9836-32-150	150 g	9836-32-400	400 g
9836-32-200	200 g		

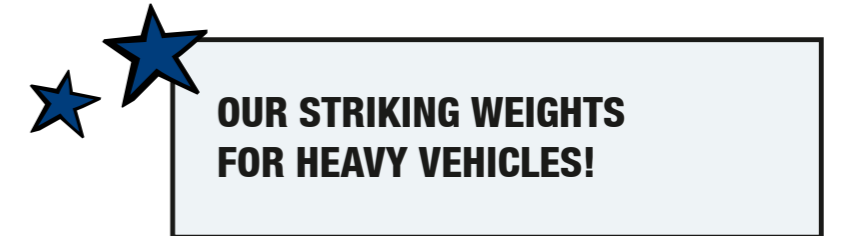

04

Striking weight for 15° tapered rims

Lead, from 22,5 x 6,75 to 26,50 x 12,00



Item no.	Weight	Item no.	Weight
9836-32-75	75 g	9836-32-250	250 g
9836-32-50	50 g	9836-32-300	300 g
9836-32-100	100 g	9836-32-350	350 g
9836-32-150	150 g	9836-32-400	400 g
9836-32-200	200 g		

01

Rubber valve

Item no.	Total length (without cap)	Model
9879-412	33 mm	OEM quality
9879-413	43 mm	OEM quality
9879-414	48 mm	OEM quality
9879-418	61 mm	OEM quality
9879-413-4	43 mm	ECO
9879-414-4	48 mm	ECO
9879-418-4	61 mm	ECO



01

02

Metal valve

For vans, PCVs and vehicles with high tyre pressure

► Product description

- Pressure-resistant up to 14 bar
- Wrench size 11
- High-temperature seal for peak temperatures of over +150°C



02

Item no.	Total length (without cap)	Width across flats
9879-413-40	40 mm	11 mm
9879-414-47	47 mm	11 mm

03

Metal valve

Item no.	Model	Width across flats
9879-563	43 mm	14 mm
9879-563-1	with high nut	11 mm



03

04

Aluminium valve black

► Item no. 9879-563-2

► Product description

- Valve hole diameter: 11.3 + 0.4mm
- Rim thickness: 1.8 - 4mm
- Valve length: 42 mm
- Key width: 11 mm
- Tightening torque: 4 + -0.5 Nm
- Pressure range: up to max. 14 bar



04

06

Commercial vehicle valve

Alligator, CVV

► Item no. 9879-530-40

► 40 mm

► Item no. 9879-530-47

► 47 mm

► Item no. 9879-530-60

► 60 mm



06

05

Special Ford valve

Rubber valve

► Item no. 9879-414-2

► Product description

- Valve length: 56.6 mm
- Rim thickness: 1.8 mm - 4 mm
- ETRTO No.: V2.03.8
- TR No.: 414L
- Valve hole diameter (mm): 11.3 + 0.4
- Pressure range: < 4.5 bar
- Up to a speed of 210 km/h



05

07

Valve

For tubeless commercial vehicle tyres, straight version

► Item no. 9879-800-41

► 9.7 x 41 mm

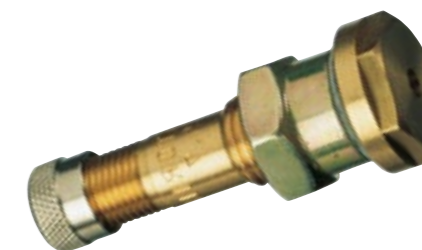

07

01

Valve extension from plastic, black

- ▶ Item no. 9879-71
- ▶ 19 mm

- ▶ Item no. 9879-73
- ▶ 38 mm



01

02

Valve insert

short model

- ▶ Item no. 9879-44

- ▶ Product description
- Material: Nickel-plated brass
- Opening pressure: 3 bar +/- 25%
- Working pressure: < 20 bar
- Starting torque: 25 - 30 Ncm



02

03

Valve cap

Metal

- ▶ Item no. 9879-46

- ▶ Product description
- Prevents corrosion at the valve thread



03

04

Valve cap

Metal

- ▶ Item no. 9879-47

- ▶ Product description
- Prevents corrosion at the valve thread
- Made from nickel-plated brass with a seal
- With extractor for valve insert



04

08

Valve cap

Plastic

- ▶ Item no. 9879-45
- ▶ black

- ▶ Item no. 9879-48
- ▶ red

- ▶ Item no. 9879-49
- ▶ green with valve gasket



05

06

Wheel nuts Ford

OE no. 1007487, 6040307, 1447852

M12 x 1.5 galvanised
Quality 8 Wrench size 19

- ▶ Item no. 6395-12-15

OE no. 1470843
M12 x 1.5 galvanised
Quality 10, Wrench size 19

- ▶ Item no. 6395-12-151



06

07

Wheel nuts MazdaMazda, Mitsubishi, Toyota
OE no. Mazda 0603-26-161
OE no. Mitsubishi MA103087
OE no. Toyota 90942-01001-83
M12 x 1.5 yellow passivated
Quality 8 Wrench size 21

- ▶ Item no. 6395-012-15



07

08

Wheel bolts Audi / VWVolkswagen / Audi OE-no. 8D0
601 139 D M14 x 1.5 x 25.5
Geomet black FK 8.8 Wrench size 17

- ▶ Item no. 6395-214-15



08

09

Screwing tool

for all common valves

- ▶ Item no. 9879-54-00

- ▶ Product description
- Tightening torque: approx. 25-30 Nm



09

10

Adhesive weights remover

Plastic

- ▶ Item no. 8715-64-80



10

11

Tyre valve insert tool

Coated in plastic

- ▶ Item no. 9879-54-041

- ▶ Product description
- Length: 290 mm



11

12

Extension cap with seal

Check valve

- ▶ Item no. 9879-66



12

13

Valve extension

Air-Flexx, steel, flexible

- ▶ Item no. 9879-700-145
- ▶ 145 mm

- ▶ Item no. 9879-700-185
- ▶ 185 mm

- ▶ Item no. 9879-700-215
- ▶ 215 mm



13

14

Valve extension

Plastic, rigid

- ▶ Item no. 9879-74
- ▶ 115 mm

- ▶ Item no. 9879-75
- ▶ 150 mm

- ▶ Item no. 9879-76
- ▶ 170 mm

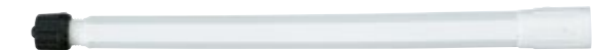

14

01

Valve lever connector

for tyre hand-held gauges

▶ Item no. 9879-54-06

▶ Product description

- For hose inner diameters of 6 mm
- Total length approx. 40 mm
- Diameter of valve on inlet side approx. 18 mm
- Pin diameter: 7mm



01

02

Quick plug connection

With hose 18 x 1.5 mm

▶ Item no. 9879-54-08



02

03

Service station air chucks

for tyre hand-held gauges

▶ Item no. 9879-54-07

▶ Product description

- For hose inner diameter of 7 mm
- Diameter of connector 8 mm
- Length about 355



03



04

Tyre hand-held gauges

Suitable for PCVs and HGVs, calibrated

▶ Item no. 9879-54-05

▶ Product description

- Calibrated (for two years from stamp date)
- Filling pressure: max. 12 bar
- For cars/HGVs
- Rubber protective cap protects mechanism from external impacts
- Overpressure safety protection
- Easy to read
- Weight-optimized design
- Integrated anti-kinking stabilizes the filling hose at the start
- 500 mm-long filling hose for valves hard to access
- With suspension loop
- Ergonomic structure
- Single-lever operation
- PTB approval
- Checks on compressed air possible even without pressurization



04

05

Tyre hand-held gauges

With digital display, calibrated

▶ Item no. 9879-54-04

▶ Product description

- Calibrated
- PTB approval
- Modern, light, impact-resistant construction
- Clear, easy-read display
- Single-stage valve design increases filling and deflating speed
- Overpressure warning if pressure exceeds 12 bar/174 PSI/1,200 kPa
- Warning light for weak battery
- Connecting thread: 1/4" internal thread
- Hose length: 180 cm
- Max. inlet pressure: 15 bar
- Max. inflation time: 910 i/min
- Inflation range: 0 - 12 bar
- Battery type art. no.: 3722-32 CR 2450
- Life of battery: up to 950h



05



01
Tyre installation paste
TAP

- ▶ Item no. 2894-455
- ▶ Contents: 5 kg
- ▶ Packing unit: 1

Black



- ▶ Item no. 2894-457
- ▶ Contents: 5 kg
- ▶ Packing unit: 1

White



- ▶ Product description
- Suitable for run-flat tyres
- Frost-proof
- Rapid drying, so that tyre cannot slip on rim
- Outstanding exhaust air behaviour
- High slip
- Biodegradable
- No risk of allergies for fitters



01

02
Tyre bags
100 pcs.

- ▶ Item no. 7875-906
- ▶ 700 x 260 x 1,000 mm

- ▶ Item no. 7875-909
- ▶ 700 x 500 x 1,200 mm



02

03
Tyre chalk

- ▶ Item no. 9879-91-3
- ▶ white

- ▶ Item no. 9879-91-4
- ▶ yellow



03

04
Tyre chalk retainer

- ▶ Item no. 9879-91-5



04

05
Brush
for tyre mounting paste

- ▶ Item no. 4693-080-0



05



01

Tyre repair kit up to 210 km/h

Tyron 5 mm

► **Item no. 9879-970**► **Product description**

- 100% self-vulcanising bands
- Bands passed all TÜV endurance and high-speed tests with overload
- Extremely tear proof and shear resistant in tyres and steel belts thanks to leading-edge technology
- Can be used for straight and 45° punctures
- Suitable for all tubeless tyres on cars and vans
- For tyres up to 210 km/h!

- Set content:

- 50 x 5mm repair body (article no. 9879-972 - refill pack)
- 1 x pilot awl (article no. 9879-976)
- 1 x T-handle (article no. 9879-975)
- 1 x awl (article no. 9879-978)
- 1 x vulcanizing mass 25ml (article no. 9879-980)
- 1 x liquid patch 50ml (article no. 9879-979)
- 1 x scraper
- 1 x Allen key



01

01

Refill pack for H tyres

Tyron 5 mm up to 210 km/h

► Item no. 9879-972

► Product description

- 100% self-vulcanising bands
- Bands passed all TÜV endurance and high-speed tests with overload
- Extremely tear proof and shear resistant in tyres and steel belts thanks to leading-edge technology
- Can be used for straight and 45° punctures
- Suitable for all tubeless tyres on cars and vans
- For tyres up to 210km/h!

- Content:

- 50 x 5 mm repair body
- 1 x liquid patch 50 ml



01

02

Refill pack for V tyres

Tyron 3 mm above 210 km/h

► Item no. 9879-973

► Product description

- 100% self-vulcanising bands
- Bands passed all TÜV endurance and high-speed tests with overload
- Extremely tear proof and shear resistant in tyres and steel belts thanks to leading-edge technology
- Can be used for straight and 45° punctures
- Suitable for all tubeless trucks and motorbikes
- For tyres up to 270km/h!

- Content:

- 50 x 3 mm repair body
- 1 x liquid patch 50 ml



02

03

Tyre repair system

Tyrex starter kit

► Item no. 9879-921

► Product description

- Mushroom-shaped repair body, suitable for radial and diagonal tyres
- Licensed for speed class V
- Only use in association with vulcanizing mass (article no. 9879-94-250)

- Set content:

- 20 x 3mm repair body
- 15 x 6mm repair body
- 1 x 3mm burr
- 1 x 6mm burr
- 5 x vulcanizing mass 15g tube



03

04

Adhesive for tyre probes

Tyrex

► Item no. 9879-94-250

► Contents: 237 ml

► Packing unit: 1

05

Special rubber milling cutter

For roughening the inner surface of tyres

► Item no. 9879-91-1

06

Tread roller

for tyre probes

► Item no. 9879-91-2



04

05

06



01

Diagnostic device

TEXA TPS Standard

▶ Item no. 9879-100-001

▶ **Product description**

- Fast reading of the sensor ID and associated parameters
- Copying sensor IDs
- Writing of copied or manually entered sensor IDs
- Can be used with the free TPMS-Repair app on PCs, Axone 4 and Axone 4 Mini (if IDC4 CAR and Bluetooth® aerial present in PC)

- Package:

- TPS hand-held device
- USB power supply unit
- USB cable
- Operating instructions



02

Mobile multi-make diagnostic device

With 5.0" TFT-LCD touchscreen

▶ Item no. 9879-100-002

▶ **Product description**

- Mobile multi-make diagnostic device with 5.0" TFT-LCD touchscreen
- Cable-free working thanks to integrated WLAN and Bluetooth® modules
- Bluetooth® diagnostic interface with EOBD plug
- TPS expansion for reading, copying and programming TPMS sensors
- Multi-make diagnostic software "IDC4a FAST FIT" for service work on vehicles:
 - Chassis settings
 - Changing brake linings
 - Initiating lock angle sensor
 - Resetting maintenance messages
 - Changing language of on-board instruments
 - Training vehicle batteries
 - Setting Xenon headlights

- Expansion possible to include full TEXA car

diagnostics!

- Scope of delivery:

- AXONE S
- TEXA IDC4a Ⓢ TPS
- TEXA IDC4a Ⓢ FAST FIT
- TEXA TPMS Repair APP
- NAVIGATOR Nano S
- TPS-KEY
- USB power supply unit
- USB cable
- Operating instructions



02



01
RDKS aluminium valve
 With universal ball joint construction

- ▶ Item no. 9879-100-201
- ▶ Colour: silver, PU: 12

- ▶ Item no. 9879-100-202
- ▶ Colour: black, PU: 12

- ▶ Product description
- Valve type: Screw valve
- Attachment: Universal ball joint
- Length: 43mm
- Valve hole: Ø 11.3+0.4mm
- Colour: Anodized silver



02
Rubber valve
 Snap In

- ▶ Item no. 9879-100-203

- ▶ Product description
- Valve type: Snap-In
- Attachment: Clip pin
- Length: TR413
- Valve-hole diameter: 11.3+0.4mm
- Valve angle: 20°
- Max. speed: 210 km/h

03
Sensor valve
 Snap In

- ▶ Item no. 9879-100-102

- ▶ Product description
- Attachment: Clip pin
- Frequency: 434MHz
- Colour marking: Blue seal
- Sensor weight: 16 g



04
Tyrex
 Adhesive for tyre probes

- ▶ Item no. 9879-94-250
- ▶ Contents: 237 ml
- ▶ Packing unit: 1

05
Tyre probes
 Diam. 10 mm, PU: 10

- ▶ Item no. 9879-92-10

06
Tyre probes
 Diam. 4.5 mm, PU: 10

- ▶ Item no. 9879-92-04



07
Miller
 Diameter 6mm

- ▶ Item no. 9879-93-06

08
Tread roller
 for tyre probes

- ▶ Item no. 9879-91-2

09
Special rubber milling cutter
 For roughening the inner surface of tyres

- ▶ Item no. 9879-91-1





01

Tyre Repair Set

Tyron for HGVs

► Item no. 9879-971

► Product description

- 100% self-vulcanising bands
- Bands passed all TÜV endurance and high-speed test with overload
- Extremely tear-proof and shear resistant in tyres and steel belts thanks to leading-edge technology
- Can be used for straight and 45° punctures
- Suitable for all HGVs

- Set content:

- 25 x 6mm repair body (article no. 9879-974 - refill pack)
- 1 x pilot awl (article no. 9879-976)
- 1 x T-handle (article no. 9879-975)
- 1 x awl (article no. 9879-978)
- 1 x vulcanizing mass 25ml (article no. 9879-980)
- 1 x liquid patch 50ml (article no. 9879-979)
- 1 x scraper
- 1 x Allen key



01

02

Refill pack for Tyron repair kit

Tyron

► Item no. 9879-974

► Product description

- 100% self-vulcanising bands
- Bands passed all TÜV endurance and high-speed tests with overload
- Extremely tear-proof and shear resistant in tyres and steel belts thanks to leading-edge technology
- Can be used for straight and 45° punctures
- Suitable for all HGV tyres

- Contents:

- 25 x 6 mm repair body
- 1 x liquid patch 50ml

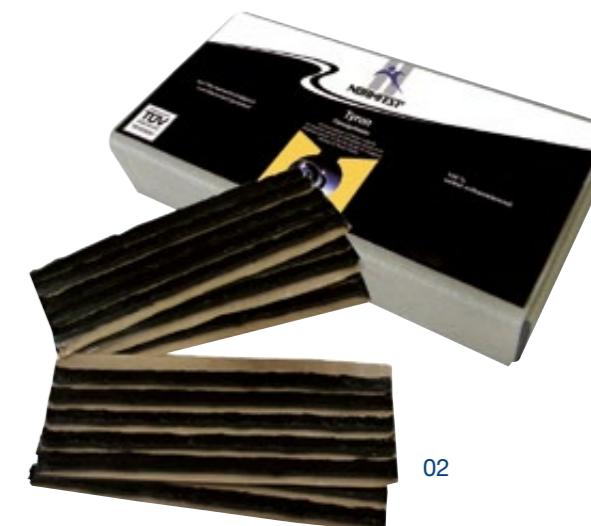

02

03

Tyron

Liquid patch

► Item no. 9879-979

► Contents: 50 ml

► Packing unit: 1



03

04

Awl

► Item no. 9879-978



04

05

Vulcanising substance

► Item no. 9879-980

► Contents: 25 ml

► Packing unit: 1



05

06

T-handle

► Item no. 9879-975



06

07

Penetrating awls

Length: 11.5 cm

► Item no. 9879-976



07

Painting



01

Multipurpose primer
1K-Multi-Connector

- ▶ Item no. 2893-900 Light grey
- ▶ Contents: 400 ml
- ▶ Packing unit: 12

- ▶ Item no. 2893-900-20 Dark grey
- ▶ Contents: 400 ml
- ▶ Packing unit: 12

- ▶ **Product description**
- Recoatable without sanding
- With fan spray head
- Substrates: Galvanised sheet steel and aluminium, plastic, wood, etc.
- Particularly suitable for protecting the edges of filled areas
- Ideal for all difficult substrates, also suitable for plastic and wood

02

Base primer
Baso Plus

- ▶ Item no. 2893-889 Light grey
- ▶ Contents: 400 ml
- ▶ Packing unit: 24

- ▶ **Product description**
- High filling properties
- Improved coverage due to increased number of pigments
- Temperature resistant up to 100°C
- Overpaintable with nitro, acrylic and water-based paints
- Fan spray head enables vertical and horizontal application



03

Thick film filler
One-component multi filler

- ▶ Item no. 2893-902
- ▶ Contents: 400 ml
- ▶ Packing unit: 10

- ▶ **Product description**
- High filling volume
- Easy to sand
- Quick drying
- With cone spray head

04

Primer filler
2-component epoxy primer filler

- ▶ Item no. 2800-760 Beige
- ▶ Contents: 400 ml
- ▶ Packing unit: 6

- ▶ **Product description**
- Gloss level: matt
- Colour: beige
- Long-lasting corrosion protection on all surfaces, e.g. zinc, aluminium, steel, etc.
- Proportion of solid particles: 50-53% by weight on diluted paint (without propellant gas)



01



02



03



04

01

Spray paint
Corona

- ▶ Item no. 2893-886
- ▶ Contents: 400 ml
- ▶ Packing unit: 6

Black



- ▶ Item no. 2893-887
- ▶ Contents: 400 ml
- ▶ Packing unit: 1

Silver



- ▶ **Product description**
- Heat resistant up to 650°C
- Weatherproof
- Resistant to wear and abrasion
- Free of heavy metals

02

Wheel rim silver
Silver Star

- ▶ Item no. 2893-883
- ▶ Contents: 400 ml
- ▶ Packing unit: 24

Silver



- ▶ **Product description**
- Good coverage
- Abrasion resistant
- Car-wash resistant
- Resistant to de-icing salt, stone impacts, etc.
- Free from heavy metals: No lead, cadmium or chromium

03

Black matt RAL 9005
Kroma

- ▶ Item no. 2893-884
- ▶ Contents: 400 ml
- ▶ Packing unit: 24

Black



- ▶ **Product description**
- Very good coverage
- Light resistant
- High proportion of solid matter
- Scratch resistant

04

glossy black
Spray paint

- ▶ Item no. 2893-885
- ▶ Contents: 400 ml
- ▶ Packing unit: 24

Black



- ▶ **Product description**
- this RAL spray paint is characterised by its fine flowing texture and good, colour-true coverage

01



02



03



04





01
2K-Clear varnish

- ▶ Item no. 2800-770
- ▶ Contents: 400 ml
- ▶ Packing unit: 6

- ▶ Product description
- Weatherproof
- Resistant to chemicals
- Resistant to petroleum
- Excellent filling properties

02
Spot blender paint

- ▶ Item no. 2800-780
- ▶ Contents: 400 ml
- ▶ Packing unit: 6

- ▶ Product description
- corrects paint transitions when filling paint



01



02

03
Silicone remover

- ▶ Item no. 2800-720
- ▶ Contents: 400 ml
- ▶ Packing unit: 6

- ▶ Product description
- Suitable for all cleaning tasks prior to and after painting, e.g. tar spatter, diesel exhaust particles, etc.

04
High-gloss clear varnish

- ▶ Item no. 2893-803
- ▶ Contents: 400 ml
- ▶ Packing unit: 6

- ▶ Technical specifications
- Protects new sheet metal against rusting
- Weldable
- Abrasion resistant after drying
- High corrosion protection
- High percentage of activesubstances



03



04

Aerosol can & accessories

- ▶ Item no. 2893-
- ▶ Aerosol can



- ▶ Item no. 2893-900-1
- ▶ Spray head (cone)

- ▶ Item no. 2893-900-3
- ▶ Fan nozzle



- ▶ Item no. 2893-900-2
- ▶ Pistol grip



TIP

RAL PAINT SPRAYS ARE RAPID-DRYING NITRO-COMBINATION PAINTS. THEY HAVE OUTSTANDING ADHESION PROPERTIES ON METAL AND VARIOUS PLASTICS*. * WITH CONNECTION TO 1K MULTI CONNECTOR ART. NO.: 2893-900

Paint spray

► Product description

- Extremely weather-resistant
- Quick-drying
- Excellent coverage
- High solid body content
- Resistant to scratches
- Free from heavy metals: no lead, cadmium or chromium

RAL 3000

Fire red, silk

► Item no. 2893-810-001

► Contents: 400 ml

► Packing unit: 6

► Suitable for:

Agricultural machinery / DAF
RAL 3000 = IC-096 / MB3524

RAL 9010

Pure white

► Item no. 2893-810-006

► Contents: 400 ml

► Packing unit: 6

► Suitable for:

Mercedes Benz / Iveco / Scania
Tractors / Agricultural machinery
MB box body
MAN driver's cab
RAL 9010 = Iveco IC-082

RAL 5010

Gentian blue

► Item no. 2893-810-009

► Contents: 400 ml

► Packing unit: 6

► Suitable for:

Mercedes Benz / Unimog
THW vehicles / containers
MAN driver's cab
German Railways / diggers
RAL 5010 = Iveco IC-071 / MB 5361

RAL 9005

Night black

► Item no. 2893-810-008

► Contents: 400 ml

► Packing unit: 6

► Suitable for:

Mercedes Benz / Iveco
MAN chassis / German army
RAL 9005 = Iveco IC-248 / MB 9040

RAL 3002

Carmine red

► Item no. 2893-810-007

► Contents: 400 ml

► Packing unit: 6

► Suitable for:

MAN driver's cab /
Iveco / DAF
RAL 3002 = Iveco IC 186 / MB 3535

RAL 9006

White aluminium

- ▶ Item no. 2893-820-005
- ▶ Contents: 400 ml
- ▶ Packing unit: 6

▶ Suitable for:
 Aluminium superstructures
 Aluminium rims
 German Railways
 Agricultural machinery / chassis

MB 7354

Argentite grey

- ▶ Item no. 2893-830-003
- ▶ Contents: 400 ml
- ▶ Packing unit: 6

▶ Suitable for:
 Mercedes Benz

RAL 9007

Grey aluminium

- ▶ Item no. 2893-870-001
- ▶ Contents: 400 ml
- ▶ Packing unit: 6

▶ Suitable for:
 Construction machinery

RAL 7012

Basalt grey

- ▶ Item no. 2893-870-002
- ▶ Contents: 400 ml
- ▶ Packing unit: 6

▶ Suitable for:
 Liebherr cranes
 Construction machinery

MB 9147

Arctic white

- ▶ Item no. 2893-830-008
- ▶ Contents: 400 ml
- ▶ Packing unit: 6

▶ Suitable for:
 Mercedes Benz

DB 7350

Nova grey

- ▶ Item no. 2893-830-009
- ▶ Contents: 400 ml
- ▶ Packing unit: 6

▶ Suitable for:
 Mercedes Benz
 DB 7350 = MB 7350

RAL 7021

Black-grey

- ▶ Item no. 2893-870-003
- ▶ Contents: 400 ml
- ▶ Packing unit: 6

▶ Suitable for:
 German army construction machinery

RAL 5002

Ultramarine

- ▶ Item no. 2893-870-004
- ▶ Contents: 400 ml
- ▶ Packing unit: 6

▶ Suitable for:
 THW (Technisches Hilfswerk, Federal Agency for
 Technical Relief)
 MAN chassis
 DAF

RAL 2011

Deep orange

- ▶ Item no. 2893-850-006
- ▶ Contents: 400 ml
- ▶ Packing unit: 6

▶ Suitable for:
 Mercedes Benz
 Municipal vehicles
 Construction machinery
 RAL 2011 = MB2603

RAL 9011

Graphite black

- ▶ Item no. 2893-860-002
- ▶ Contents: 400 ml
- ▶ Packing unit: 6

▶ Suitable for:
 MAN standard chassis colour
 Tractors / agricultural machinery

Komatsu yellow

Special colour

- ▶ Item no. 2893-870-005
- ▶ Contents: 400 ml
- ▶ Packing unit: 6

▶ Suitable for:
 Fork-lift truck

RAL 7024

Graphite grey

- ▶ Item no. 2893-870-006
- ▶ Contents: 400 ml
- ▶ Packing unit: 6

▶ Suitable for:
 Mercedes Benz

01

Scratch Off Ultra

Grinding paste, coarse

- ▶ Item no. 2000-341
- ▶ Contents: 1 kg
- ▶ Packing unit: 1

▶ **Technical specifications**

- Removes deep and heavy scratches
- Removes scratches completely (without fillers)
- Can be processed without water
- Long process time
- Leaves behind a unique deep gloss
- Silicone-free
-
- Rotary machines: 1,500 – 2,000 rpm
- Excenter machines: 1,700 – 2,200 rpm

Processing

- Spider sponge
- Polishing sponge, yellow
- Natural lambskin

Repolishing

- Microfibre cloth red
- Microfibre cloth blue



01

02

Scratch Off Medium

Grinding paste, medium

- ▶ Item no. 2000-342
- ▶ Contents: 1 kg
- ▶ Packing unit: 1

▶ **Technical specifications**

- Removes medium scratches
- Removes scratches completely (without fillers)
- Can be processed without water
- Long process time
- Leaves behind a unique high-gloss finish
- Silicone-free
-
- Rotary machines: 1,000 – 1,800 rpm
- Excenter machines: 1,700 – 2,200 rpm

Processing

- Spider sponge
- Polishing sponge, yellow
- Polishing sponge, orange

Repolishing

- Microfibre cloth red
- Microfibre cloth blue



02

03

Scratch Finish

Grinding paste, fine

- ▶ Item no. 2000-343
- ▶ Contents: 1 kg
- ▶ Packing unit: 1

▶ **Technical specifications**

- Removes light scratches
- Removes scratches completely (without filler)
- Long process time
- Leaves behind an excellent high gloss
- Can be processed by hand
- Silicone and wax-free
-
- Rotary machines: 800 – 1,500 rpm
- Excenter machines: 1,700 – 2,200 rpm

Processing

- Waffle sponge
- Polishing sponge, black
- Polishing sponge, orange



03



I LOVE THESE PRODUCTS



01

Perfect Gloss

High-gloss polish

- ▶ Item no. 2000-344-500
- ▶ Contents: 500 ml
- ▶ Packing unit: 1

- ▶ Item no. 2000-344-1
- ▶ Contents: 1 litre
- ▶ Packing unit: 1

- ▶ Item no. 2000-344-5
- ▶ Contents: 5 litres
- ▶ Packing unit: 1

▶ **Technical specifications**

- Removes holograms
- Leaves behind a long-lasting deep gloss
- Can be processed by hand
- Contains no volatile silicones
- Long-lasting protection
-
- Rotary machines: 800 – 1,500 rpm
- Excenter machines: 1,700 – 2,200 rpm

02

Push-pull closure

Colour: white

- ▶ Item no. 2000-356-2



Processing

Waffle sponge

Polishing sponge, black

Application sponge, black



03

Matting paste

Scraper

- ▶ Item no. 2000-314-1
- ▶ Contents: 1 litre
- ▶ Packing unit: 1

▶ **Product description**

- Conditions surfaces for areas to be painted in
- designed specifically for use with non-woven web
- increases grinding



01

03

01

Quick sealant
Speed-Gloss-Nano

- ▶ Item no. 2000-316-1
- ▶ Contents: 1 litre
- ▶ Packing unit: 1

- ▶ Item no. 2000-316-5
- ▶ Contents: 5 litres
- ▶ Packing unit: 1

▶ **Product description**

- Perfect shine effect
- Effortless polishing without leaving any sticky residue
- Suitable for cleaning without water
- Contains carnauba wax

Processing

Application sponge, black
Premium microfibre cloth, grey

02

Wax sealing
Speed-Wax

- ▶ Item no. 2000-330-1
- ▶ Contents: 1 kg
- ▶ Packing unit: 1

▶ **Product description**

- Natural carnauba wax, enriched with high-quality synthetic components
- For manual and machine application
- Permanent protection against the elements
- Long-lasting shine

- Rotary machines: 1,500 – 2,000 rpm
- Excenter machines: 1,700 – 2,200 rpm

Processing

Waffle sponge
Polishing sponge, black
Application sponge, black
Microfibre cloth, grey

03

Long-term sealant
Paint Guard

- ▶ Item no. 2000-331-500
- ▶ Contents: 500 ml
- ▶ Packing unit: 1

▶ **Technical specifications**

- Application by hand
- Extra UV protection for long-lasting maintenance of the paint layer
- Leaves behind a deep gloss
- Free of volatile silicones

Processing

Application sponge, black
Premium microfibre cloth, grey

04

Long-term surface-protection sealant
Pearl

- ▶ Item no. 2897-327
- ▶ Contents: 500 ml
- ▶ Packing unit: 6

▶ **Product description**

- Protective coating & gloss enhancer
- Increases scratch resistance and repels dirt
- Easy to apply and polish
- Takes just 10 minutes to cure
- Solvent free
- Contains silicone

Processing

Premium microfibre cloth, grey



01



02



03



04

01

**Fibreglass putty incl. hardener
(2893-139)**

Compound

- ▶ Item no. 2893-109-9
- ▶ Contents: 1.8 kg
- ▶ Packing unit: 4

Product description

- Outstanding direct adhesion on metal substrates
- Ideal for filling small surfaces, unevenness and grooves



01

02

**Multisoft filler with curing agent
(2893-139)**

Multi

- ▶ Item no. 2893-101-9
- ▶ Contents: 2 kg
- ▶ Packing unit: 4

Product description

- For filling large cavities
- Adheres to aluminium, plastics, steel and galvanised steel



02

03

**Universal filler with curing agent
(2893-139)**

Uni

- ▶ Item no. 2893-106-9
- ▶ Contents: 2 kg
- ▶ Packing unit: 4

Product description

- For filling small surfaces, unevenness and grooves
- Adheres to aluminium, plastics and steel (but not to galvanised steel)



03

04

**Fine filler with curing agent
(2893-139)**

Finish

- ▶ Item no. 2893-112-9
- ▶ Contents: 2 kg
- ▶ Packing unit: 4

Product description

- for filling small areas, ridges and grooves
- adheres to aluminium, plastics, steel and galvanised steel



04

05

**Aluminium filler with curing agent
(2893-139)**

Aluminium

- ▶ Item no. 2893-103-9
- ▶ Contents: 1.8 kg
- ▶ Packing unit: 4

Product description

- For filling large cavities as well as parts exposed to vibrations and oscillations
- Adheres to aluminium, plastics and galvanised steel



05



06

07

06

Body filler application set

- ▶ Item no. 8715-65-00

Product description

- 4 blades
- Acid-proof plastic grips

07

Plastic smoothing spatula

- ▶ Item no. 2893-164
- ▶ PU: 10

01

Velcro-type discs

Diameter 150 mm, Normfest, 15 perforated holes

Item no.	Graining
4515-010-0	100
4515-012-0	120
4515-015-0	150
4515-018-0	180
4515-022-0	220
4515-024-0	240
4515-032-0	320
4515-040	40
4515-040-0	400
4515-050-0	500
4515-060	60
4515-080	80

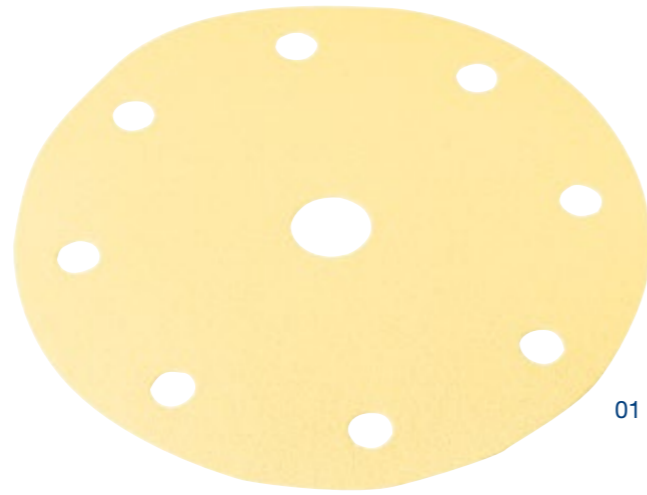

02

Hook & loop disks, 15 holes

Diameter 150 mm, Mirka Gold, 15 perforated holes

Item no.	Graining
4615-010-0	100
4615-012-0	120
4615-015-0	150
4615-018-0	180
4615-022-0	220
4615-024-0	240
4615-032-0	320
4615-040	40
4615-040-0	400
4615-050-0	500
4615-060	60
4615-080	80

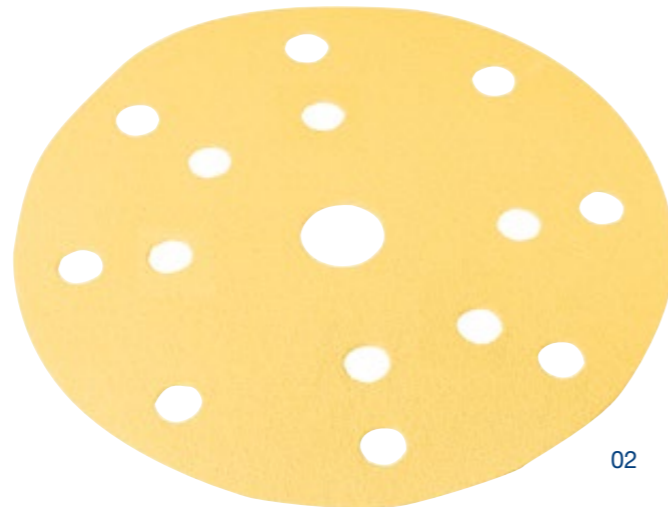

03

3in1 hook-and-loop polishing disks

▶ Item no. 4666-075-150

▶ Product description

- Consists of three different-sized hook-and-loop disks: 75mm, 120mm and 145 mm
- No more resetting of hook-and-loop holder disks to different sizes
- Suitable for all of our polishing sponges and sheepskins
- Provides high flexibility
- Has an M14 machine retainer



04

Polish Flex angle polisher

With powerful 1,400 Watt motor

▶ Item no. 8697-114-12

▶ Product description

- Max. polishing pad diameter: 200 mm
- Max. supporting disk Ø: 150 mm
- Idling speed: 380-2100 /min
- Power consumption: 1,400 W
- Power output: 880 Watt
- Tool retainer: M 14
- Dimensions (L x H): 402x117 mm
- Weight: 2.3 kg



- A handle is included in the package
- The associated replacement carbon brushes are available under article number 8697-114-120

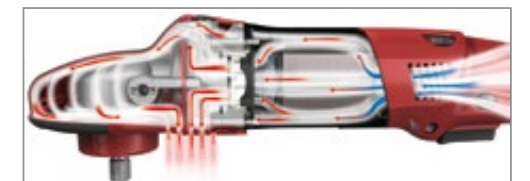

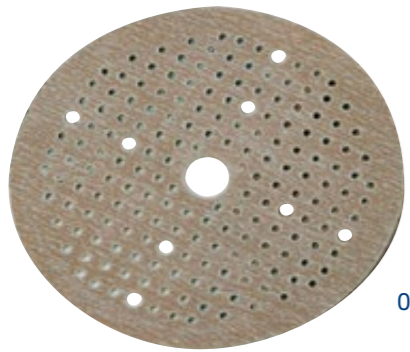

01

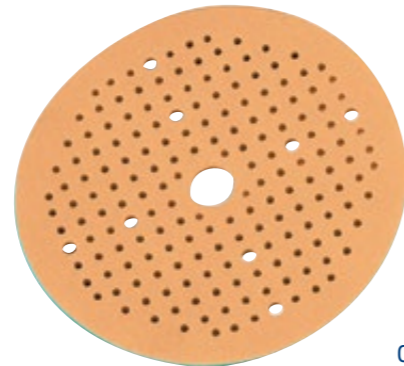

02

01
Velcro discs
 Diameter 150 mm Norton Multi-Air
 181 perforated holes Norgrip

Item no.	Graining
4651-080	80
4651-012-0	120
4651-015-0	150
4651-018-0	180
4651-022-0	220
4651-024-0	240
4651-032-0	320
4651-036-0	360
4651-040-0	400
4651-050-0	500
4651-060-0	600
4651-080-0	800

02
Velcro discs
 ø 150 mm – Norton Multi-Air
 perforated 181-fold – Soft

Item no.	Graining
4651-320	320
4651-400	400
4651-500	500
4651-800	800
4651-100-0	1000
4651-150-0	1500



03

03
Sanding Disc Velcro Norton Multi-Air
 Ø 150 mm

- ▶ Item no. 4666-150-3
- ▶ medium

- ▶ Item no. 4666-150-4
- ▶ soft



04

04
Sanding discs-Velcro Multi
 Diameter 150 mm, medium

▶ Item no. 4666-150-69

▶ Product description

Technical data:
 Thread 5/16"

- Sanding disc series E with dust extraction
- Extraction will all common hole patterns
- Contact surface for Velcro-type systems or self-adhesive sandpaper
- Micro Velcro type fastening



ABRALON - THE PERFECT FINISH FOR OLD AND NEW PAINTS!

For the surface structuring of paints, fillers, coating varnishes, clear varnishes, plastics and composite plastics.

Self-cleaning
 Water and air are set in motion by applying pressure to the Abralon disc.
 Thus circulating the grinding material.
 This results in the grinding debris and dust being transported into the foam underlay.

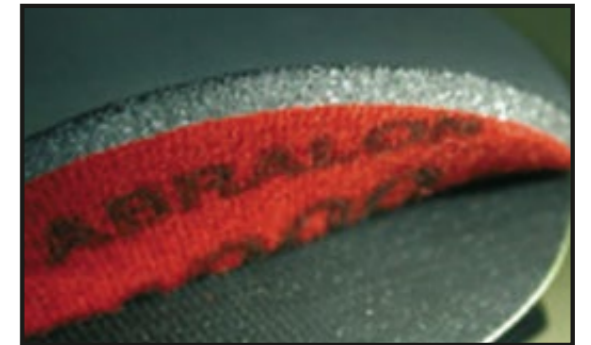

Item no.	Discs Ø	Graining
4587-360	150	360
4587-500	150	500
4587-600	150	600
4587-100-0	150	1000
4587-200-0	150	2000
4587-300-0	150	3000
4587-400-0	150	4000

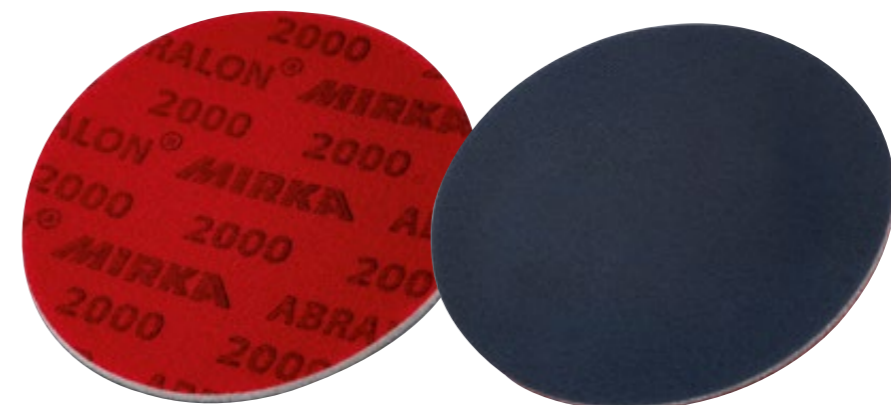
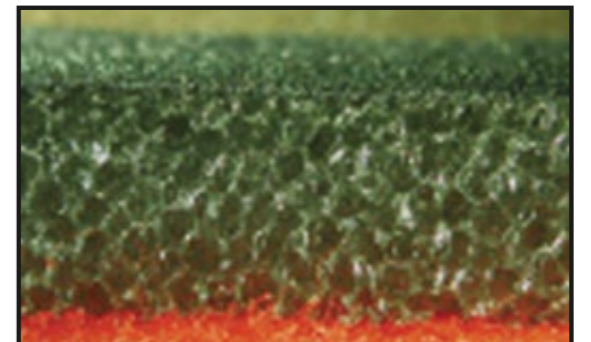

01

Vibrating grinding paper

Strips 115 x 280 mm,
yellow, perforated 10-fold

Item no.	Graining
4676-040	40
4676-060	60
4676-080	80
4676-010-0	100
4676-012-0	120
4676-018-0	180
4676-024-0	240

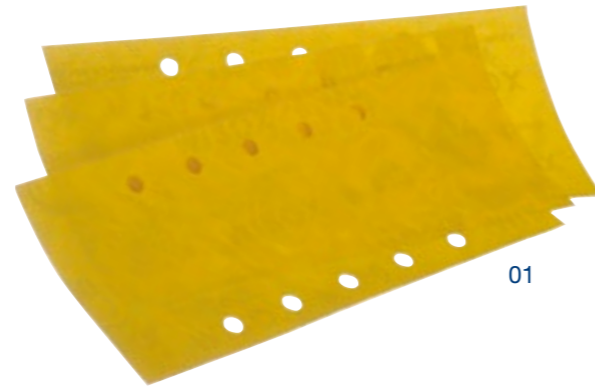

02

Vibrating grinding paper

Rolls each 50 m, width 115 mm,
yellow, non-perforated

Item no.	Graining
4677-040	40
4677-060	60
4677-080	80
4677-010-0	100
4677-012-0	120
4677-015-0	150
4677-018-0	180
4677-024-0	240



03

Vibrating grinding paper

Strips 115 x 280 mm,
yellow, non-perforated

Item no.	Graining
4676-40	40
4676-60	60
4676-80	80
4676-100	100
4676-120	120
4676-150	150
4676-180	180



04

Sanding strips

70 mm x 420 mm

► Product description

- For the quick stripping of old paint, sanding of body filler and removal of sharp edges and rough surfaces
- Excellent grain adhesion
- Long service life
- Flexible and robust

Item no.	Graining	Figure
4652-60	60	1
4652-80	80	2
4652-120	120	3



05

Sanding block

For sanding strips

► Item no. 4652-70-400

► Product description

- Ergonomically designed to reduce fatigue and physical stress
- The moulded plastic body ensures high resistance and longevity
- With valve for regulating the suction power and optimising the air/dust extraction



01

Sandpaper 3M 312Sheet 230 x 280 mm
waterproof

Item no.	Graining
4685-240	240
4685-280	280
4685-320	320
4685-400	400
4685-500	500
4685-600	600
4685-800	800
4685-100-0	1000
4685-120-0	1200
4685-150-0	1500
4685-200-0	2000



01

02

SandpaperSheet 230 x 280 mm
waterproof

Item no.	Graining
4673-80	80
4673-120	120
4673-180	180
4673-240	240
4673-320	320
4673-360	360
4673-400	400
4673-600	600
4673-800	800
4673-100-0	1000
4673-120-0	1200



02

03

Emery cloth, brown**25 m x 40 mm**

Item no.	Graining
4674-40-40	40
4674-40-60	60
4674-40-80	80
4674-40-100	100
4674-40-120	120

50 m x 50 mm

Item no.	Graining
4674-50-40	40
4674-50-60	60
4674-50-80	80
4674-50-100	100
4674-50-120	120
4674-50-180	180



03

04

Sand cloths

blue, sheet 230 x 280 mm

Item no.	Graining
4671-40	40
4671-60	60
4671-80	80
4671-120	120
4671-180	180

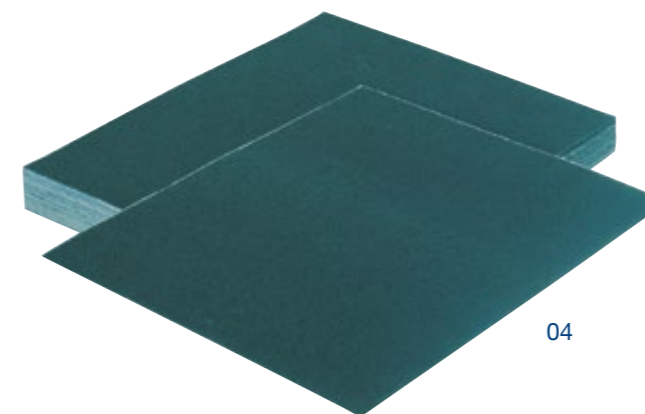

04

05

Abrasive fleece holder

empty

► Item no. 7100-002-07



05

01
Abrasive fleece
very fine, red

01 / 2

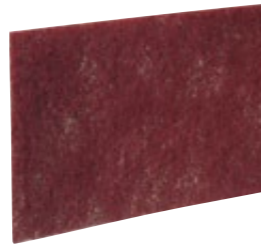

01 / 1



Item no.	Model	Figure
4585-451-10	Roll 115 mm x 10 m	1
4585-451	Pads 152 mm x 229 mm	2

02
Abrasive fleece
ultra fine, grey

02 / 2



02 / 1



Item no.	Model	Figure
4585-455-10	Roll 115 mm x 10 m	1
4585-455	Pads 152 mm x 229 mm	2

03
Soft abrasive paper roll
115 mm x 20 m

Item no.	Graining	Item no.	Graining
4586-150	150	4586-320	320
4586-180	180	4586-400	400
4586-220	220	4586-500	500
4586-240	240	4586-600	600
4586-280	280	4586-800	800



03

04
Carbon sanding block

- ▶ Item no. 4675-001-500
- ▶ 1,500 grit, yellow
- ▶ Item no. 4675-002-000
- ▶ 2,000 grit, green
- ▶ Item no. 4675-003-000
- ▶ 3,000 grit, red

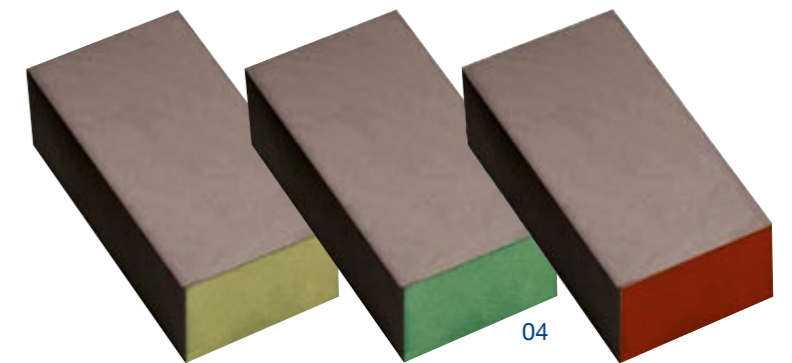

04

- ▶ Product description
- For removing scratches levelling unevenness



01

Contour tape

Rolls each 50 m

► **Item no. 4585-12**

► **Product description**

- for masking doors prior to painting
- leaves no residue
- weatherproof
- heat resistant approx. 120°C for 1 hour
- designed to suit every shape
- no creases and wrinkles
- Width: 19 mm
- Length: 50 m
- Colour: yellow



01

02

Contour tape

Rolls each 33 m

► **Item no. 4585-11**

► **Product description**

- Ideal for sticking down curves
- Particularly flexible
- Thermally stable to 70°C for one hour
- Solvent-proof and waterproof
- No edge warping when sticking curves
- Width: 6 mm
- Length: 33 m
- Colour: blue



02

03

Masking paper

Fully glued, length 300 m

► **Technical specifications**

- DIN-tested quantity
- High paint thickness
- Smooth on one side
- Guaranteed running length
- Caution: In the case of paints with a viscosity < 19 sec., carry out paint test in advance; if necessary, tape off edges with double-thickness of 20 cm paper.

Item no.	Model
7875-800-022	20 cm
7875-800-060	60 cm
7875-800-090	90 cm
7875-800-120	120 cm
7875-800-150	150 cm



03

04

Thermo-tape 110 – brown

Rolls each 50 m

► **Product description**

- Heat resistance
120°C > 30 minutes
100°C > 1 hour
- does not leave behind any adhesive residue on the vehicle body
 - perfectly suitable for wet grinding work
 - adhesive power works immediately
 - resistant to solvents

Item no.	Tape width
4993-119	18 mm
4993-125	24 mm
4993-130	30 mm
4993-138	36 mm
4993-150	48 mm



04

05

Thermo-tape 80 – white

Rolls each 50 m

► **Product description**

- Heat resistance
100°C > 30 minutes
80°C > 1 hour
- does not leave behind any adhesive residue on the vehicle body
 - perfectly suitable for wet grinding work
 - adhesive power works immediately
 - resistant to solvents

Item no.	Tape width
4993-519	19 mm
4993-525	25 mm
4993-530	30 mm
4993-538	38 mm
4993-550	50 mm



05

06

Foam Plus foam profile

self-adhesive

Item no.	Model
4582-13	50 m with 13 mm
4582-17	17 mm per 40 m



06

04

Stego tape

self-adhesive

Item no.	Insertion depth
4682-009	9 mm 10 m
4682-018	18 mm 10 m
4682-025	25 mm 10 m
4682-1	Abroller



07

01
Paint protective film

- ▶ Item no. 7875-917
- ▶ 4 x 200 m

- ▶ Product description
- Tensile strength lengthwise 24 N/mm²
- Tensile strength crosswise 17 N/mm²
- Exceptional paint adhesion
- Highly flexible and tear resistant
- Electrostatic charge attracts dust and dirt
- Microporous film, therefore 100% impervious to paint and water
- 15µ thick
- Very good cutting behaviour



01

02
Rim-varnish protective film
30 tear-off sheets

- ▶ Item no. 7875-918
- ▶ 130 cm x 130 cm

- ▶ Product description
- Original Wondermask® WPS
- Excellent protection from varnish haze
- Save significant time and work
- Save cover tape and cover paper
- Highly-flexible polyethylene mix, free of heavy metals
- Tear-resistant, lint-free, waterproof and microsealed
- No touching-up required
- Colour: Blue



02

03
Paint protective film
9 µm

- ▶ Item no. 7875-915
- ▶ 4 m x 300 mm

- ▶ Product description
- Statically charged
- Paint absorbent
- Overpaintable



03

04
Protective cap for paintwork
25 pcs.to tear off

- ▶ Item no. 7875-912
- ▶ 630 x 400 cm



04

05
Dust bonding cloth
Standard

Item no.	Dimensions	Sales unit
2893-165	45 x 75 cm	5 cloths



05

06
Quick filter screen

Item no.	Dimensions
2893-163	190 µm ultra fine
2893-162	280 µm fine
2893-161	125 µm ultra fine

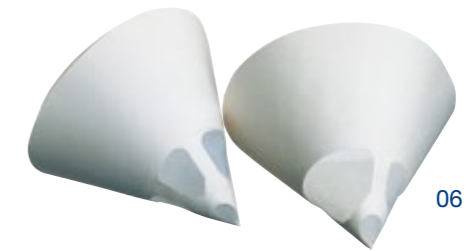

06

07
Dust bonding cloth
especially for water-based paints

Item no.	Dimensions	Sales unit
2893-166	38 x 43 cm	12 wipes



07

08
Paint mixing cup

Item no.	Model
2891-700-400	Colour mixing pots 400 ml
2891-700-650	Colour mixing pots 650 ml
2891-701-300	Colour mixing pots 1300 ml
2891-701-301	Cover for colour mixing pots 1300 ml
2891-702-230	Colour mixing pots 2230 ml
2891-702-231	Cover for colour mixing pots 2230 ml



08

01

Protective overall for paintwork

- ▶ Item no. 4899-500-3
- ▶ 52/54 L

- ▶ Item no. 4899-500-4
- ▶ 56/58 XL

- ▶ Item no. 4899-500-5
- ▶ 60/62 XXL

▶ **Product description**

- Certified to type 5 (particle-proof protective clothing) EN 149-1
- (limited spray-proof protective clothing)
- Protects against electrostatic charges in accordance with EN 1149-1
- Tyvek overall



01



02

Paint spraying set

In a plastic storage box

- ▶ Item no. 7200-002-000

▶ **Product description**

- content:
- 1 x reusable half mask
- 2 x gas filter class A2 against organic gases and vapours (art. no. 7315-000-100)
- 2 x pre-filter casing cover
- 20 x spray paint pre-filter (art. no. 7415-000-100)
- 1 x reusable plastic storage box



02

03

Fine dust filter mask

FFP3, with exhalation valve

- ▶ Item no. 7915-000-300

▶ **Product description**

- Standard EN 149:2001
- For use against solid and liquid aerosols
- Adjustable straps
- With exhalation valve
- With sealing lip
- Protection level FFP3
- Protection 30 times that of MAK value



03

04

Fine dust filter mask

FFP2, with exhalation valve

- ▶ Item no. 4899-12

▶ **Product description**

- Standard EN 149:2001
- Protection against fine dust, hazardous materials and carcinogenic dust
- With exhalation valve
- Protection level FFP2
- Protection 10 times that of MAK value



04

05

Fine dust filter mask

FFP1, without exhalation valve

- ▶ Item no. 4899-11

▶ **Product description**

- Standard EN 149:2001
- Protection against fine dust and non-toxic coarse particles
- Without exhalation valve
- Protection level FFP1
- Protection 30 times that of MAK value



05

01

Mini random orbital sander

30 mm

▶ Item no. 8696-1-81

▶ Item no. 8699-520-14

▶ Required compressed-air supply

▶ Product description

- No-load speed: 16,000 rpm
- Pad diameter: 50 mm Velcro-type model
- Stroke: 3.0 mm
- Weight: 0.7 kg
- Air pressure: 6.3 bar
- Air fitting: 1/4"
- Sound pressure: 80,4 dB/A
- Velcro-type pad: Incl. diameter 30 mm (4679-81-30)



02

Fineloc

With Velcro-type back Product description

- For sanding scratches and varnish runs



Holder for mini sanding disks with hook &

Diameter 30 mm

4679-90-91

Diameter 30 mm

4679-31-150 1.500

4679-31-200 2.000

Diameter 75 mm

4679-33-150 1.500

4679-33-200 2.000



03

Mini one-hand right angle grinder

Low-noise and vibration-free

▶ Item no. 8696-1-80

▶ Product description

- Compressed air fitting: 1/4"
- Sound pressure: 83 dB/A
- Air pressure: 6.3 bar
- Weight: 0.8 kg
- Speed: 18,000 rpm
- Chuck: 6 mm
- Average air consumption: 220 l/min



04

Adapter for 8696-1-80

▶ Item no. 4679-99-8



05

Required air connection 1/4"

▶ Item no. 8699-510-14



06

Normloc reception system

Made from a hard polyurethane supporting disc

▶ Item no. 4679-90-94

▶ Diameter 30 mm, max. rpm: 40,000

▶ Item no. 4679-90-92

▶ Diameter 50 mm, max. rpm: 30,000

▶ Item no. 4679-90-93

▶ Diameter 75 mm, max. rpm: 20,000

▶ Item no. 4679-99-6

▶ Ø 6 mm incl. mounting shank

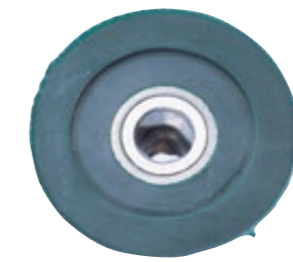

07

Lambswool cover, diameter 75 mm

POLISHLOC

▶ Item no. 4679-43



08

Velcro attachment

▶ Item no. 4679-91-93

▶ Ø 75 mm



01

Medium polishing sponge

Colour: orange

- ▶ Item no. 2000-352-75
- ▶ Diam. 75 mm, PU 4

- ▶ Item no. 2000-352-150
- ▶ Diam. 150 mm, PU 2

▶ Technical specifications

- Medium-hard polishing sponge
- Perfect for treating used and weathered paintwork
- Suitable for use with grinding and polishing pastes
- Polish and seal in one step



01



02

Hard polishing sponge

Colour: yellow

- ▶ Item no. 2000-351-75
- ▶ Diam. 75 mm, PU 4

- ▶ Item no. 2000-351-150
- ▶ Diam. 150 mm, PU 2

▶ Technical specifications

- High intake capacity for abrasive pastes
- Perfect for removing heavy scratches



02

03

Soft polishing sponge

Colour: black

- ▶ Item no. 2000-353-75
- ▶ Diam. 75 mm, PU 4

- ▶ Item no. 2000-353-150
- ▶ Diam. 150 mm, PU 2

▶ Technical specifications

- Perfect for applying fine polishing pastes and surface sealants
- Suitable for removing holograms



03

04

Spider polishing sponge

Colour: blue with excenter

- ▶ Item no. 2000-355-150
- ▶ Diam. 150 mm, PU 2

▶ Technical specifications

- Has fine cuts throughout so that the polish is absorbed into the sponge more effectively and therefore can be worked into the paint surface for longer
- Can withstand the high stroke of our excenter polishing machine very effectively
- Ideal for use with the polishing pastes Scratch Off Ultra and Scratch Off Medium



04



01

Waffle polishing sponge

Colour: black

- ▶ Item no. 2000-354-75
- ▶ Diam. 75 mm, PU 4

- ▶ Item no. 2000-354-150
- ▶ Diam. 150 mm, PU 2

▶ **Technical specifications**

- With integrated interface pad
- Extremely soft sponge
- Ideal for removing holograms



01

02

Lambskin

Colour: white

- ▶ Item no. 2000-350-75
- ▶ Diam. 75 mm, PU 4

- ▶ Item no. 2000-350-150
- ▶ Diam. 150 mm, PU 2

▶ **Product description**

- with integrated interface pad
- Extremely aggressive abrasive medium
- High intake capacity for abrasive pastes
- Perfect for removing heavy scratches, orange peel effect and dust inclusions



02

03

Velcro disc

- ▶ Item no. 4666-150-1
- ▶ Ø 150 mm

- ▶ Item no. 4666-075-1
- ▶ Ø 75 mm

▶ **Product description**

- With Velcro-type attachment for polishing sponges
- M14 mounting thread



03

04

Application sponge

black

- ▶ Item no. 2000-209-130
- ▶ Diam. 130 mm, PU 1

▶ **Product description**

- Ergonomic handle for easy and safe use with:
- Speed-Wax wax sealant (art. no. 2000-330-1)
- Speed Gloss Nano rapid sealant (art. no. 2000-316)



04

05

Stripe removal disc

Plastic eraser

ø 100 mm, width 15 mm
reception M10

- ▶ Item no. 4585-100-2
- ▶ With shaft for drill attachment



05

06

Decal remover ECO

Plastic eraser, diameter 88 mm, width 15 mm,
adaptor approx. 30 mm

- ▶ Item no. 4585-100-0
- ▶ Item no. 4585-100-3
- ▶ Drill adaptor for rubber disc



06

Vehicle parts passenger



01

ABA hose clamps

► Product description

- 50% greater tensile load compared to standard worm-drive hose clamps
- Weld- and rivet-free casing made from one piece
- Embossed band with high edges prevents damage to the hose wall
- Short casing saddle guarantees optimal positive locking
- Hexagon socket screw with slot

Item no.	Clamping range
5538-008-012	8 - 12 mm
5538-010-016	10 - 16 mm
5538-012-020	12 - 20 mm
5538-016-025	16 - 25 mm

Item no.	Clamping range
5538-020-032	20 - 32 mm
5538-025-040	25 - 40 mm
5538-032-050	32 - 50 mm



01

02

Worm drive hose clamps

► Product description

- Tape and casing: stainless steel 1.4016
- Screw: steel, galvanised, bandwidth 9 mm,
- Wrench size 7 mm

Item no.	Clamping range
5539-008-16	8 - 16 mm
5539-012-20	12 - 20 mm
5539-016-25	16 - 25 mm
5539-020-32	20 - 32 mm
5539-025-40	25 - 40 mm
5539-032-50	32 - 50 mm
5539-040-60	40 - 60 mm
5539-050-70	50 - 70 mm
5539-060-80	60 - 80 mm
5539-070-90	70 - 90 mm

Item no.	Clamping range
5539-080-100	80 - 100 mm
5539-090-110	90 - 110 mm
5539-100-120	100 - 120 mm
5539-110-130	110 - 130 mm
5539-120-140	120 - 140 mm
5539-160-180	160 - 180 mm
5539-140-160	140 - 160 mm
5539-130-150	130 - 150 mm
5539-150-170	150 - 170 mm



02

03

Hose clamps with worm drive and ondular washer

With integrated spring insert, entirely made from special steel, band width 12mm

► Product description

- Hex drive screw Spanner width 7 mm with slot
- Evens out fluctuating diameters
- Self-activating tensioning effect when hose relaxes
- Increased sealing reliability over wide temperature range

Item no.	Clamping range
5539-216-27	16 - 27 mm
5539-220-32	20 - 32 mm
5539-225-40	25 - 40 mm
5539-230-45	30 - 45 mm

Item no.	Clamping range
5539-235-50	35 - 50 mm
5539-240-60	40 - 60 mm
5539-250-70	50 - 70 mm
5539-260-80	60 - 80 mm



03

04

Breeze hose clamps

► Product description

- Band and casing: Special steel A2
- Screw: steel, galvanised, slotted hexagon screw
- Screw flight, bandwidth 14.3 mm
- Wrench size 8 mm

Item no.	Clamping range
5547-11-20	10 - 20 mm
5547-16-25	16 - 25 mm
5547-20-32	20 - 32 mm
5547-25-40	25 - 40 mm
5547-32-50	35 - 50 mm
5547-40-60	40 - 60 mm
5547-50-70	50 - 70 mm

Item no.	Clamping range
5547-60-80	60 - 80 mm
5547-70-90	70 - 90 mm
5547-80-100	80 - 100 mm
5547-90-110	90 - 110 mm
5547-100-120	100 - 120 mm
5547-110-130	110 - 130 mm
5547-120-140	120 - 140 mm



04

01

Single ear clamp

With rustproof insert ring



Item no.	Ø range	Band
5541-070	5,6 - 6,5 mm	6,4 mm
5541-087	7,0 - 8,2 mm	6,4 mm
5541-095	7,5 - 9,0 mm	7,4 mm
5541-010-5	8,5 - 10,0 mm	7, mm
5541-011-3	9,1 - 10,8 mm	7,4 mm
5541-012-3	9,8 - 11,8 mm	7,4 mm
5541-012-8	10,3 - 12,3 mm	7,4 mm
5541-013-3	10,6 - 12,6 mm	8,2 mm

Item no.	Ø range	Band
5541-013-8	11,1 - 13,1 mm	8,2 mm
5541-014-5	11,8 - 13,8 mm	8,2 mm
5541-015-0	12,3 - 14,3 mm	8,2 mm
5541-015-5	12,8 - 14,8 mm	8,2 mm
5541-016-0	13,1 - 15,3 mm	8,2 mm
5541-016-8	13,9 - 16,1 mm	8,2 mm
5541-017-5	14,6 - 16,8 mm	8,2 mm

02

Norma hose clamps with clamping jaw

All parts fully steel galvanised



Item no.	Ø range	Band
5540-6-7	6 mm	7 mm
5540-8-7	8 mm	7 mm
5540-11-9	10 mm	9 mm
5540-15-9	12 mm	9 mm
5540-16-9	13 mm	9 mm
5540-18-9	15 mm	9 mm
5540-20-9	16 mm	9 mm
5540-22-9	18 mm	9 mm

Item no.	Ø range	Band
5540-19-12	20 mm	9 mm
5540-25-15	22 mm	9 mm

03

Hose-clamp display

► Item no. 5539-077-777

► Product description

- Tape and casing: stainless steel
- Screw: steel, galvanised
- Bandwidth 9 mm
- Wrench size 7 mm



Item no.	Model	Quantity
5539-008-16	8 - 16 mm	220xx
5539-012-20	12 - 22 mm	220xx
5539-016-25	16 - 27 mm	100xx
5539-020-32	20 - 32 mm	100xx
5539-025-40	25 - 40 mm	100xx
5539-032-50	32 - 50 mm	100xx
5539-040-60	40 - 60 mm	100xx
5539-050-70	50 - 70 mm	100xx
5539-060-80	60 - 80 mm	100xx
5539-070-90	70 - 90 mm	100xx
5539-85	Hazet hexagon screwdriver	1 x
7100-000-1	Die plate, 500 x 450 mm	1 x
7100-000-3	Tool holder tilted 150 mm	12 x
7100-000-5	430 mm	2 x
7100-000-305	Universal gripper clamp 19 mm	1 x
Mounting material, screws and dowel pins		

04

Mini hose clamp

Bandwidth 5 mm, pre-assembled



Item no.	Clamping range
5541-7-11	7 - 11 mm
5541-9-16	9 - 14 mm
5541-10-19	10 - 19 mm

01

Clic-R brackets

rustproof chrome nickel steel

► **Product description**

- Suitable for fuel, cooling-, oil- and ventilation-circuits, shaft sleeve collars, LPG installation, all rubber and silicone hoses and shipping



01

Item no.	Closed Ø	Ø range	Band width	Colour
5537-066-70	7,0 mm	7,5 - 9,0 mm	6 mm	black
5537-066-90	9,0 mm	9,5 - 11,0 mm	6 mm	purple
5537-066-105	10,5 mm	11,0 - 12,5 mm	6 mm	yellow
5537-086-115	11,5 mm	12,0 - 13,5 mm	8 mm	purple
5537-086-120	12,0 mm	12,5 - 14,0 mm	8 mm	black
5537-086-125	12,5 mm	13,0 - 14,5 mm	8 mm	white
5537-086-130	13,0 mm	13,5 - 15,0 mm	8 mm	yellow
5537-086-140	14,0 mm	14,5 - 16,0 mm	8 mm	purple
5537-086-150	15,0 mm	15,5 - 17,0 mm	8 mm	white
5537-086-160	16,0 mm	16,0 - 18,0 mm	8 mm	green
5537-086-165	16,5 mm	17,0 - 19,0 mm	8 mm	purple
5537-086-185	18,5 mm	19,0 - 21,0 mm	8 mm	green

02

Crimping tool straight

For Clic-R brackets

► **Item no. 5537-1-75**

02

03

Crimping tool curved

For Clic-R brackets

► **Item no. 5537-2-75**

03

04

Universal U-bolt clamp

Item no.	Ø in mm
5883-6	42
5883-7	45
5883-8	48
5883-85	50
5883-9	52
5883-11	58
5883-12	60



04

05

Audi pipe clamp

Complete with screw, nut and lock washer

Item no.	Ø in mm
5883-080	45,5
5883-082	42,5
5883-084	53,5
5883-086-2	46,7
5883-086-3	48,5
5883-086-5	51,5
5883-086-7	54,5



05

06

Ford pipe clamp

M10, copper-plated lock nut, fully installed

Item no.	Ø in mm	Item no.	Ø in mm
5883-043	43	5883-055	55
5883-045	45	5883-058	58
5883-048	48	5883-060	60
5883-050	50	5883-062	62
5883-051	51	5883-064	64
5883-053	53		



06

01

Pipe support clamps

- ▶ **Product description**
- Full galvanized steel
- RSGU
- Rubberized



Item no.	Pipe diameter	Band	Hole Ø	Item no.	Pipe diameter	Band	Hole Ø
5542-6-12	6 mm	12 mm	5,3 mm	5542-15-20	15 mm	20 mm	8,4 mm
5542-6-15	6 mm	15 mm	6,4 mm	5542-18-15	18 mm	15 mm	6,4 mm
5542-8-12	8 mm	12 mm	5,3 mm	5542-20-15	20 mm	15 mm	6,4 mm
5542-8-15	8 mm	15 mm	6,4 mm	5542-20-20	20 mm	20 mm	8,4 mm
5542-8-20	8 mm	20 mm	8,4 mm	5542-25-12	25 mm	12 mm	5,3 mm
5542-9-12	9 mm	12 mm	5,3 mm	5542-25-15	25 mm	15 mm	6,4 mm
5542-10-12	10 mm	12 mm	5,3 mm	5542-25-20	25 mm	20 mm	8,4 mm
5542-10-15	10 mm	15 mm	6,4 mm	5542-30-15	30 mm	15 mm	6,4 mm
5542-12-12	12 mm	12 mm	5,3 mm	5542-30-20	30 mm	20 mm	8,4 mm
5542-12-15	12 mm	15 mm	6,4 mm	5542-35-15	35 mm	15 mm	6,4 mm
5542-15-12	15 mm	12 mm	5,3 mm	5542-40-20	40 mm	20 mm	8,4 mm
5542-15-15	15 mm	15 mm	6,4 mm	5542-50-15	50 mm	15 mm	6,4 mm

02

Wheel nuts Ford

OE no. 1007487, 6040307, 1447852
 M12 x 1.5 galvanised
 Quality 8 Wrench size 19

- ▶ **Item no. 6395-12-15**

OE no. 1470843
 M12 x 1.5 galvanised
 Quality 10, Wrench size 19

- ▶ **Item no. 6395-12-151**



03

Wheel nuts Mazda

Mazda, Mitsubishi, Toyota
 OE no. Mazda 0603-26-161
 OE no. Mitsubishi MA103087
 OE no. Toyota 90942-01001-83
 M12 x 1.5 yellow passivated
 Quality 8 Wrench size 21

- ▶ **Item no. 6395-012-15**

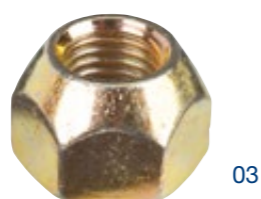

04

Wheel bolts Audi / VW

Volkswagen / Audi OE-no. 8D0
 601 139 D M14 x 1.5 x 25.5
 Geomet black FK 8.8 Wrench size 17

- ▶ **Item no. 6395-214-15**



05

Threaded inserts

Item no.	Internal thread model	External thread model
5660-3	M3 x 0,5	5,0 x 0,5
5660-4	M4 x 0,7	6,5 x 0,75
5660-5	M5 x 0,8	8,0 x 1,0
5660-6	M6 x 1,0	10,0 x 1,5
5660-8	M8 x 1,25	12,0 x 1,5
5660-10	M10 x 1,5	14,0 x 1,5
5660-12	M12 x 1,75	16,0 x 1,5
5660-14	M14 x 2,0	18,0 x 1,5



06

Inserting tool for manual assembly

Item no.	Internal thread model	External thread model
5660-103	M3 x 0,5	5,0 x 0,5
5660-104	M4 x 0,7	6,5 x 0,75
5660-105	M5 x 0,8	8,0 x 1
5660-106	M6 x 1,0	10,0 x 1,5
5660-108	M8 x 1,25	12,0 x 1,5
5660-110	M10 x 1,5	14,0 x 1,5
5660-112	M12 x 1,75	16,0 x 1,5
5660-114	M14 x 2,0	18 x 1,5



07

Spark plug inserts

Item no.	Model
5660-014	M14,1.25 / 9
5660-018	M18,1.50 / 9



08

Inserting tool for manual assembly

Item no.	Model
5660-114-1	M14 x 1.25
5660-118-1	M18 x 1.50



01

Petrol tube upper rubber

-40°C to +90°C, briefly +150°C



01

Item no.	Internal diameter	Wall thickness	Length
5897-055	5,5 mm	3,0 mm	20 m
5897-070	7,0 mm	3,0 mm	20 m
5897-075	7,5 mm	2,75 mm	20 m
5897-075-1	7,5 mm	3,0 mm	20 m
5897-095	9,5 mm	3,0 mm	20 m

02

Fuel hose

PVC compressor hose with textile, transparent



02

Item no.	Internal diameter	Wall thickness	Length
5895-45-80	4,0 mm	3 mm	15 m

03

Petrol tube NBR

-40°C to +125°C, briefly +150°C



03

Item no.	Internal diameter	Wall thickness	Length
5897-325	2,5 mm	1,75 mm	20 m
5897-333	3,3 mm	1,75 mm	20 m
5897-335	3,5 mm	2,25 mm	20 m
5897-337	3,7 mm	1,4 mm	20 m
5897-350	5,0 mm	2,5 mm	20 m
5897-380	8,0 mm	3,0 mm	20 m

04

Fuel tube ECO

-40°C to +90°C, briefly +110°C



04

Item no.	Internal diameter	Wall thickness	Length
5897-230	3,0 mm	7,0 mm	20 m
5897-235	3,5 mm	7,5 mm	20 m

05

Fuel hose

Yarn braided, temperature range -40°C to +110°C, suitable for biodiesel and biopetroleum, operating pressure 10 bar



05

Item no.	Internal diameter	Wall thickness	Length
5895-205	3,0 mm	7,5 mm	10 m
5895-206	3,5 mm	7,5 mm	10 m

06

Vacuum hose

Temperature resistant up to +110°C



06

Item no.	Internal diameter	Wall thickness	Length
5895-370	7,0 mm	3,0 mm	10 m
5895-393	9,3 mm	3,0 mm	10 m

07

Petrol tube yarn-woven

-40°C to +90°C, briefly +110°C



07

Item no.	Internal diameter	Wall thickness	Length
5897-132	3,2 mm	7,0 mm	20 m
5897-135	3,5 mm	7,5 mm	20 m
5897-145	4,5 mm	2,5 mm	20 m
5897-150	5,0 mm	10,0 mm	20 m
5897-155	5,5 mm	2,5 mm	20 m
5897-170	7,0 mm	2,5 mm	20 m
5897-175	7,5 mm	12,5 mm	20 m
5897-190	9,0 mm	2,5 mm	20 m
5897-195	9,5 mm	15,0 mm	20 m
5897-112-0	12,0 mm	3,0 mm	20 m

08

Universal petrol filter

KL 13

- ▶ Item no. 5895-000-145
- ▶ PU: 25



08



01 Exhaust repair paste
Asbestos-free

- ▶ Item no. 2893-148
- ▶ Contents: 150 g
- ▶ Packing unit: 12

- ▶ Product description
- Quick drying
- Highly viscous
- Asbestos-free



01

02 Exhaust repair paste
Asbestos-free

- ▶ Item no. 2893-149-1
- ▶ Contents: 150 g
- ▶ Packing unit: 12

- ▶ Product description
- Quick drying
- Highly viscous
- Asbestos-free
- For sealing junctions



02

03 Slotted round nuts
Thermag, DIN 14440,
normal width across flats



03

Item no.	Thread	Width across flats
6365-2	M8	13
6365-3	M10	17

04 Slotted round nuts
Thermag, DIN 14441,
reduced width across flats



04

Item no.	Thread	Width across flats
6366-1	M6	9
6366-2	M8	12
6366-3	M10	14
6366-7	M10 x 1,25	14
6366-8	M8 X 1	12

05 Exhaust pipe nuts
With flange 17 mm
Quality 8, copper-plated
Opel no. 8-54-906
Height 10 mm



05

Item no.	Thread	Width across flats
6365-6	M8	13 mm

06 Exhaust pipe nuts
With flange 21 mm
Self-locking
Quality 8, copper-plated
Opel no. 8-54-976
Height 10 mm



06

Item no.	Thread	Width across flats
6365-65	M10	15 mm

07 Exhaust pipe nuts
With flange 17 mm
Self-locking
Quality 8, copper-plated
Opel no. 20-66-156
Height 8 mm

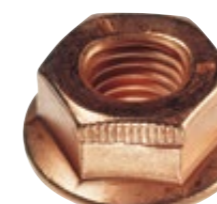

07

Item no.	Thread	Width across flats
6365-61	M8	13 mm

08 Exhaust pipe nuts
With flange 17 mm
Quality 8, copper-plated
BMW no. 1162-1711-954
Height 8.6 mm



08

Item no.	Thread	Width across flats
6365-8	M8	12 mm



01
Universal joint gaiters Set

suitable for nearly every passenger car

Item no.	Ø in mm
5884-900	95
5884-901	105



01

02

Drive shaft joint grease

Greasor

- ▶ Item no. 5884-950
- ▶ Contents: 90 ml
- ▶ Packing unit: 1

▶ **Product description**

- High quality lithium soap grease with MoS2 as solid lubricant
- Specially designed for highly loaded constant velocity joints and is ideal for greasing and lubricating slip and fixed joints as well as ball bearings.



02

03

Clamp for axel boot

Item no.	Ø in mm
5550-884-31	27,6 - 30,8
5550-884-33	29,9 - 33,1
5550-884-35	31,4 - 34,6
5550-884-88	84,3 - 87,5
5550-884-97	93,3 - 96,5



03

04

Steel cable ties

Item no.	Band	Length
5884-909	6,0 mm	380 mm



04

05

Steel cable ties

Item no.	Band	Length
5550-46-127	4,6 mm	127 mm
5550-46-201	4,6 mm	201 mm
5550-46-360	4,6 mm	360 mm
5550-79-201	7,9 mm	201 mm
5550-79-362	7,9 mm	362 mm



05



01
License plate screw
Plastic PA 6.6



Item no.	Colour	Model
6210-078	white	6 x 20 mm

06
Rubber gaskets



Item no.	Model
6422-65-17	6.5 x 17 x 2 mm
6422-65-20	6.5 x 20 x 3 mm

07
Plastic distance washers



Item no.	Model
6421-06-18	18 x 7 x 6 mm

02
License plate screw
Head: V shaped, galvanised steel



Item no.	Model	Figure
6210-41	5 x 15 mm	02 / 2
6210-42	5 x 20 mm	02 / 2
6210-46	6 x 20 mm	02 / 2
6246-6-20	6 x 20 mm	02 / 1

03
License plate screw
Plastic PA 6.6, completely assembled



Item no.	Colour	Model
6210-78	white	6 x 20 mm

08
Sheet metal screw with gripping groove for decorative caps
for the attachment of license plates, thread according to DIN 7971, steel, quality 4.8, brightly galvanised

► Item no. 6103



09
License plate screw
with drill bit
drill and screw in one step
high level of corrosion prevention

► 6211-0



04
Decorative caps
For 6210, 6246

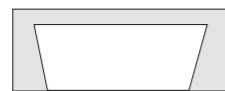

Item no.	Colour
6590-132-2	white
6590-132-3	black

05
Decorative caps
for item no. 6103-

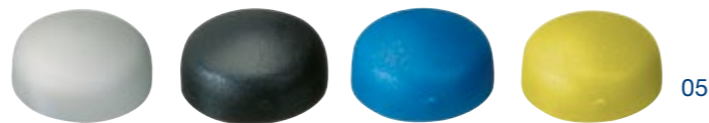

Item no.	Colour
6590-103	white
6590-10-6	black
6590-109	blue
6590-100	yellow

10
License plate screw
Opel, fixed grommet, galvanised

► Item no. 6103-0



11
license plate screw A2
high-grade steel, DIN 7981

► Item no. 6119

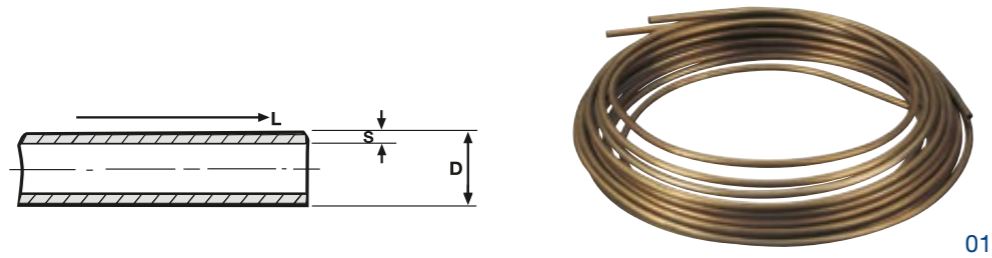

01

Brake line

Item no.	Model	D	S	Length (L)
5885-090	Copper/Nickel alloy	4,75 mm	0,71 mm	5 m
5885-091	Copper/Nickel alloy	6,00 mm	0,71 mm	10 m

02

Brake line extension

Steel



Item no.	d1	d2	s x tl	Figure
5885-200	M10 x 1, Konus	Ø 3,5	14 x 24,0	02 / 2
5885-201	M12 x 1	Ø 4,0	17 x 29,0	02 / 2
5885-202	M10 x 1	Ø 3,2	11 x 28,0	02 / 1
5885-203	3/8" x 24UNF	Ø 3,1	14 x 33,2	02 / 2
5885-204	3/8" x 24UNF	Ø 3,2	11 x 28,0	02 / 1

03

Brake line nipple steel

Item no.	d2 Ø	Vehicle type
5885-100	5,0	Alfa, Audi, BMW, Citroen, Dacia, Fiat, Ford, Honda, Mitsubishi, Mercedes, Nissan, Opel, Peugeot, Renault, Rover, Saab, Seat, Skoda, Talbot, Volvo, VW, Zastava
5885-101	5,0	Alfa, Audi, Citroen, Fiat, Ford, Honda, Opel, Peugeot, Renault, Rover, Seat, Skoda, Saab, Volvo, VW
5885-102	5,0	Fiat
5885-103	5,0	Daihatsu, Hyundai, Nissan, Opel, Skoda, Toyota, Vauxhall, VW
5885-104	5,0	Toyota VW
5885-106	5,0	Bedford, Renault, Rover, Saab, Talbot, Vauxhall, Volvo
5885-109	5,0	Autobianchi, Dacia, Fiat, Lada, Lancia, Zastava
5885-110	5,0	Mazda
5885-111	5,0	Peugeot
5885-112	5,0	Daihatsu, Honda, Hyundai, Isuzu, Mazda, Mitsubishi, Nissan, Opel, Suzuki, Toyota, VW
5885-113	6,5	



01
Lubricator nipple
DIN 71412, H 1

Item no.	Model
6986-40	M6 x 1
6986-41	M8 x 1
6986-42	M10 x 1



02
Lubricator nipple
DIN 71412, H2

Item no.	Model
6986-50	M6 x 1
6986-51	M8 x 1
6986-52	M10 x 1



03
Lubricator nipple
DIN 71412, H 3

Item no.	Model
6986-60	M6 x 1
6986-61	M8 x 1
6986-62	M10 x 1



04
Angle joints
DIN 71802, galvanised

Item no.	1 mm x 2 mm	Type
6268-208-16	13 x 8	A
6268-508-16	13 x 8	AS

A = standard
AS = with lock ring

05

Assortment of clamping sleeves

DIN 1481, blank

► Item no. 1957-476

Contents: 985 parts

100 x 2 X 20	(art. no. 6476-2-20)
100 x 2 X 30	(art. no. 6476-2-30)
100 x 3 X 20	(art. no. 6476-3-20)
100 x 3 X 40	(art. no. 6476-3-40)
100 x 4 X 40	(art. no. 6476-4-40)
100 x 4 X 60	(art. no. 6476-4-60)
50 x 5 X 30	(art. no. 6476-5-30)
50 x 5 X 40	(art. no. 6476-5-40)
50 x 5 X 60	(art. no. 6476-5-60)
50 x 6 X 40	(art. no. 6476-6-40)
50 x 6 X 50	(art. no. 6476-6-50)
50 x 6 X 60	(art. no. 6476-6-60)
25 x 8 X 40	(art. no. 6476-8-40)
25 x 8 X 50	(art. no. 6476-8-50)
25 x 8 X 60	(art. no. 6476-8-60)
10 x 10 X 60	(art. no. 6476-10-60)



05



06

Clamping sleeves

DIN 1481blank

Item no.	Model	Item no.	Model
6476-2-20	2 x 20	6476-5-60	5 x 60
6476-2-30	2 x 30	6476-6-40	6 x 40
6476-3-20	3 x 20	6476-6-50	6 x 50
6476-3-40	3 x 40	6476-6-60	6 x 60
6476-4-40	4 x 40	6476-8-40	8 x 40
6476-4-60	4 x 60	6476-8-50	8 x 50
6476-5-30	5 x 30	6476-8-60	8 x 60
6476-5-40	5 x 40	6476-10-60	10 x 60



01

**01
Hose connector
straight**

Item no.	For hose Ø
5896-103	3 mm
5896-104	4 mm
5896-105	5 mm
5896-106	6 mm
5896-108	8 mm
5896-110	10 mm



02

**02
T-shaped hose connector**

Item no.	For hose Ø
5896-203	3 mm
5896-204	4 mm
5896-205	5 mm
5896-206	6 mm
5896-208	8 mm
5896-210	10 mm



03

**03
Angled hose connector**

Item no.	For hose Ø
5896-303	3 mm
5896-304	4 mm
5896-305	5 mm
5896-306	6 mm

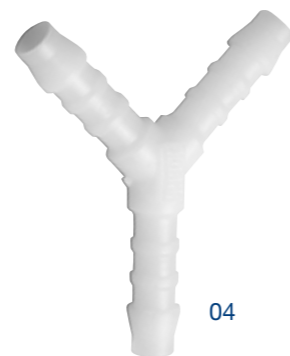

04

**04
Y-shaped hose connector**

Item no.	For hose Ø
5896-403	3 mm
5896-404	4 mm
5896-405	5 mm
5896-406	6 mm
5896-408	8 mm
5896-410	10 mm

05

Assortment of plastic hose connectors

► Item no. 1957-896

Contents: 160 parts

10 x Straight hose connector 3mm	(art. no. 5896-103)
10 x Straight hose connector 4mm	(art. no. 5896-104)
10 x Straight hose connector 5mm	(art. no. 5896-105)
10 x Straight hose connector 6mm	(art. no. 5896-106)
10 x T-hose connector 3mm	(art. no. 5896-203)
10 x T-hose connector 4mm	(art. no. 5896-204)
10 x T-hose connector 5mm	(art. no. 5896-205)
10 x T-hose connector 6mm	(art. no. 5896-206)
10 x Angled hose connector 3mm	(art. no. 5896-303)
10 x Angled hose connector 4mm	(art. no. 5896-304)
10 x Angled hose connector 5mm	(art. no. 5896-305)
10 x Angled hose connector 6mm	(art. no. 5896-306)
10 x Y-hose connector 3mm	(art. no. 5896-403)
10 x Y-hose connector 4mm	(art. no. 5896-404)
10 x Y-hose connector 5mm	(art. no. 5896-405)
10 x Y-hose connector 6mm	(art. no. 5896-406)



05

06

PVC hose, transparent



06

Item no.	Inner ø mm	Wall thickness mm	Roll length m
5895-3	3,0	1,0	15
5895-4	4,0	1,0	15
5895-5	5,0	1,2	15
5895-6	6,0	1,2	15
5895-8	8,0	1,5	15
5895-10	10,0	1,5	10
5895-12	12,0	2,0	10

Commercial vehicles



01

Multi-chamber light MAN

LC8 with rear reflector, blue lighting panel and side connector plug AMP 1.5

Item no.

1006-47-11	left with license plate lighting
1006-47-12	right without license plate lighting
1006-47-111	Light lens left red/blue
1006-47-121	Light lens right red/blue
1006-47-112	Light lens left red/white
1006-47-122	Light lens right red/white

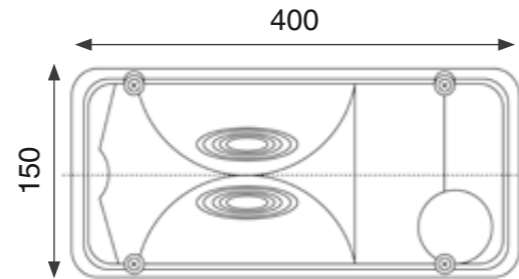

01

02

6-chamber light MAN

Centre, with MAN compact plug, can be retrofitted to LED technology with Glowpoint base (3720-075-15)

Item no.

1006-36-292	Lighting panel with rear reflector
1006-41-11	Right, with MAN compact plug without number plate light
1006-41-12	Left, with number plate light and with MAN compact plug

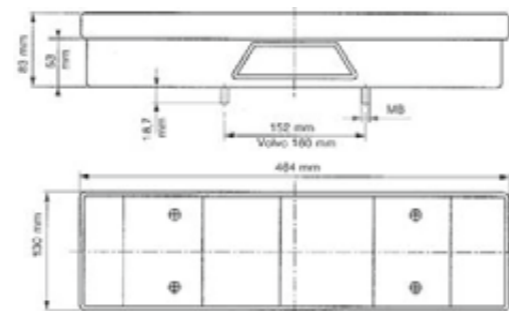

02

03

6-chamber light

Mercedes-Benz Actros with side compact plug, can be retrofitted to LED technology with Glowpoint base (3720-075-15)

Item no.

1006-37-11	Left, with number plate light
1006-37-12	Right, without number plate light
1006-36-191	Lighting panel left
1006-36-192	Lighting panel right

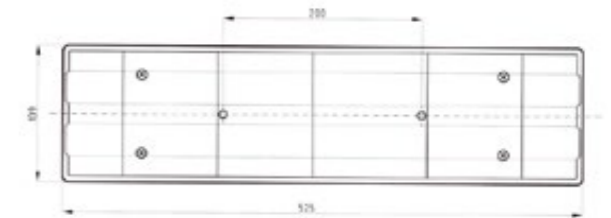

03

04

Light lens with rear reflector for 6-chamber TGA lights

Item no.

1006-36-292	Lighting panel with rear reflector
-------------	------------------------------------

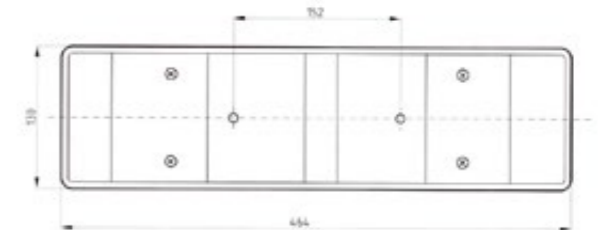

04

01

Multi-chamber light (Europoint II)

With 7-pin central plug

Item no.

1006-39-61	left
1006-39-71	right
1006-39-81	Lighting panel



01

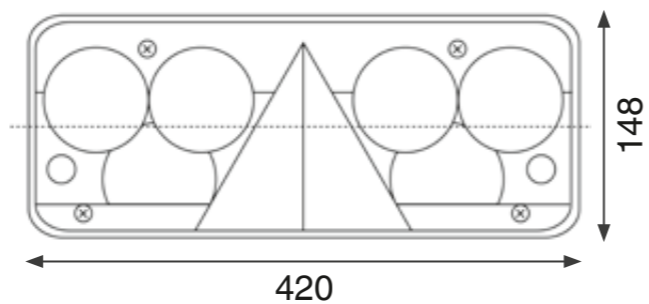

02

Multi-chamber light

Mercedes-Benz Atego with plug connection on rear of housing

Item no.

1006-46-21	Right/Left without number plate light
1006-46-22	left with license plate lighting
1006-46-29	Lighting panel right/left



02

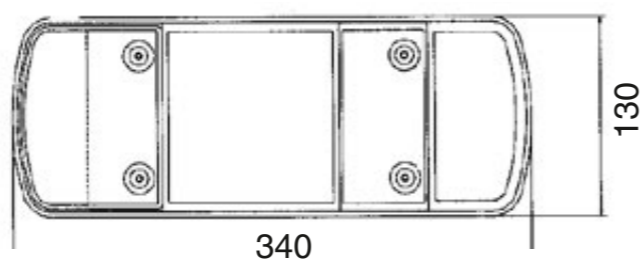

03

5-chamber light

Universal, with gland

Item no.

1006-35-11	left with license plate lighting
1006-35-12	Left without number plate light
1006-35-13	right without license plate lighting
1006-35-19	Light lens for 5-chamber light



03

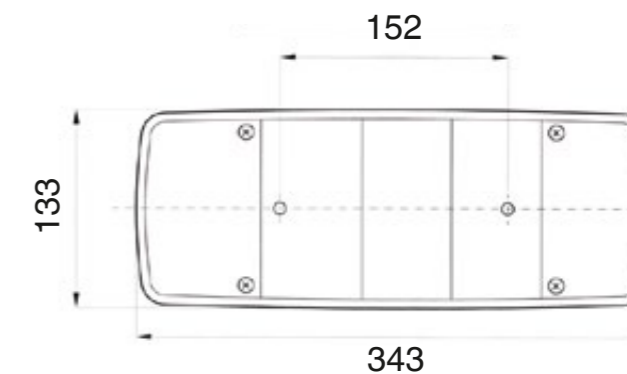

01

Light lens for 3-chamber light

Universal, with gland

Item no.

1006-33-19	Lighting panel
------------	----------------



01

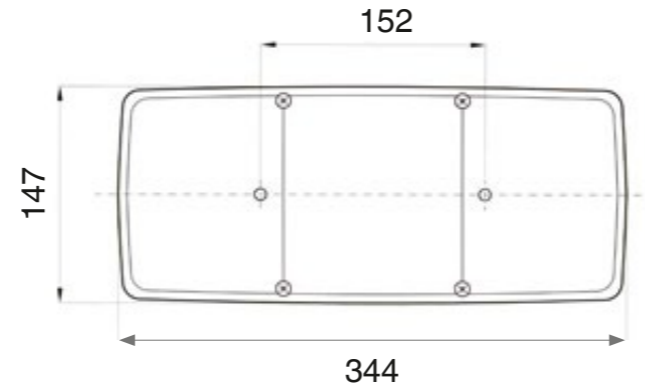

02

4-chamber light

MB-Krone-Schmitz

Item no.

1006-34-11	Left with rear fog light
1006-34-12	Right with reversing light



02



03

Multi-chamber light (Europoint I)

Item no.

1006-39-11	Left with number plate light (gland seal)
1006-39-21	right (gland)
1006-39-31	Left with compact plug and number plate light
1006-39-41	right with compact plug
1006-39-51	Light lens for multi-chamber light Europoint



03

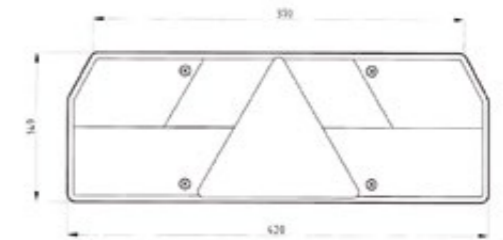

04

Multi-repair set plug

7 pole

► **Product description**

- These 7-pin compact plugs are required for mounting Europoint I and II rear lights
- and fit both the left (yellow) and right (green) sides
- Required for the following multi-chamber lights:
Europoint I multi-chamber light (article no.: 1006-39-31, 1006-39-41)
Europoint II multi-chamber light (article no.: 1006-39-61, 1006-39-71)

Item no.

1006-46-30	Left
1006-46-31	Right



04



01

Multi-chamber light, Europoint II

Schmitz design, ADR tested

► **Product description**

- Clear glass appearance, with integrated triangular rear reflector
- Brake light, indicator light, rear fog light, reversing light with bulbs
- Tail light fitted with LED bulb
- All functions also available with LED technology
- 4 x 2-pin connections on the rear for additional functions (ASS1 / ASS2 plug)
- 1 x 7-pin central plug, central (ASS2 plug)

- Dimensions:
- W = 420 mm
- H = 148mm
- D = 85mm



01

Item no.

1006-48-11	Left
1006-48-12	Right

02

LED five-chamber light round 12/24V

Rear positioning light / brake light / rear indicator light / reversing light / fog light

► **Item no. 1004-70-5**

► **Technical specifications**

- Unique design
- High-performance LED technology
- Functions: light, brake light, indicator light, rear fog light, reversing light
- Operating voltage from 9-36 V
- With E-test mark
- Diameter 140 mm
- Height 25 mm
- Two M6 stay bolts on the reverse for fastening (drill hole spacing 45 mm)
- 2-m-long connecting cable



02

03

LED three-chamber light round 12/24V

Rear positioning light / brake light / rear indicator light

► **Item no. 1004-70-4**

► **Technical specifications**

- Unique design
- High-performance LED technology
- Functions: light, brake light, indicator light
- Operating voltage from 9-36 V
- With E-test mark
- Diameter 140 mm
- Height 25 mm
- Two M6 stay bolts on the reverse for fastening (drill hole spacing 45 mm)
- 2-m-long connecting cable



03

01

LED chambered lighting unit

Universal, for trailers, combination light, rear positioning light, fog light, reversing light, brake light, rear indicator light, reflector

Item no.

1004-80-1	right
1004-80-2	left



02

LED multi-chamber light

Universal

Item no.

1004-70-1	Rear fog light
1004-70-2	Back-up light
1004-70-3	Multifunctional light (indicator, brake light, rear light) (Blinker, Bremslicht, Schlusslicht)

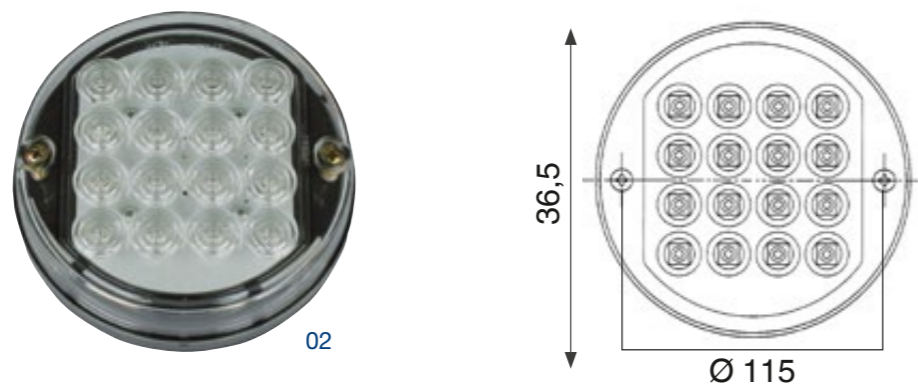

03

License plate lighting

12-24 V, black

► Item no. 1006-10-22

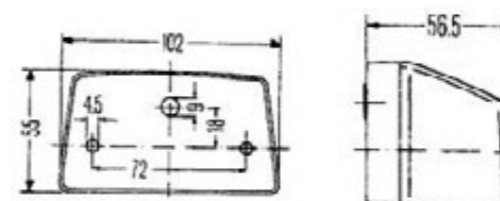

04

LED license plate lighting

12-24 V, right and left

► Item no. 1004-60-2

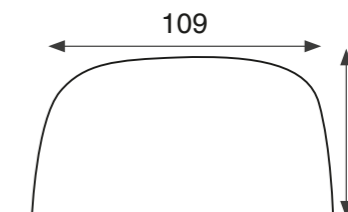

05

LED license plate lighting

24 V

► Item no. 1004-60-1

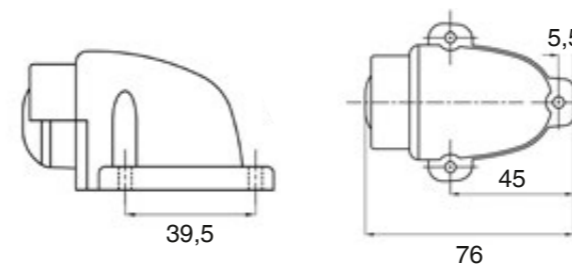

06

LED number-plate light, 12V and 24V

for cars and commercial vehicles

► Item no. 1006-10-23

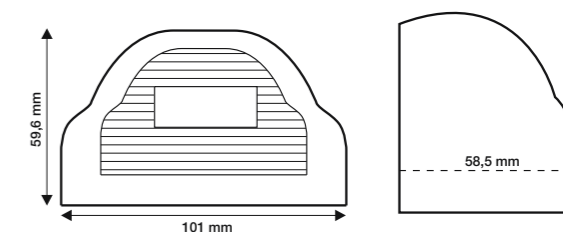

01

LED work light, 5400 Lm

Suitable for 12V - 24V

► Item no. 1004-90-8

► Product description

- Fitted with 12 high-performance LEDs
- Light intensity: approx. 5400 Lumen
- Diffuse light
- Operating voltage: 11.5 V to 33 V
- Pre-cabled (approx. 2.5 m supply cable with 2x1.5mm² black/plus white/minus)
- Water-resistant IP66 IP68
- W / H / D 110 x 159 x 85mm
-
- Impact-resistant aluminium housing
- Low heat build-up
- Includes universal stainless-steel mounting bracket
- No approval required, has E-test mark
- For cars and commercial vehicles



02

H3 work light 12V/24V

With glass diffusion lens to illuminate large areas, u-shaped bracket

► Item no. 1006-38-3

► Product description

- No cables
- No bulbs
- With glass diffusion lens
- For large-scale, intensive near-field illumination
- U-bolt fastening
- Small, compact structure
- PK 22s / H3
- 12/24 Volt
- Connection on the rear of the housing
- ADR inspected, IP54

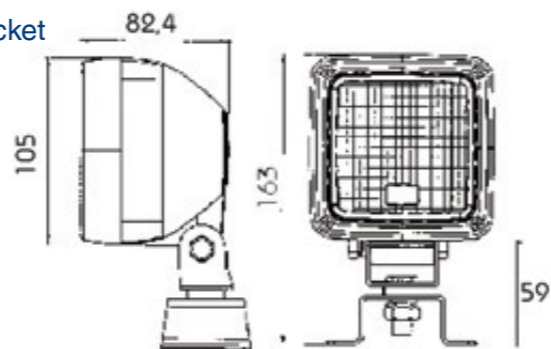

03

LED worklamp, 12/24 Volt

Operating voltage: 10 V to 36 V

► Item no. 1004-90-6

► Product description

- Fitted with 12 genuine Osram high-performance LEDs
- Light intensity: 2,400 lumen
- Diffuse light
- Power input: 17 W
- Impact-resistant PP plastic housing
- Low heat build-up
- Water-resistant IP66 IP68
- Pre-cabled (approx. 2.5 m supply cable)
- Includes universal mounting bracket
- No approval required, has E-test mark
- For cars and commercial vehicles
-
- Height of lamp body: 101 mm
- Width of lamp body: 101 mm
- Height including foot: 160 mm
- Width including foot: 121 mm
- Diameter of foot: 121 mm

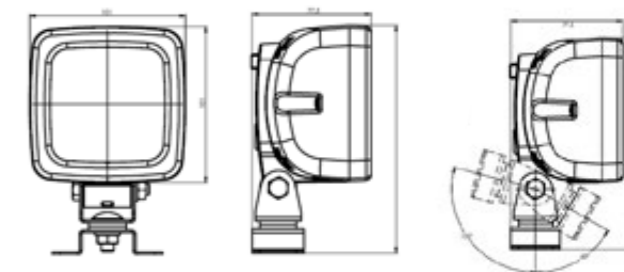

04

LED worklamp, 12V/24V

Operating voltage: 10 V to 36 V

► Item no. 1004-90-7

► Product description

- No approval required, has E-test mark
- Fitted with 12 genuine Osram high-performance LEDs
- Light intensity: 2,400 lumen
- Diffuse light
- Power input: 17 W
- Impact-resistant PP plastic housing
- Low heat build-up
- Water-resistant IP66 IP68
- Pre-cabled (approx. 2.5 m supply cable)
- Includes universal mounting bracket
-
- Height of lamp body: 101 mm
- Width of lamp body: 101 mm
- Height including foot: 160 mm
- Width including foot: 121 mm
- Diameter of foot: 121 mm

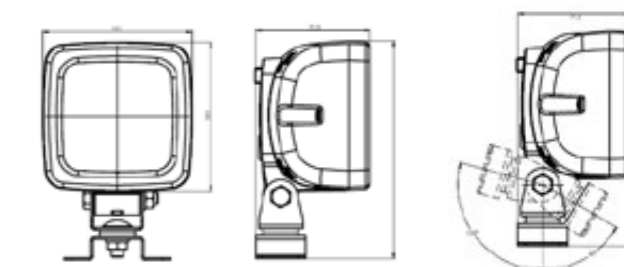

01

LED profile light

24V/0.8W

▶ Item no. 1006-10-33

▶ Product description

- Cable length 0.5 m
- With reflector
- White
- 90° cable connection in hot-melt method
- ADR-tested, IP 54
- 24 Volt
- 0.8 Watt

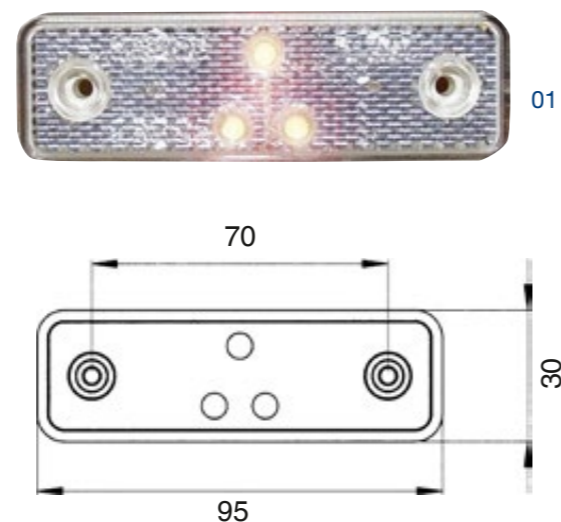

02

Outline marker lighting

flexible holder

▶ Item no. 1006-10-20

▶ Product description

- Spacing for M5/15 mm
- With bracket
- Light lens red/white

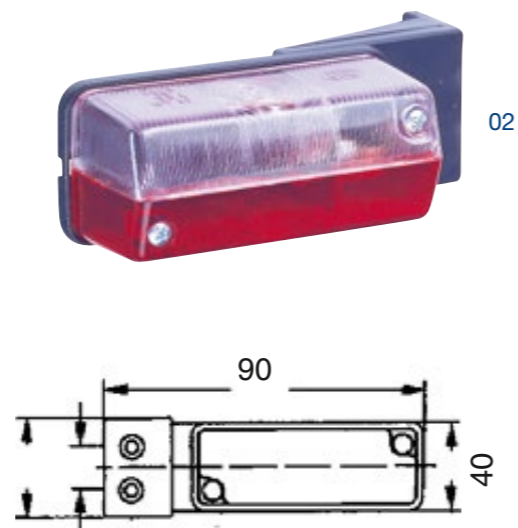

03

outline marker lighting

Block

▶ Item no. 1006-10-1

▶ Product description

- With screws
- M5
- Spacing 70 mm

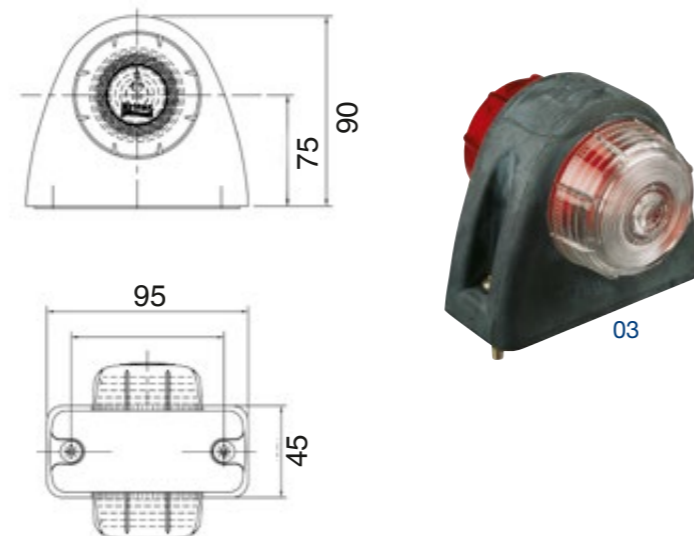

04

LED outline marker lighting

12V/24V

▶ Item no. 1004-90-1

▶ Product description

- With flexible pendular bracket
- Lateral
- Universal application
- Cable length approx. 20 cm

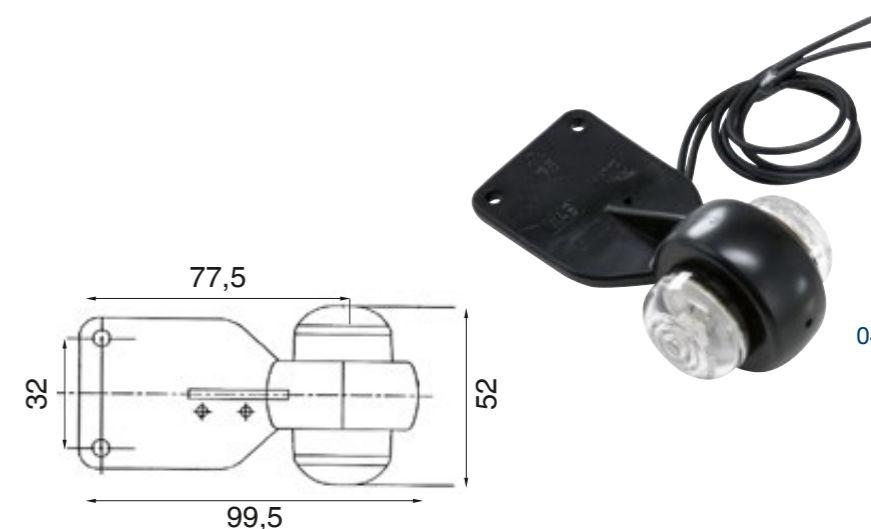

05

LED outline marker lighting set

waterproof, angular

▶ Item no. 1006-13-1

▶ Product description

- Waterproof
- Light emission: red/white/yellow
- Flexible mount housing
- Light lens made of break-proof polycarbonate
- ADR inspected
- 12-24 V / 24V-1W
- Hole spacing of fastening: 78 mm
- Cable length: 1.75 m



06

LED clearance light 12 V - 24 V

▶ Item no. 1004-90-3

▶ left

▶ Item no. 1004-90-4

▶ right



01

LED outline marker lighting

Block

▶ Item no. 1004-50-1

▶ Product description

- 12 V/24 V

- Installation side: left



01

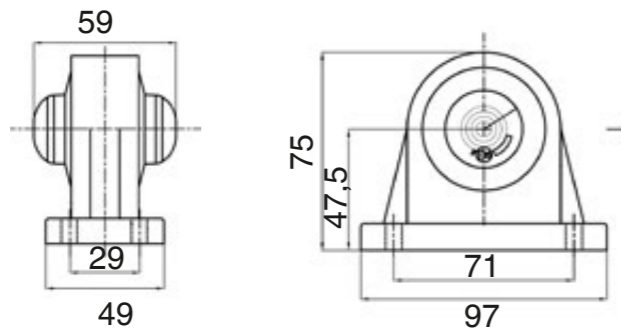

02

LED outline marker lighting

▶ Light emission red/white, with 1.75m ADR cable Item no. 1006-10-31

▶ with pendulum holder

▶ Item no. 1006-10-32

▶ with pendulum holder 90°

▶ Product description

- With flexible mounting case

- Light lens unit made from shatterproof PC

- Spacing 15 mm and 30 mm

- For M6 fastening screws

- GGVS approved



02

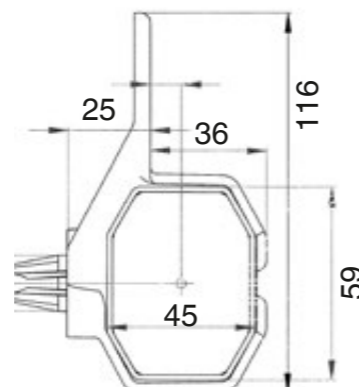

03

LED lights

waterproof

▶ Item no. 1006-12-110

▶ Angled

▶ Item no. 1006-10-3

▶ with mountable casing

▶ Item no. 1006-12-19

▶ LED light unit

▶ Product description

- With flexible mounting casing

- Light lens unit made from shatterproof PC

- For M6 fastening screws

- GGVS/ADR approved



03

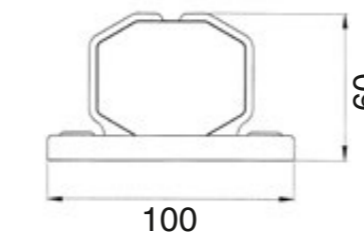
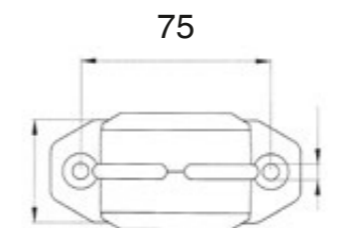
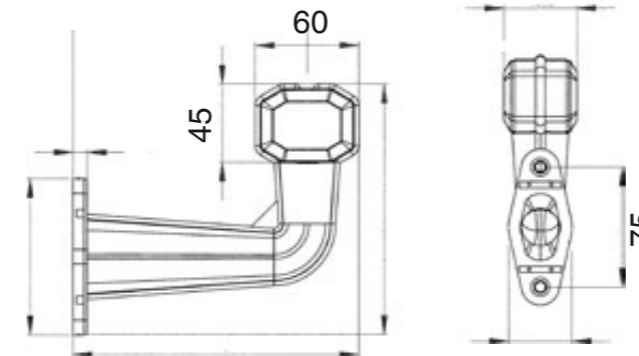

01

LED marker lighting 12 V + 24 V
 angled

Item no.

1004-50-3	left
1004-50-4	right

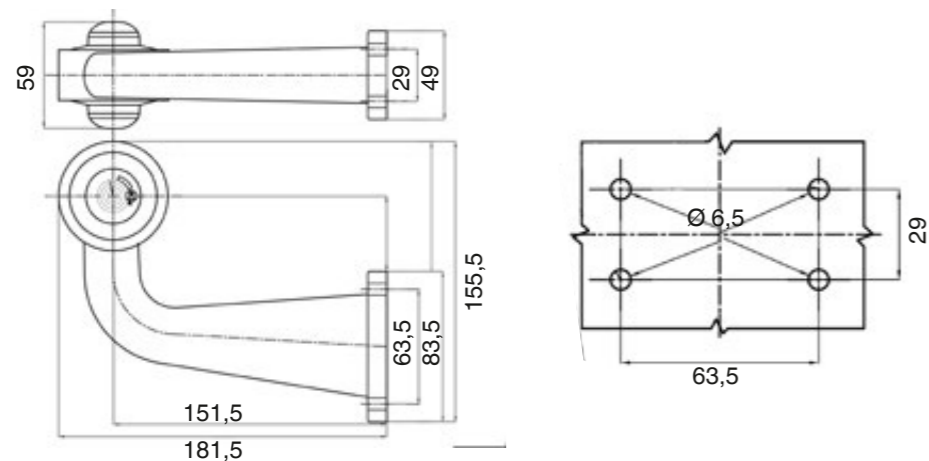

02

LED retrofit kit
 12-24 V

► Item no. 1004-50-5

► Product description

- LED retrofit assembly for article nos.:
- 1004-50-3
- 1004-50-4
- 1006-11-23
- 1006-11-21



03

Marker lighting
 Waterproof, for borehole M6

Item no.

1006-12-100	Marker light with 0.5 m cable
-------------	-------------------------------



04

Marker lighting

Item no.

1006-11-23	angled
1006-11-24	Spare socket
1006-11-253	Light lens red diameter 55 mm
1006-11-254	Light lens transparent diameter 55 mm



05

Side lights
 Angled, waterproof

► Item no. 1006-12-1

► Product description

- Light emission: red/white
- Flexible fixing arm 90°
- Water-tight dual-chamber system in the light lens
- Light lens unit made from break-proof PC
- Incl. 24V/4W bulb (BA9s)
- Cable length 0.5 m
- 12V/24V



01

Flash warning signal lighting unit

With 2 LEDs

▶ Item no. 1001-186-1

▶ Product description

- Operating voltage: 12 V/24 V
- Power: 3 W
- Dimensions: 105 mm x 68 mm
- Connection: Cable 2x 0.75 mm², 0.20 m long, grey
- Installation height: 16 mm
- Two long slots for fastening
- Compatible with almost all LED platform lights



02

Blitz-hazard warning light mini

With 4 LEDs

▶ Item no. 1001-187-1

▶ Product description

- Flashes to the rear and the side
- Completely flat
- Operating voltage: 12 V/24 V
- Power: 4 W
- Dimensions: 85 mm x 85 mm x 110 mm
- Weight: 12 mm
- For securing tail-lifts



04

LED warning signal lighting

Operating mode: Flashing light/Permanent light/Battery test

▶ Item no. 1003-230

▶ Product description

- Power supply: 2 mono-cell batteries 1.5 V (NF art. no. 3722-01)
- Operating voltage: 1.8 V-3.1 V
- Approval: TÜV-tested K452, GGVS tested
- Dimensions: 90 mm x 208 mm x 30 mm
- Weight: 480 g

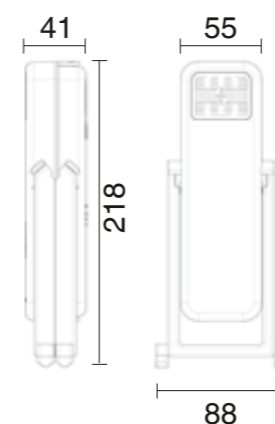

03

Flash warning signal lighting unit

Hula-Blitz

▶ Item no. 1001-184-1

▶ Product description

- Incl. lamp
- Zinc diecast upper part
- Tested to GGVS
- Quality: OEM
- For securing tail-lifts



05

Flash warning signal lighting unit

with 12 LEDs, 24V

▶ Item no. 1001-185-1

▶ Product description

- Life of LED: over 10,000 operating hours
- Diode block: waterproof and dustproof
- Diecast zinc upper section
- 12 cm connection cable
- Tested to GGVS
- For securing platform lifts



01

Side reflector

90 x 40 mm, with adhesive back

- ▶ Item no. 1001-180-41
- ▶ orange/yellow

- ▶ Item no. 1001-180-42
- ▶ red

- ▶ Item no. 1001-180-421
- ▶ white

- ▶ Product description
 - Drill hole spacing 70 mm
 - Drill hole M5
 - Hole diameter [mm] 4.2
 - Height [mm] 40
 - Width [mm] 40
 - Length [mm] 90



02

Side reflector

Ø 60 mm, with adhesive backing, 6 mm drill hole

- ▶ Item no. 1001-180-43
- ▶ orange/yellow

- ▶ Item no. 1001-180-44
- ▶ red

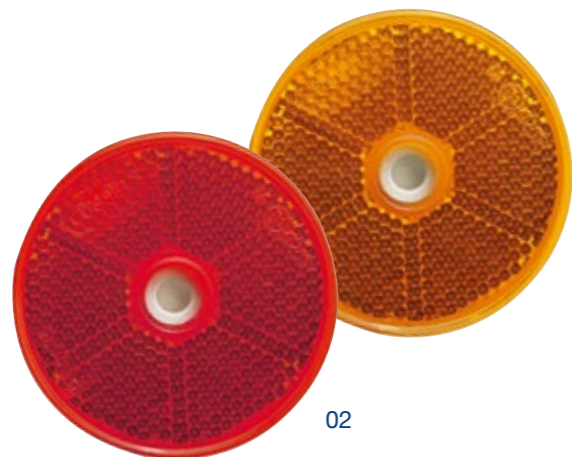

03

Rear reflector

Diameter 90 mm

- ▶ Item no. 1001-180-45

- ▶ Product description
 - With M5 nut and bolt
 - Red



04

Triangular rear reflector

1-piece

- ▶ Item no. 1001-180-50

- ▶ Product description
 - for M6 fastening
 - Hole diameter: 5.2 mm
 - Drill hole spacing: 70 mm
 - Width: 160 mm
 - Length: 139 mm
 - Height: 8.5 mm



05

Triangular rear reflector

4-piece

- ▶ Item no. 1001-180-51

- ▶ Product description
 - 4 individual reflectors
 - Stable plastic housing
 - Incl. 2 fastening screws M 5 x 15 mm
 - Drill hole spacing: 70 mm
 - Length: 155 mm
 - Width: 175 mm
 - Height: 13 mm



01

LED side marker lights
24V/1W

- ▶ Item no. 1001-179-6
- ▶ Lighting unit

- ▶ Item no. 1001-179-69
- ▶ Holder

- With cable
- Depth: 7 mm
- Borehole: M5
- Centre hole: 25 mm

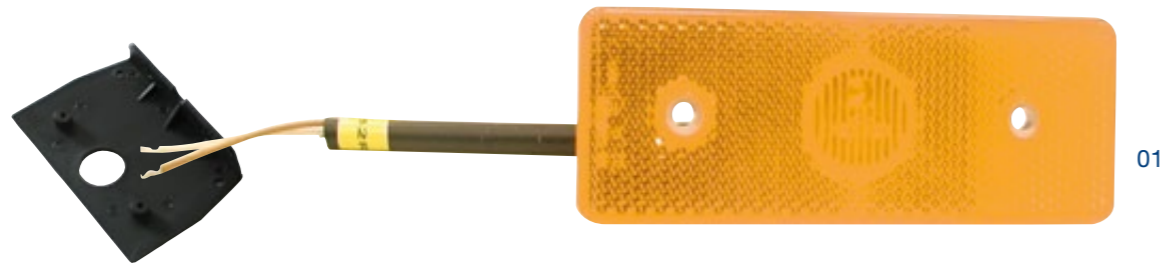
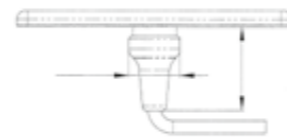
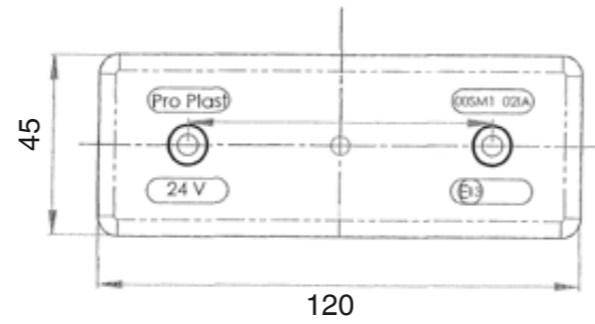

01

02

LED side marker lights
Universal, 12/24 V, with bracket, 12/24 V

- ▶ Item no. 1004-20-1

- ▶ Product description
- Hole spacing: 30 mm

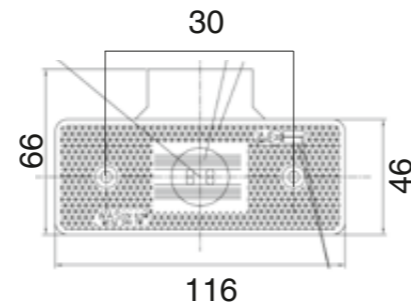

02

03

LED side marker lights
12-24 V, incl. holder and cable

- ▶ Item no. 1004-90-2

- ▶ Product description
- Diode light
- Wires: 22 cm - 0.75 mm²

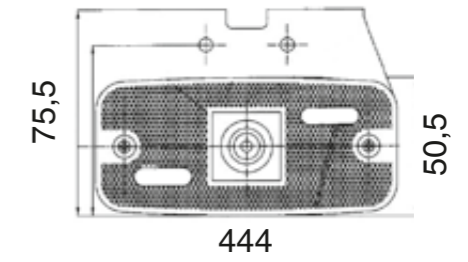

03

04

LED side marker lights
with bracket and cable (MAN), 24 V

- ▶ Item no. 1001-179-7

- ▶ Product description
- With rear reflector
- Repair variant
- Cable length 0.5 m

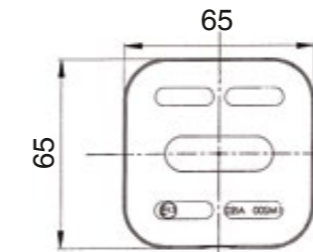

04

05

LED side marker lights
Universal, 12/24 V

- ▶ Item no. 1004-40-1

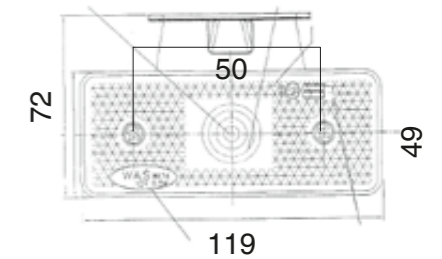

05

01

Warning mark

For containers

▶ Item no. 1001-181-1

▶ Product description

- According to Section 32 (1) no. 27, 49 (4) no. 4
- Film type: type II
- Colour: red/white
- Material: plastic film
- Contents: 4 x pointing left, 4 x pointing right
- 705 mm x 141 mm
- Original 3M
- Type II, DIN 67520, Colour DIN 6171



01

02

Warning mark ECE 70

For tractor units (class 2)

▶ Item no. 1001-181-4

▶ Product description

- Aluminium model
- Film type: type II
- Colour: yellow/orange
- Standard: ECE 70
- 565 mm x 130 mm x 1.0 mm



02

03

Warning marks

For trailers and semitrailers

▶ Item no. 1001-181-2

▶ Item no. 1001-181-3

▶ Product description

- Dimensions: L 570 mm/W 200 mm
- Film type: type II
- Colour: yellow/orange
- E4 007009



03

04

3M contour marking tape

According to the regulations UN/ECE R 104

▶ Item no. 1001-183-04

▶ Red

▶ Item no. 1001-183-05

▶ yellow

▶ Item no. 1001-183-06

▶ white

▶ Product description

- For solid structures
- Adheres to painted, smooth surfaces
- Width: 50 mm, roll length: 50 m



04

05

Edge protection

45.7 m · 25 mm wide

▶ Item no. 1001-183-07

▶ Product description

- Edge-protection film, transparent
- Self-adhesive and simple to use
- For sealing vehicle warning marks, for example
- Protects against dirt, contamination and damage
- Weather-resistant and durable



05

01

Hazard warning flag set

For tail-lifts

► **Product description**

- Dimensions: L 400 mm/W 250 mm
- According to Section 53b Paragraph 5 of the German Road Traffic Act (StVZO), 5
- Building authority approved
- Film type: type II
- Colour: red/white



01

Item no.

1001-182-9	Warning flag set with holder
1001-182-3	Aluminium holder
1001-182-1	Hazard warning flag (pointing left)
1001-182-2	Hazard warning flag (pointing right)

02

Warning mark

141 mm wide

► **Product description**

- According to Section 35 of the German Road Traffic Act (StVO)
- Design: Film
- Film type: Type II
- Colour: red/white
- Material: Plastic
- Attachment: self-adhesive
- 3M quality



02

Item no.

1001-183-02	Pointing right 45.7 m
1001-183-03	Pointing left 45.7 m
1001-183-0	Hazard warning mark set 144 mm x 9 m Contents: 1x9 m pointing left, 1x9 m pointing right

03

ADR warning sign

GGVS/ADR approved, foldable

► **Item no. 1001-181-5**► **Product description**

- Colour: orange
- Film type: Type I
- Dimensions 400 mm x 300 mm
- With edge protection and hole at the top
- Material: Sheet steel



03

04

A warning sign

German waste warning sign

► **Item no. 1001-181-6**► **Product description**

- Colour: White
- Film type: Type I
- Foldable
- With edge protection



04

05

Parking warning sign

foldable, 285 x 285 mm

► **Item no. 1001-180-1**► **Front**► **Item no. 1001-180-3**► **Rear**► **Product description**

- Parking warning sign according to StVZO (Road Traffic Licensing Regulations) § 22a STV20 section 1 number 9
- 8-prism rear reflector
- Film type: Type III
- Colour: red/white
- Material: aluminium

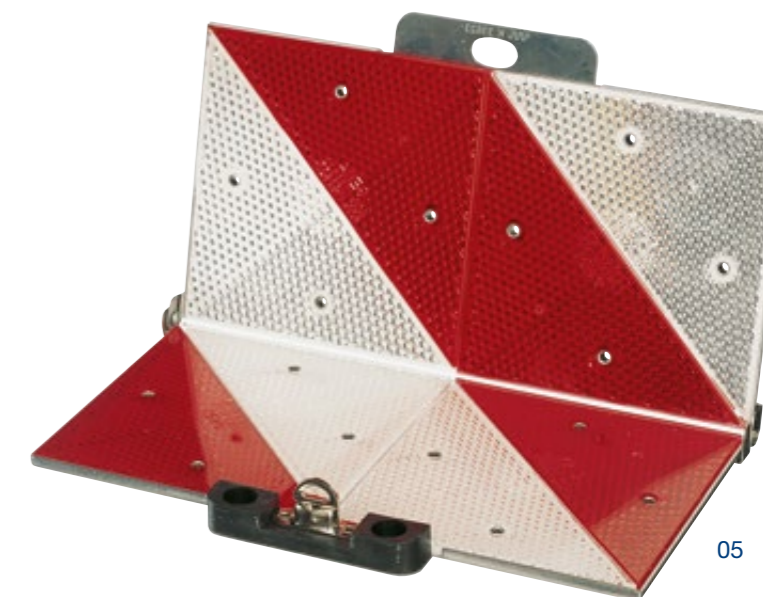

05

01

Plug
15-pole

► Item no. 3555-310-150

- Product description
- With screwed contacts
 - GGVS/ADR tested
 - 15-pole
 - 24 V



02

Plug
7-pole

► Item no. 3555-310-70

- Product description
- With screwed contacts
 - GGVS/ADR tested
 - 7-pole
 - 24 V



05

Plug
3 pole

► Item no. 3555-310-6

- Product description
- With screwed contacts
 - Type S
 - Power rating: 20 A to 24 V
 - Plastic
 - 3-pole
 - 24 V



06

Socket
7-pole

► Item no. 3555-310-7

- Product description
- With screwed contacts
 - GGVS/ADR tested
 - 7-pole
 - 24 V



03

Plug
7-pole

► Item no. 3555-305-589
► Plastic

► Item no. 3555-305-587
► Metal

- Product description
- Power rating: 20 A to 24 V
 - Length: 116 mm
 - Type N / "Light"
 - With screwed contacts



04

Plug
7-pole

► Item no. 3555-305-588
► Plastic

► Item no. 3555-305-586
► Metal

- Product description
- Power rating: 20 A to 24 V
 - Length: 116 mm
 - Type S / "Auxiliary consumer"
 - With screwed contacts



07

Power outlet
7-pole

► Item no. 3555-305-287

- Product description
- With screwed contacts
 - Rubber seal in the cover
 - Type N
 - Load rating: 20 A to 24 V
 - ISO 1185 K-pin
 - 7-pole
 - 24 V



08

Power outlet
7-pole

► Item no. 3555-305-286

- Product description
- With screwed contacts
 - Rubber seal in the cover
 - Type S
 - Load rating: 20 A to 24 V
 - ISO 3731 K-jack
 - 7-pole
 - 24 V



01

Power outlet

3 pole

▶ Item no. 3555-310-60

▶ Product description

- With screwed contacts
- Type S
- Power rating: 20 A to 24 V
- Plastic
- ISO 1185 K
- 7-pole
- 24 V



01

02

Power outlet

15-pole

▶ Item no. 3555-310-15

▶ Product description

- With screwed contacts
- GGVS/ADR tested
- 15-pole
- 24 V



02

03

LED check device

Shunt resistor for vehicles with on-board computer

▶ Item no. 1006-46-34

▶ Product description

- For commercial vehicles with on-board computers and voltage monitoring
- for retrofitting to LED lights
- Nominal voltage: 24V
- Wattage at nominal voltage: 8.4W
- Cable length (2-core): 1 metre
- For replacing max. 3 bulbs (5W) with LED modules
- IMPORTANT! Becomes hot >100°C in continuous use. Select outside installation site!



03

04

Adapter helix cable

15 pole to 2 x 7 pole

▶ Item no. 3555-320-53

▶ Product description

- For the power supply from new truck tractors to older trailers
- 13 pole wired according to standards
- Overmoulded plug type „N“ and type „S“
- Working length: 3.5 m
- Material: PUR
- Recoiling force complies with OEM regulations
- Tightly wound
- 24 V



04

05

Adapter helix cable

15 pole to 2 x 7 pole

▶ Item no. 3555-320-51

▶ Product description

- 13 pole
- Working length: 3,5 m
- Type N/S
- Material: PUR
- Recoiling force complies with OEM regulations
- Tightly wound
- 24 V



05

06

Short adapter

15-pole to 7-pole

▶ Item no. 3555-320-52

▶ Product description

- Adapter from 15-pole to 7-pole
- ISO 12098
- Plastic
- 24 V



06

01

Coil

7-pole

▶ Item no. 3555-320-43

▶ Product description

- Working length: 3.0 m
- Material: PUR
- Recoiling force complies with OEM regulations
- With waterproof plugs
- Type S - 3731
- 6 sockets, 1 pin



01

02

Coil

7-pole

▶ Item no. 3555-320-42

▶ Product description

- Working length: 3.0 m
- Material: PUR
- Recoiling force complies with OEM regulations
- With waterproof plugs
- Type N
- Tightly wound



02

03

EBS helix cable

7-pole

▶ Item no. 3555-320-45

▶ Product description

- Working length: 3.5 m
- Material: PUR
- Recoiling force complies with OEM regulations
- Tightly wound



03

04

Coil

15-pole

▶ Item no. 3555-320-50

▶ Product description

- Working length: 3.5 m
- With clamped connection
- Material: PUR
- Recoiling force complies with OEM regulations
- Tightly wound



04

05

Distribution box

16-fold

▶ Item no. 1004-100

▶ Product description

- GGVS/ADR inspected
- 16-fold



05

01

Battery clamps

Item no.	Model	Max. cable connection	Figure
3510-19	+ on the right	70 mm ²	1
3510-20	- on the left	70 mm ²	2



02

Battery clamps

Item no.	Model	Max. cable connection	Figure
3510-6	- on the right	70 mm ²	1
3510-7	+ on the left	70 mm ²	2



03

Lantern battery

Block 4R25 6 Volt - 7 Ah

► Item no. 3722-60

► Product description

- 4-R25
- 6V
- 7Ah
- For use in construction-site flashing lights



04

Coupling head

Standard, without valve, e.g. for trailers

Item no.	Colour	Model
1005-50-01	yellow	M16
1005-50-02	red	M16
1005-50-03	yellow	M22
1005-50-04	red	M22
1005-52-03		Spare gasket



05

Coupling head

Automatic, with check valve

Item no.	Colour	Model
1005-51-01	yellow	M16
1005-51-02	red	M16
1005-51-03	yellow	M22
1005-51-04	red	M22



06

Handles

Set

► Item no. 1005-10-003

► Product description

- For M16 air coils

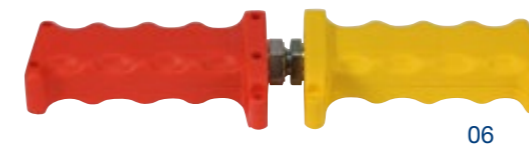

07

Threaded piece

with supply lines

Item no.	Model
1005-41-01	Short, M16
1005-41-02	M22 short
1005-41-03	M16 long
1005-41-04	M18 long



01

PU coil

21 windings, hard-wearing and flexible

- ▶ Item no. 1005-10-001
- ▶ red

- ▶ Item no. 1005-10-002
- ▶ yellow

▶ Product description

- Max. working length: 4.5 m
- With threaded end piece M16
- Temperature range -40°C to +95°C

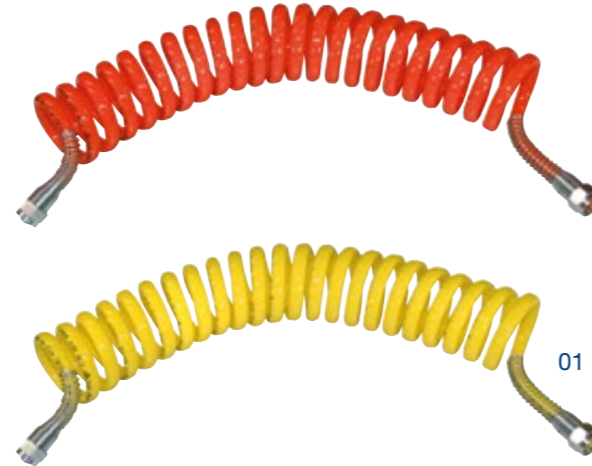

02

NF PU spiral

Hard wearing and flexible

- ▶ Item no. 1005-10-005
- ▶ red

- ▶ Item no. 1005-10-006
- ▶ yellow

- ▶ Item no. 1005-10-007
- ▶ Black

▶ Product description

- 21 windings (tightly wound diameter 80 mm)
- Steel anti-kink spring
- Max. working length 4.5 m
- Temperature range -40°C to +95°C
- Threaded piece M16 on both ends



01
Straight-line connector
Brass

Item no.	Model
1002-16-06	6 mm
1002-16-08	8 mm
1002-16-09	9 mm
1002-16-010	10 mm
1002-16-012	12 mm
1002-16-18	18 mm



01

02
T-connector
Brass

Item no.	Model
1002-14-06	6 mm
1002-14-08	8 mm



02

03
Reducer coupling
Brass

Item no.	Model
1002-8-6	6-8 mm
1002-10-6	6-10 mm
1002-10-8	8-10 mm
1002-12-8	8-12 mm
1002-12-10	10-12 mm



03

04
Straight-line connector
Plastic

Item no.	Model
1002-06-04	4 mm
1002-06-05	5 mm
1002-06-06	6 mm
1002-06-08	8 mm
1002-06-10	10 mm
1002-06-12	12 mm



04

05
Angle connector
Plastic

Item no.	Model
1002-02-06	6 mm
1002-02-08	8 mm



05

06
T-joint
Plastic

Item no.	Model
1002-04-04	4 mm
1002-04-06	6 mm
1002-04-08	8 mm



06



07
Assortment of direct connectors
Brass, plastic

► Item no. 1957-100-1

Contents: 40 parts

- 5 x Plastic straight connector 4mm (art. no. 1002-06-04)
- 5 x Plastic straight connector 5mm (art. no. 1002-06-05)
- 5 x Plastic straight connector 6mm (art. no. 1002-06-06)
- 5 x Plastic straight connector 8mm (art. no. 1002-06-08)
- 5 x Brass straight connector 10mm (art. no. 1002-16-010)
- 5 x Brass straight connector 12mm (art. no. 1002-16-012)
- 5 x Brass straight connector 6mm (art. no. 1002-16-06)
- 5 x Brass straight connector 8mm (art. no. 1002-16-08)



07



01
Cutting pliers for polyamide tubes

- ▶ Item no. 1002-08-100
- ▶ Item no. 1002-08-111
- ▶ Spare blades



02
Brake rings
HGV air brake, brake screw connection

Item no.	Ring model	Sealing ring model
6464-12-16	12 x 16	10 x 14
6464-14-18	14 x 18	12 x 17
6464-16-22	16 x 22	15 x 19
6464-18-22	18 x 22	16 x 20
6464-22-27	22 x 27	20 x 24



03
Pipe support clamps
Rubberised

- ▶ Product description
- Full galvanized steel
- RSGU
- Rubberized



Item no.	Pipe diameter	Band	Hole Ø
5542-6-12	6 mm	12 mm	5,3 mm
5542-6-15	6 mm	15 mm	6,4 mm
5542-8-12	8 mm	12 mm	5,3 mm
5542-8-15	8 mm	15 mm	6,4 mm
5542-8-20	8 mm	20 mm	8,4 mm
5542-9-12	9 mm	12 mm	5,3 mm
5542-10-12	10 mm	12 mm	5,3 mm
5542-10-15	10 mm	15 mm	6,4 mm
5542-12-12	12 mm	12 mm	5,3 mm
5542-12-15	12 mm	15 mm	6,4 mm
5542-15-12	15 mm	12 mm	5,3 mm
5542-15-15	15 mm	15 mm	6,4 mm
5542-15-20	15 mm	20 mm	8,4 mm
5542-18-15	18 mm	15 mm	6,4 mm
5542-20-15	20 mm	15 mm	6,4 mm
5542-20-20	20 mm	20 mm	8,4 mm
5542-25-12	25 mm	12 mm	5,3 mm
5542-25-15	25 mm	15 mm	6,4 mm
5542-25-20	25 mm	20 mm	8,4 mm
5542-30-15	30 mm	15 mm	6,4 mm
5542-30-20	30 mm	20 mm	8,4 mm
5542-35-15	35 mm	15 mm	6,4 mm
5542-40-20	40 mm	20 mm	8,4 mm
5542-50-15	50 mm	15 mm	6,4 mm

04
Polyamide tubes
Pressure-resistant to 15 bar, 25 metre coil, DIN 73378

Item no.	Ø x wall thickness
1002-54-06	6 x 1.0 mm
1002-54-08	8 x 1.0 mm
1002-54-09	9 x 1.5 mm
1002-54-10	10 x 1.0 mm
1002-54-12	12 x 1.5 mm
1002-54-15	15 x 1.5 mm



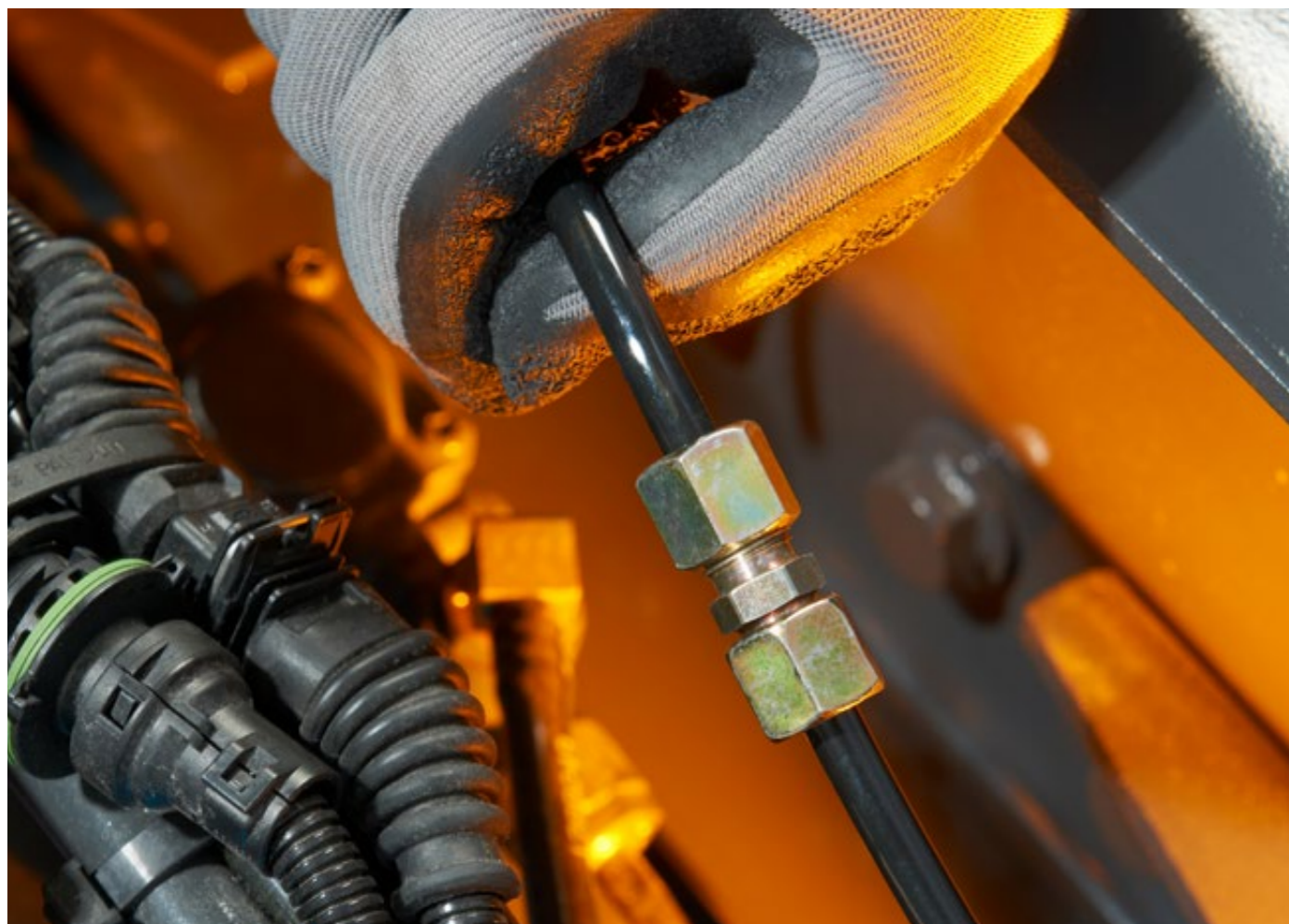

01
Support sleeves

Item no.	Tube
1002-54-061	6 x 1,0
1002-54-081	8 x 1,0
1002-54-101	10 x 1,0
1002-54-121	12 x 1,5
1002-54-151	15 x 1,5



02
Cutting rings

Item no.	Tube
1002-54-062	6 x 1,0
1002-54-082	8 x 1,0
1002-54-102	10 x 1,0
1002-54-122	12 x 1,5
1002-54-152	15 x 1,5



03
Nuts

Item no.	Tube
1002-54-063	6 x 1,0
1002-54-083	8 x 1,0
1002-54-103	10 x 1,0
1002-54-123	12 x 1,5
1002-54-153	15 x 1,5



04
Threaded fittings
incl. 2 cutting rings

Item no.	Tube
1002-54-064	6 x 1,0
1002-54-084	8 x 1,0
1002-54-104	10 x 1,0
1002-54-124	12 x 1,5
1002-54-154	15 x 1,5



05
Lubricator nipple
DIN 71412, H 1

Item no.	Model
6986-40	M6 x 1
6986-41	M8 x 1
6986-42	M10 x 1



06
Lubricator nipple
DIN 71412, H2

Item no.	Model
6986-50	M6 x 1
6986-51	M8 x 1
6986-52	M10 x 1



07
Lubricator nipple
DIN 71412, H 3

Item no.	Model
6986-60	M6 x 1
6986-61	M8 x 1
6986-62	M10 x 1



08
Assortment of screwed connections

► Item no. 1957-54-016

Inhalt: 123 Teile

10 x Cutting ring 6 (art. no. 1002-54-062)
10 x Cutting ring 8 (art. no. 1002-54-082)
8 x Cutting ring 10 (art. no. 1002-54-102)
8 x Cutting ring 12 (art. no. 1002-54-122)
5 x Cutting ring 15 (art. no. 1002-54-152)
10 x Union nut 6 (art. no. 1002-54-063)
10 x Union nut 8 (art. no. 1002-54-083)
8 x Union nut 10 (art. no. 1002-54-103)
8 x Union nut 12 (art. no. 1002-54-123)
5 x Union nut 15 (art. no. 1002-54-153)
10 x Supporting sleeve 6 x 1 (art. no. 1002-54-061)
10 x Supporting sleeve 8 x 1 (art. no. 1002-54-081)
8 x Supporting sleeve 10 x 1 (art. no. 1002-54-101)
8 x Supporting sleeve 12 x 1 (art. no. 1002-54-121)
5 x Supporting sleeve 15 x 1,5 (art. no. 1002-54-151)



01

Lashing strap

▶ Item no. 1002-55-255

▶ Product description

- Colour: orange
- Width: 50 mm
- Length: 8 m (7.5 m belt/0.5 m ratchet) with claw hook
- With low elasticity
- Abrasion-proof and wear resistant
- Galvanised hook and pressure ratchet with manual lever securing
- Two gear wheels
- Highly reinforced polyester fabric
- With "NORMFEST" logo printed on it
- Pre-tensioning force: SHF 50 daN/STF 300 daN
- Tractive force: 2,500 daN
- Tested to EN 12195-2
- Temperature range: -40°C to +100°C
- Made in Germany



01

02

Long-lever tension belt

▶ Item no. 1002-55-258

▶ 8 m (STF 500daN)

▶ Item no. 1002-55-259

▶ 10 m (STF 600 daN)

▶ Product description

- Colour: orange
- Width: 50mm
- Pre-tensioning force: STF 600 daN
- Manual force: SHF 50 daN
- Tractive force (holding force): LC 2,500 daN (5,000 kg)
- Tested to DIN EN 12195-2
- Can be used at temperatures from -40°C to +100°C as standard
- Elongation <=5%
- With optimum label protection



02

03

Anti-slip mat

Regupol 7210 LS

▶ Item no. 1002-56

▶ Product description

- Dimensions: 5 m long x 25 cm wide
- Thickness: 8 mm
- Resistant to: UV rays, sodium chloride, weak acids and alkalis
- Cleaning: shake out, vacuum, wash, possibly using a high-pressure cleaner
- Colour: black with dark green, light green and yellow colour particles
- Reusable

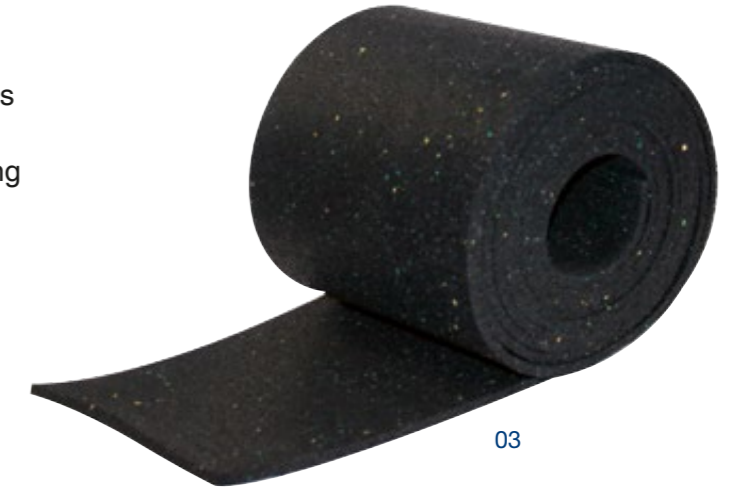

03

04

Edge protection for tension belts

Protection from sharp-edged loads

▶ Item no. 1002-55-2

▶ Product description

- Dimensions: 100 mm x 100 mm
- Can be used for 90° angles
- Slotted, 45° bevel for simple threading of the tension belt
- Protects the belt from sharp, rough edges
- The strap guide and side lugs prevent the edge-protection corners from slipping or falling off
- Better distribution of pre-tensioning forces



04



01

Tarpaulin repair plaster

Extreme adhesion

- ▶ Item no. 1001-190-1
- ▶ Colour: white

- ▶ Item no. 1001-190-2
- ▶ Colour: silver

▶ Product description

- Highly tear-resistant PVC fabric (OEM tarpaulin material)
- Extreme adhesion, self adhesive on one side
- Adhesive: Special adhesive resistant to weather and ageing
- Tear resistance: 2,500 N/5 cm to DIN EN ISO 1421/VI
- Tear-propagation resistance: 270 N (to DIN 53363)
- Weight: 650 g/m
- Thermal stability: -30°C to +70°C
- Best adhesion at temperatures from: +10°C to 25°C
- Weather-resistant and durable
- UV-resistant and resistant to washing brushes



01



01

Pressure roller

For tarpaulin welding

- ▶ Item no. 1010-100-1



01

02

Buckle strap

Width 20 mm

- ▶ Item no. 1010-60-350
- ▶ Length: 350 mm, hole spacing: 22 mm
- ▶ Item no. 1010-60-500
- ▶ Length 500 mm, hole spacing: 22 mm



02

03

Tarp hooks

For rotational lock, reinforced with rounded edges, polyamide 6

Item no.	Model	Hole spacing	Hole Ø
1010-30-01	silver	20 mm	3 mm



03

04

Flat hooks

galvanised

Item no.	Model	Hole spacing	Hole Ø
1010-30-11	20 x 2 mm	20 mm	3 mm



04

05

Three-hole tarp hooks

Plastic, grey

Item no.	Model	Hole Ø
1010-30-21	45 x 40 mm	3 mm



05

06

Rubber plug

Adjustable, 280 mm x 40 mm

- ▶ Item no. 1010-70-500



06

07

Rubber tension ring

Ø 8 mm, black

- ▶ Item no. 1010-70-200
- ▶ Length: 200 mm
- ▶ Item no. 1010-70-250
- ▶ Length: 250 mm
- ▶ Item no. 1010-70-400
- ▶ Length: 400 mm



07

08

S-hooks

galvanised

Item no.	Model
1010-31-030	3.0 x 30 mm
1010-31-042	4.2 x 45 mm



08

09

Strap cramp

For 36 and 40 mm round eyelets and 42 x 22 mm oval eyelets, galvanised

Item no.	Height	Hole spacing	Hole Ø
1010-20-025	25 mm	51 mm	5 mm
1010-20-030	30 mm	51 mm	5 mm
1010-20-038	38 mm	51 mm	5 mm



09

10

Buckle strap

For 38 x 8 mm and 40 x 10 mm slotted eyelets, galvanised

Item no.	Height	Hole spacing	Hole Ø
1010-24-220	20 mm	51 mm	5 mm



10

01

Hollow punch
round

▶ Item no. 1010-91-040

- ▶ Product description
- Hollow punch, round forged version
 - Diameter 40 mm

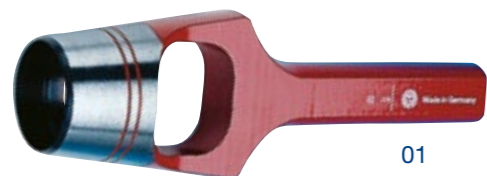

02

Die
round

▶ Item no. 1010-90-040

- ▶ Product description
- Ø 40 mm

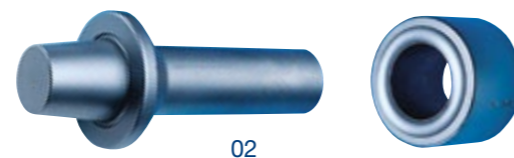

04

Twist clamp
for expander and tarp rope

- ▶ Item no. 1010-032-08
- ▶ 8 mm
- ▶ Item no. 1010-032-10
- ▶ 10 mm



05

Rope end closure
with simplex hook, galvanised

- ▶ Item no. 1010-50-008
- ▶ Ø 8 mm
- ▶ Item no. 1010-50-010
- ▶ Ø 10 mm



03

Round eyelet
Galvanised

▶ Item no. 1010-10-040

- ▶ Product description
- Diameter 40 mm
 - In accordance with DIN 7332



06

Expander rope
100 m roll

- ▶ Item no. 1010-536-100
- ▶ Ø 8 mm
- ▶ Item no. 1010-537-100
- ▶ Ø 10 mm



07

Tarpaulin rope
Ø 8 mm

- ▶ Item no. 1010-532-100
- ▶ Transparent, length: 100 m
- ▶ Item no. 1010-535-100
- ▶ Sisal translucent, length: 100 m



01

Thermal paper rolls
for digital tachographs

► Item no. 1003-1-190

► Product description

- Tested by the German Federal Motor Transport Authority to E1-190
- Sale packaging unit = 3 x 10m rolls
- Width: 57 mm
- Paper weight: 60 g
- Top-coated (front and rear coated for optimum protection)



02

Speed-time chart

1 pack = 100 discs

Item no.	
1003-100-01	Universal, 100km/h
1003-125-01	Universal, 125 km/h
1003-140-01	Universal, 140 km/h
1003-125-05	Universal, 180 km/h
1003-125-02	electrical evaluation, 125 km/h

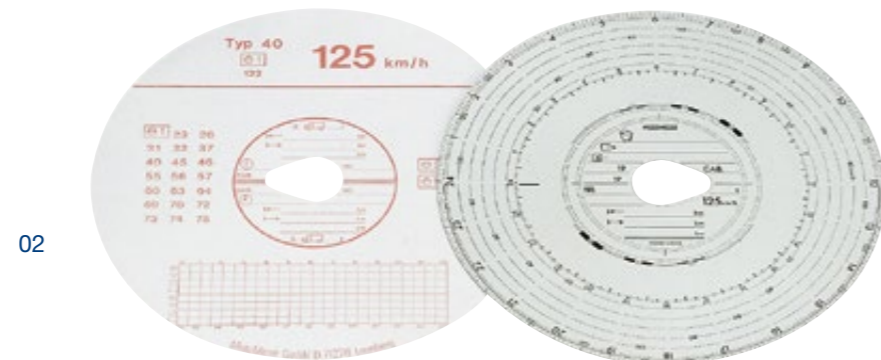

03

Overvoltage protection

► Item no. 4982-500

► Product description

- For commercial vehicles and cars
- Suppresses voltage peaks
- LED connection display
- No unclamping of battery when welding
- No reprogramming of radio, clock, etc.
- Significant time savings



04

Battery charging clips

Item no.	Model
7771-16-200	Red 200 A PCV
7771-16-201	Black 200 A PCV
7771-35-600	Red 600 A CV
7771-35-601	Black 600 A CV



05

Battery jumper cables

Item no.	Ø / mm ²	Length	Figure
7771-16	16	3,0 m	2
7771-35	35 mit Überspannungsschutz	4,5 m	1
7771-50	50	5,0 m	2





01

Tyre Repair Set

Tyron for HGVs

▶ Item no. 9879-971

▶ Product description

- 100% self-vulcanising bands
- Bands passed all TÜV endurance and high-speed test with overload
- Extremely tear-proof and shear resistant in tyres and steel belts thanks to leading-edge technology
- Can be used for straight and 45° punctures
- Suitable for all HGVs

- Set content:

- 25 x 6mm repair body (article no. 9879-974 - refill pack)
- 1 x pilot awl (article no. 9879-976)
- 1 x T-handle (article no. 9879-975)
- 1 x awl (article no. 9879-978)
- 1 x vulcanizing mass 25ml (article no. 9879-980)
- 1 x liquid patch 50ml (article no. 9879-979)
- 1 x scraper
- 1 x Allen key



01

02

Refill pack for Tyron repair kit

Tyron

▶ Item no. 9879-974

▶ Product description

- 100% self-vulcanising bands
- Bands passed all TÜV endurance and high-speed tests with overload
- Extremely tear-proof and shear resistant in tyres and steel belts thanks to leading-edge technology
- Can be used for straight and 45° punctures
- Suitable for all HGV tyres

- Contents:

- 25 x 6 mm repair body
- 1 x liquid patch 50ml



02

03

Tyron

Liquid patch

▶ Item no. 9879-979

▶ Contents: 50 ml

▶ Packing unit: 1



03

04

Awl

▶ Item no. 9879-978



04

05

Vulcanising substance

▶ Item no. 9879-980

▶ Contents: 25 ml

▶ Packing unit: 1



05

06

T-handle

▶ Item no. 9879-975



06

07

Penetrating awls

Length: 11.5 cm

▶ Item no. 9879-976



07



01
Tyrex
Adhesive for tyre probes

- ▶ Item no. 9879-94-250
- ▶ Contents: 237 ml
- ▶ Packing unit: 1

02
Tyre probes
Diam. 10 mm, PU: 10

- ▶ Item no. 9879-92-10

03
Tyre probes
Diam. 4.5 mm, PU: 10

- ▶ Item no. 9879-92-04



04
Miller
Diameter 6mm

- ▶ Item no. 9879-93-06

05
Tread roller
for tyre probes

- ▶ Item no. 9879-91-2

06
Special rubber milling cutter
For roughening the inner surface
of tyres

- ▶ Item no. 9879-91-1



01

Zinc striking weights for FORD steel rims type 187

Zinc striking weights for FORD steel rims type 187

► Technical specifications

- Genuine part for FORD Transit and FORD Transit Custom 05/2014



Item no.	Weight	Item no.	Weight
9836-187-10	10 g	9836-187-40	40 g
9836-187-15	15 g	9836-187-45	45 g
9836-187-20	20 g	9836-187-50	50 g
9836-187-25	25 g	9836-187-55	55 g
9836-187-30	30 g	9836-187-60	60 g
9836-187-35	35 g		

03

Wheel balance weight for 15° tapered rims

Lead, from 22.5" x 6.75" to 26 inches



Item no.	Weight	Item no.	Weight
9836-32-50	50 g	9836-32-250	250 g
9836-32-75	75 g	9836-32-300	300 g
9836-32-100	100 g	9836-32-350	350 g
9836-32-150	150 g	9836-32-400	400 g
9836-32-200	200 g		

02

Zinc striking weights for steel rims type 164

For steel rims type 164

► Technical specifications

- Genuine part for MERCEDES-BENZ Sprinter
- For steel rims on French vehicles
- For steel rims on light commercial vehicles (with greater material thickness)
- FORD Transit up to 2013
- VW Crafter



Item no.	Weight	Item no.	Weight
9836-164-5	5 g	9836-164-35	35 g
9836-164-10	10 g	9836-164-40	40 g
9836-164-15	15 g	9836-164-45	45 g
9836-164-20	20 g	9836-164-50	50 g
9836-164-25	25 g	9836-164-55	55 g
9836-164-30	30 g	9836-164-60	60 g

04

Striking weight for 15° tapered rims

Lead, from 22,5 x 6,75 to 26,50 x 12,00



Item no.	Weight	Item no.	Weight
9836-32-75	75 g	9836-32-250	250 g
9836-32-50	50 g	9836-32-300	300 g
9836-32-100	100 g	9836-32-350	350 g
9836-32-150	150 g	9836-32-400	400 g
9836-32-200	200 g		





01
Commercial vehicle valve
Alligator, CVV

- ▶ Item no. 9879-530-40
- ▶ 40 mm
- ▶ Item no. 9879-530-47
- ▶ 47 mm
- ▶ Item no. 9879-530-60
- ▶ 60 mm



02
Valve
For tubeless commercial vehicle tyres, straight version

- ▶ Item no. 9879-800-41
- ▶ 9.7 x 41 mm



03
Metal valve
For vans, PCVs and vehicles with high tyre pressure

- ▶ Item no. 9879-413-40
- ▶ 40 mm
- ▶ Item no. 9879-414-47
- ▶ 47 mm
- ▶ Product description
 - Pressure-resistant up to 14 bar
 - Wrench size 11
 - High-temperature seal for peak temperatures of over +150°C



04
Tyre valve insert tool
Coated in plastic

- ▶ Item no. 9879-54-041
- ▶ Product description
 - Length: 290 mm



05
Extension cap with seal
Check valve

- ▶ Item no. 9879-66



06
Valve extension
Air-Flexx, steel, flexible

- ▶ Item no. 9879-700-145
- ▶ 145 mm
- ▶ Item no. 9879-700-185
- ▶ 185 mm
- ▶ Item no. 9879-700-215
- ▶ 215 mm



07
Valve extension
Plastic, rigid

- ▶ Item no. 9879-74
- ▶ 115 mm
- ▶ Item no. 9879-75
- ▶ 150 mm
- ▶ Item no. 9879-76
- ▶ 170 mm



H7

- Up to 100% more light on the road
- Up to 100% longer life (LL)



Item no.	Implementation	Base
3720-064-274	24V H7 70W HD LL, Osram Truckstar Pro	Px26d

H1

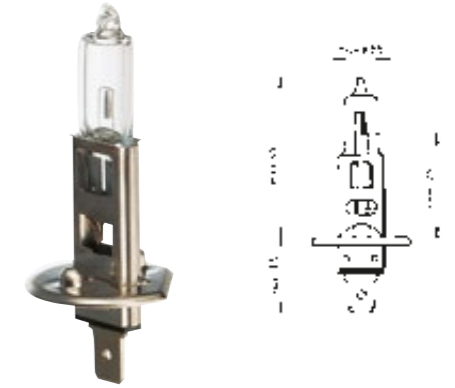

Item no.	Implementation	Base
3720-064-270	24V H1 70W HD LL	P14.5s

Item no.	Implementation	Base
3723-064-155	24V H1 70W	P14.5s

NORM LIGHT

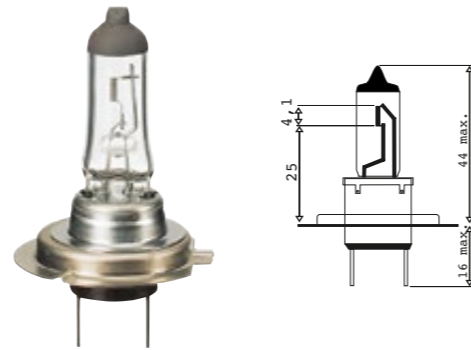

Item no.	Implementation	Base
3720-064-273	24V H7 70W HD LL	Px26d

Item no.	Implementation	Base
3723-064-211	24V H7 70W	Px26d

NORM LIGHT

H3

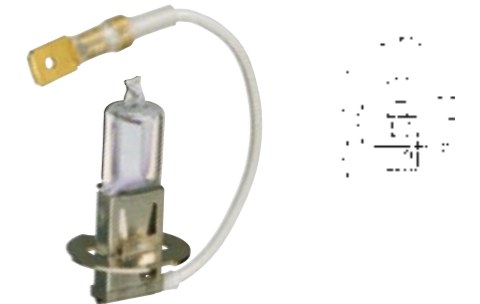

Item no.	Implementation	Base
3720-064-271	24V H3 70W HD LL	PK22s

Item no.	Implementation	Base
3723-064-151	24V H3 70W	PK22s

NORM LIGHT

H4



Item no.	Implementation	Base
3720-064-272	24V H4 70/75W HD LL	P43t

Item no.	Implementation	Base
3723-064-196	24V H4 70/75W	P43t
3723-064-197	24V H4 70/75W HD	P43t

NORM LIGHT

HD = VIBRATION RESISTANT

LL = LONG LIFE

01

Gas discharge headlight bulb D2S
XENON

► Item no. 3720-064-222

- Product description
- For projector headlights
- Approx. 4,100 Kelvin
- Voltage: 12 to 85
- Base: D2S
- Wattage: 35

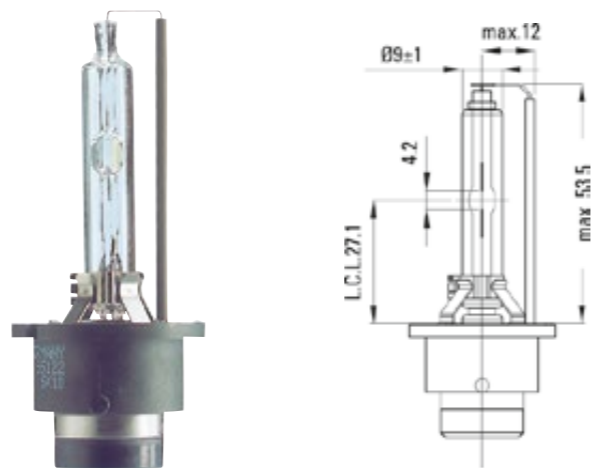

02

Gas discharge headlight bulb D2R
XENON

► Item no. 3720-064-223

- Product description
- For reflector headlights
- Approx. 4,000 Kelvin
- Voltage: 12 to 85
- Base: D2R
- Wattage: 35

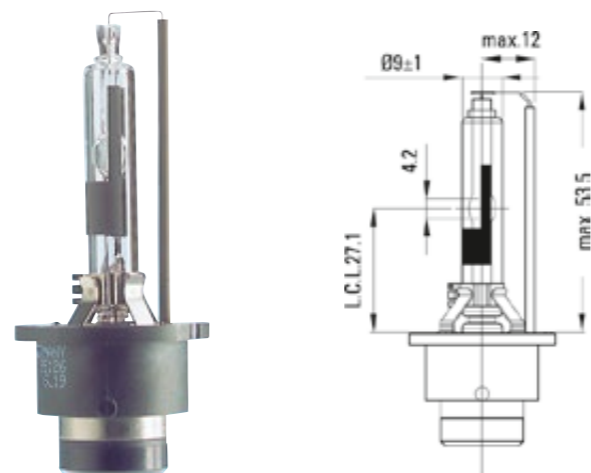

03

Gas discharge headlight bulb D1S
XENON

► Item no. 3720-064-224

- Product description
- Approx. 4,000 Kelvin
- Base: D1S
- Wattage: 35

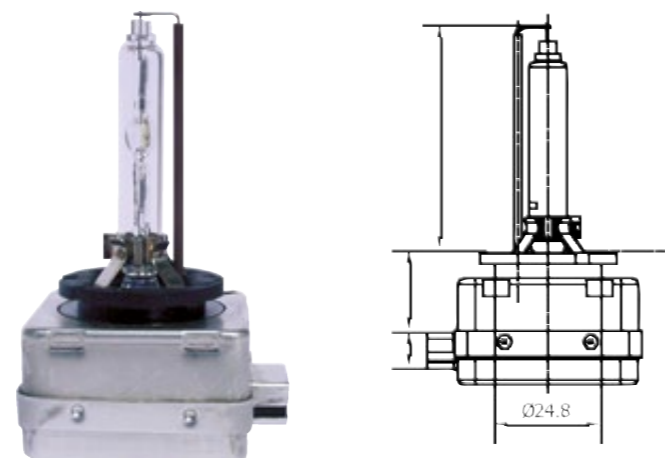

04

Electric discharge lamp

- Product description
- No mercury
- Nominal voltage 42 Volt

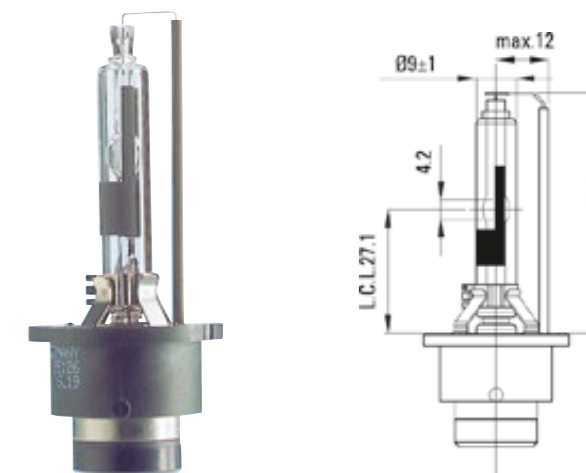

Item no.	Implementation	Base
3720-064-225	D3S 35W 3200 Lumen	PK32d-5
3720-064-226	D4S 35W 3200 Lumen	P32d-5
3720-064-227	D4R 35W 2800 Lumen	P32d-6

BA15s base

- ▶ Item no. 3720-075-35
- ▶ 18W

- ▶ Item no. 3720-075-11
- ▶ 21W

- ▶ Item no. 3720-752-1
- ▶ 21W HD LL

- ▶ Item no. 3723-075-11
- ▶ 21W Normlight

- ▶ Item no. 3723-751-1
- ▶ 21W HD Normlight

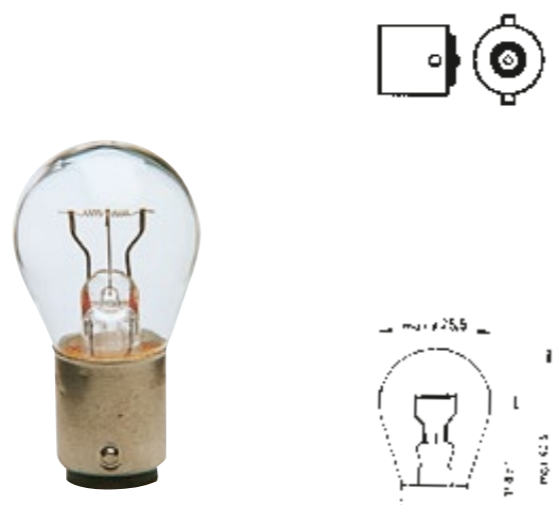

BAY15d base

- ▶ Item no. 3720-075-37
- ▶ 21/5W

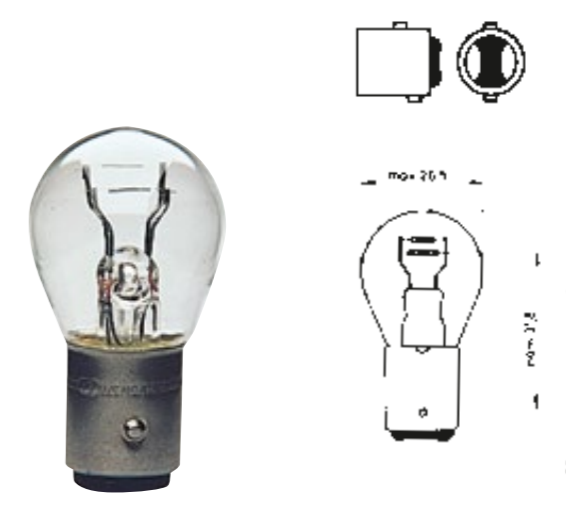

BA15s base

- ▶ Item no. 3720-056-27
- ▶ 5W

- ▶ Item no. 3720-752-3
- ▶ 5W HD LL

- ▶ Item no. 3720-056-37
- ▶ 10W

- ▶ Item no. 3720-752-5
- ▶ 10W HD LL

- ▶ Item no. 3723-562-7
- ▶ 5W HD Normlight

- ▶ Item no. 3723-563-7
- ▶ 10W HD Normlight

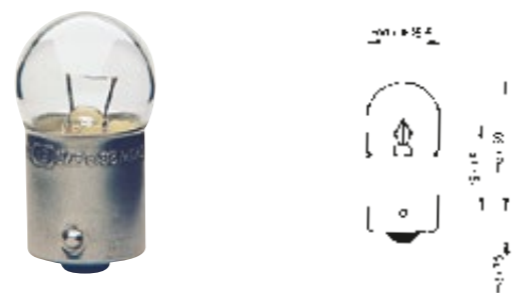

BAZ15D base

- ▶ Item no. 3720-075-47
- ▶ 21/4W



BA15s base

- ▶ Item no. 3720-056-26
- ▶ 5W

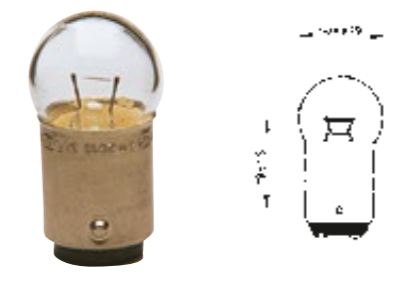

BAU15s base

- ▶ Item no. 3720-752-2
- ▶ 21W HD LL amber (yellow)

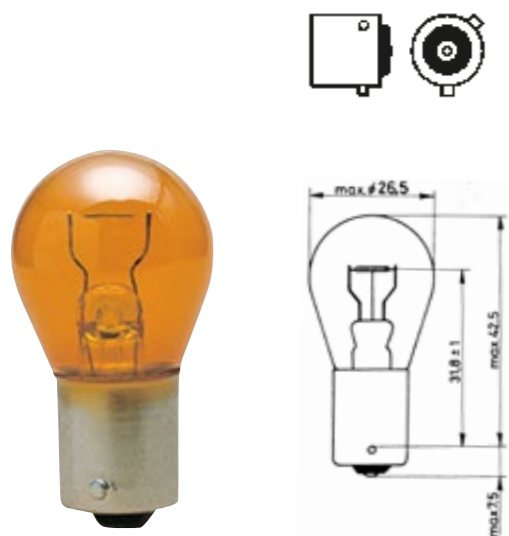

HD = VIBRATION RESISTANT
LL = LONG LIFE



BAY15d base Normlight

- ▶ Item no. 3723-075-37
- ▶ 21/5W



BA7s base

- ▶ Item no. 3720-038-99
- ▶ 3W

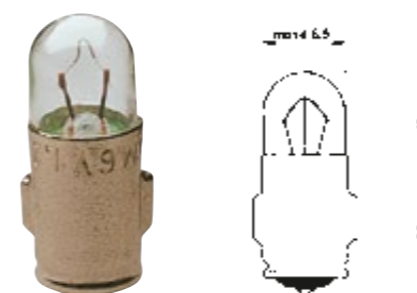

BAY9s base

- ▶ Item no. 3720-075-13
- ▶ 21W Halogen

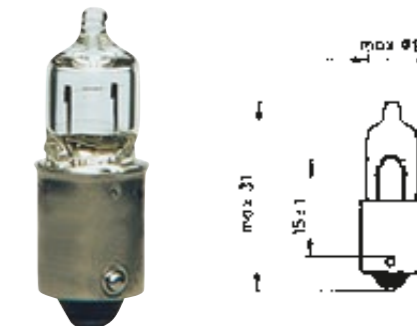

BA9s base

- ▶ Item no. 3720-039-30
- ▶ 4W
- ▶ Item no. 3720-752-6
- ▶ 4W HD LL
- ▶ Item no. 3720-037-97
- ▶ 2W

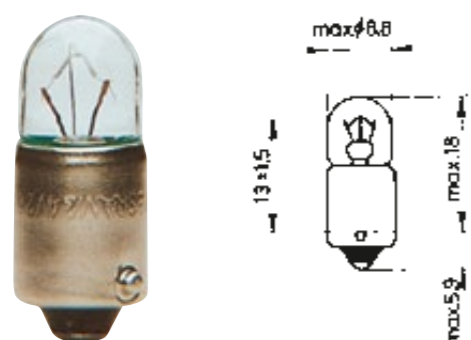

BA9s base

- ▶ Item no. 3723-393-0
- ▶ 4W HD



W2x4.6d base

- ▶ Item no. 3720-027-41
- ▶ 1.2W

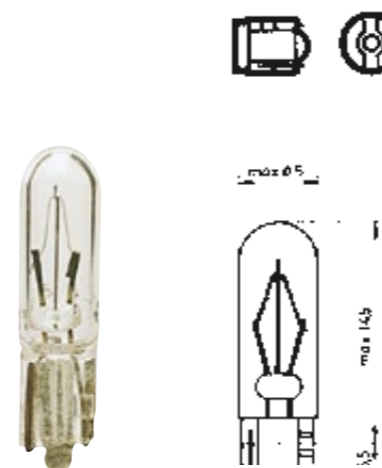

- ▶ W2,1x9:5d base Item no. 3720-028-40
- ▶ 2W
- ▶ Item no. 3720-028-41
- ▶ 3W
- ▶ Item no. 3720-028-45
- ▶ 5W

- ▶ Item no. 3723-028-45
- ▶ 5W Normlight

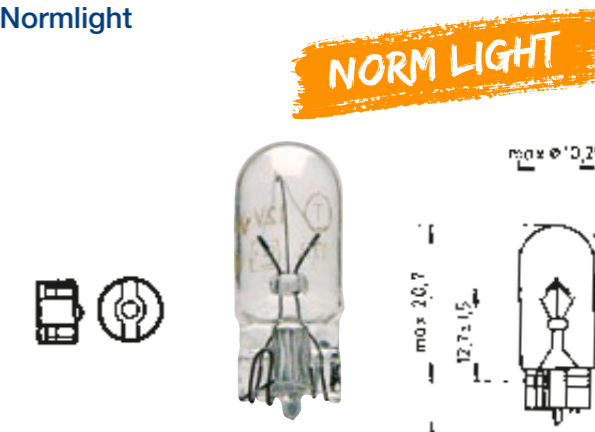

Soffitte 8, 5-8

41 mm

Item no.	Implementation
3720-064-24	5W
3720-064-29	10W

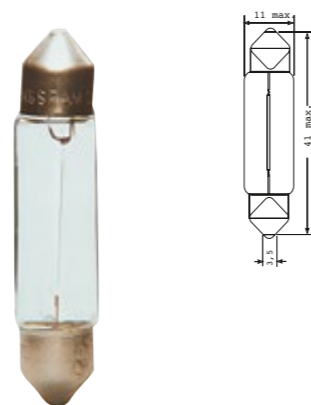

Soffitte 8, 5-8

35 mm

Item no.	Implementation
3720-064-23	5W

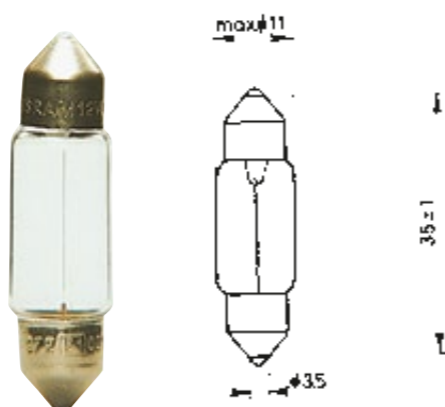

Soffitte 8, 5-8

41 mm

Item no.	Implementation
3720-064-80	18W

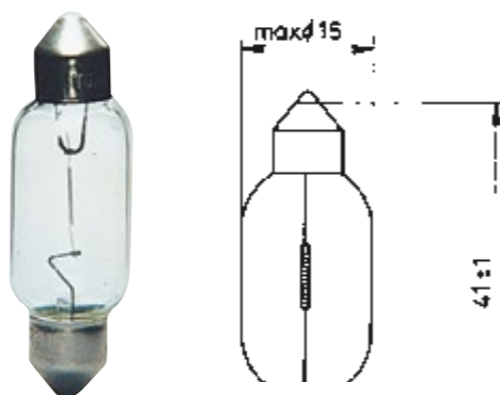

B8,3d

- ▶ Item no. 3720-027-404
- ▶ 1.2W grey

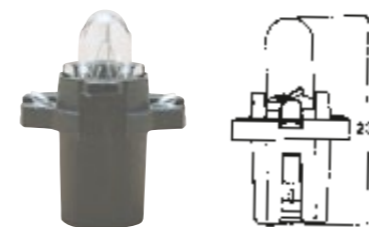

EBS R11

- ▶ Item no. 3720-027-420
- ▶ 1.2 W green suitable for Volvo

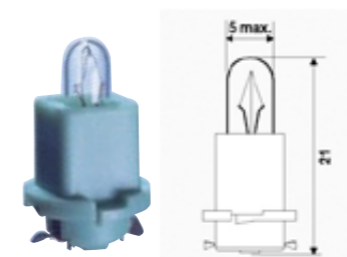

B8,5d

- ▶ Item no. 3720-027-419
- ▶ 1.2W, grey, suitable for tachographs



KW2x4,6D

- ▶ Item no. 3720-027-606
- ▶ 1W white

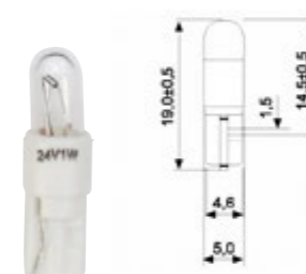

B9

- ▶ Item no. 3720-027-603
- ▶ 2.4W white

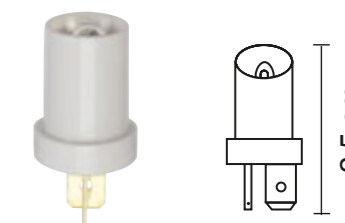

EBS R4

- ▶ Item no. 3720-027-605
- ▶ 1.2W, yellow

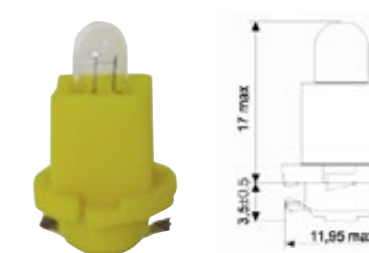

Bx8,5d

- ▶ Item no. 3720-027-600
- ▶ 1.2W, brown

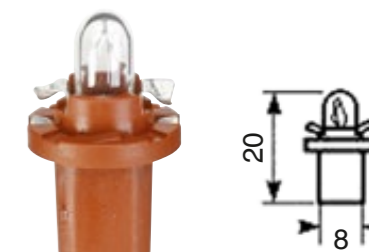



01

Empty bulb box with foam insert for H1 and H7

► Item no. 3720-03-222

► Product description

Replacement bulb box for 24 V and 12 V lights
With liner for H7 and H1 bulbs and additional
places for fuses and tail-light bulbs.



01

02

Box for replacement HGV bulbs 24 V H7/H1

► Item no. 3723-030
► Contents: 22 pieces

► Product description

Contents:

1 x 3723-064-155 Main headlight H1
1 x 3723-064-211 Main headlight H7
2 x 3723-393-0 Parking light 4 W HD
2 x 3723-563-7 Tail light 10 W HD
6 x 3723-075-11 Indicator and brake light 21 W
2 x 3720-064-29 Festoon 8.5-8 10 W
2 x 3731-010 Fuse 10 A
2 x 3731-015 Fuse 15 A
2 x 3731-020 Fuse 20 A
2 x 3731-025 Fuse 25 A



02

03

Glowpoint LED

With shatter-proof casing

► Item no. 3720-075-15

► Product description

- Voltage: 24
- Base: BA15s
- Wattage: 1 W
- Long service life: up to 10,000 operating hours
- Safety: is increased due to high luminance
- Saves energy and costs

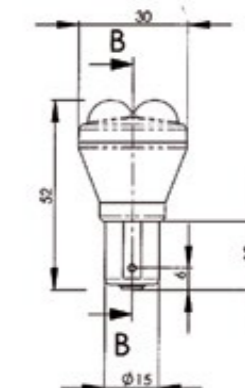

03

Workshop equipment



Tool and gear wagon

► Item no. 7715-909-1



► Item no. 7715-908-1



- Lockable drawers
- Oil-resistant grips
- New locking mechanism for the drawers
- Antistatic coating



- Holder for vacuum lifting pad/windcreens
- Paper-roll holder
- Replaceable rubber edge protection



- Side compartment for aerosol cans
- Two swivel castors
- Smooth-running rubber wheels with brake



01

Tool and gear wagon

Available in blue or black

► **Product description**

- Dimensions: 1,010 mm (h) x 716 mm (w) x 495 mm (d)
- Empty weight: 65.5 kg
- Material: 1.2 mm sheet thickness
- Impact- and scratch-resistant coating
- 5 small drawers and 2 large drawers
- Non-tip

Item no.

7715-908-1	blue
7715-909-1	black



Drawers
Dimensions (interior)

Small drawer:
approx. 563 mm (w) x 393 mm (d) x 60 mm (h)

Large drawer:
approx. 563 mm (w) x 393 mm (d) x 140 mm (h)

Load
Small drawer, max.: 40 kg
Large drawer, max.: 45 kg

Set of combination ring and open-ended spanners

22 pieces, suitable for workshop-wagon drawers

► Item no. 7715-940-1



Screwdriver set

14 pieces, suitable for workshop-wagon drawers

► Item no. 7715-940-4



**A COMPREHENSIVE LIST OF CONTENTS
CAN BE FOUND IN OUR ONLINE SHOP!
SIMPLY PRESS ON THE ARTICLE NUMBER.**

Body pliers set with hammer

8 pieces, suitable for workshop-wagon drawers

► Item no. 7715-940-5



1/4" socket-wrench set

71 pieces, suitable for workshop-wagon drawers

► Item no. 7715-940-7



1/2" socket-wrench set

35 pieces, suitable for workshop-wagon drawers

► Item no. 7715-940-9

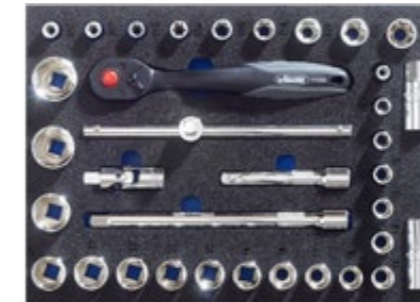

Set of car double-ring spanners

SW6-23mm, 9 pieces, suitable for workshop-wagon drawers

► Item no. 7715-940-2

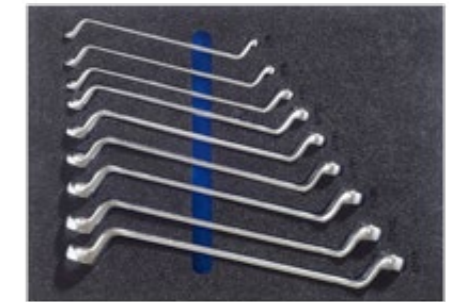

3/8" socket-wrench set

61 pieces, suitable for workshop-wagon drawers

► Item no. 7715-940-8



Torx screwdriver set

11 pieces, suitable for workshop-wagon drawers

► Item no. 7715-940-6



Set of truck double-ring spanners

SW6-32mm, 12 pieces, suitable for workshop-wagon drawers

► Item no. 7715-940-21

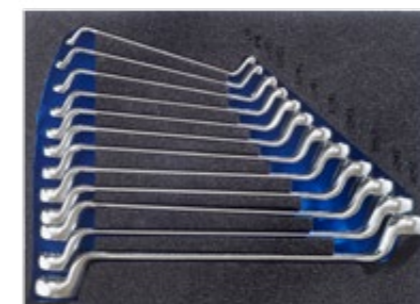

Open-end spanner set

13 pieces, suitable for workshop-wagon drawers

► Item no. 7715-940-3

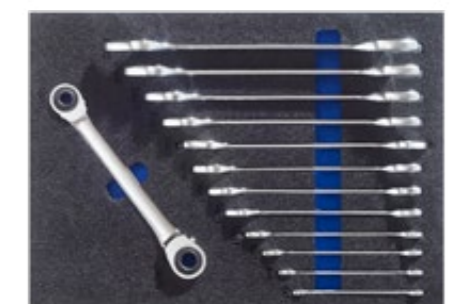

01

Hand protection

Aquano Protect

- ▶ Item no. 2897-500-225
- ▶ Contents: 250 ml
- ▶ Packing unit: 1

- ▶ Item no. 2897-500-2
- ▶ Contents: 2 litres
- ▶ Packing unit: 1

▶ **Product description**

- Protects the skin when dealing with aqueous and non-aqueous materials such as cooling lubricants, dilute acids, alkalis, oils, grease, tar, paints, adhesives, etc.
- Quickly absorbed
- Non-greasy
- pH neutral
- Silicone-free
- Dermatologically tested
- Hypoallergenic

02

Aquano Protect Plus

Excellent skin protection

- ▶ Item no. 2897-500-825
- ▶ Contents: 250 ml
- ▶ Packing unit: 1

- ▶ Item no. 2897-500-8
- ▶ Contents: 2 litres
- ▶ Packing unit: 1

▶ **Product description**

- Dirt-repelling skin protection that can be washed off
- for strongly adhesive, non-aqueous materials, such as oils, paints, bitumen, adhesives, resins, PU foams, etc.
- Made from raw materials with a natural basis
- Free from mineral oils, silicone oils and their derivatives, as well as preservatives

Skin Protection Plan Item no. 2897-500-7

1 HAUTSCHUTZ → vor der Arbeit
Aquano Protect
 Der langanhaltende Hautschutz für alle Anwendungsbereiche.
 - schützt die Haut vor wässrigen und nicht wässrigen Arbeitsstoffen
 - dermatologisch getestet

2 HAUTREINIGUNG → für die Verschmutzung
Aquano Clean
 Die milde und neutrale Reinigungslotion für starke Verschmutzungen.
 - reinigt potentiell
 - ist hautfreundlich mit Rückfettung

Aquano Spezial
 Die Reinigungslotion mit Doppelwirkung für extreme Verschmutzungen.
 - sehr gute Hautverträglichkeit
 - dermatologisch getestet

3 HAUTPFLEGE → nach der Arbeit
Aquano Lotion
 Die wirkstofffreie Hautpflege mit natürlichen Vitaminen.
 - revitalisiert die Haut
 - wirkt gegen trockene, rissige und leicht entzündliche Haut

03

Skin Care

Aquano Lotion

- ▶ Item no. 2897-500-325
- ▶ Contents: 250 ml
- ▶ Packing unit: 1

- ▶ Item no. 2897-500-3
- ▶ Contents: 2 litres
- ▶ Packing unit: 1

▶ **Product description**

- Promotes the regeneration of affected areas of skin
- Suitable for the entire body
- With natural oils and vitamin E
- Non-replenishing
- pH neutral
- Slightly perfumed
- Silicone-free
- Dermatologically tested



01

Hand Cleaner

Aquano Clean

- ▶ Item no. 2897-500-125
- ▶ Contents: 250 ml
- ▶ Packing unit: 1

- ▶ Item no. 2897-500-1
- ▶ Contents: 2 litres
- ▶ Packing unit: 1

▶ **Product description**

- Deep cleansing and long-lasting skin protection
- Hand cleaner easily removes tar, oil, dirt, bitumen and much more
- Aquano is sufficiently replenishing
- Does not block drains
- Silicone-free and dermatologically tested
- Hypoallergenic

02

Special hand cleaner

Aquano Spezial

- ▶ Item no. 2897-500-4
- ▶ Contents: 250 ml
- ▶ Packing unit: 1

- ▶ Item no. 2897-500-42
- ▶ Contents: 2 litres
- ▶ Packing unit: 1

▶ **Product description**

- Intensive, skin-friendly special hand cleaner for very heavy soiling, e.g. paint, acrylic paint, varnish, etc.
- Deep-down cleansing
- Slightly moisturising
- Does not block drains
- Free from preservatives and fragrances
- Silicone free
- Dermatologically tested
-
- Aquano Spezial must not come into contact with plastic surfaces as these may be damaged.

03

Dispenser

Intended for use with 2 litre system bottles

- ▶ Item no. 2897-500-6

▶ **Product description**

- Comes with a pre-installed pump for dispensing hand protection products
- Made from plastic

- Scope of delivery:
 - 1 x system dispenser
 - 4 x 6 mm dowel, stainless-steel screws and washers
 - 1 x key
 - 1 x rotating head
 - 1 x dosing piece
 - 1 x set of installation and operating instructions



03



01

02

04

Hand cleaning Paste

Removes dirt, such as oil, grease, etc.

- ▶ Item no. 2897-240-8
- ▶ Contents: 10 kg jumbo pail
- ▶ Packing unit: 1

▶ **Product description**

- Dermatologically tested
- Silicone free
- Alkali free
- Wood flour based



04

01
Care Protect
The invisible glove

- ▶ Item no. 2897-240-1
- ▶ Contents: 1 litre of lotion
- ▶ Packing unit: 1

- ▶ **Product description**
- Lies on the skin like an invisible protective glove
- Protects the skin when dealing with various materials such as cooling lubricants, dilute acids, alkalis, oils, grease, tar, bitumen and much more
- Silicone-free
- pH skin neutral
- Dermatologically tested
- Non-greasy

02
Care Soft
Hand-Cleaning Lotion

- ▶ Item no. 2897-240-3
- ▶ Contents: 1 litre
- ▶ Packing unit: 1

- ▶ **Product description**
- Particularly skin-friendly cleansing that seriously replenishes the skin thanks to high-quality ingredients
- Particularly suitable for sensitive skin and frequent washing
- pH skin neutral
- Dermatologically tested

03
Care Lotion
Skin Care

- ▶ Item no. 2897-240-2
- ▶ Contents: 1 litre
- ▶ Packing unit: 1

- ▶ **Product description**
- Slightly moisturising skin care lotion, easy to apply and absorbed quickly
- Promotes the regeneration of stressed and dry skin
- Silicone free
- pH neutral
- Dermatologically tested

04
Care Clean
Hand cleaner

- ▶ Item no. 2897-240
- ▶ Contents: 3 litre bucket
- ▶ Packing unit: 1

- ▶ **Item no. 2897-240-010**
- ▶ Contents: 1 litre
- ▶ Packing unit: 10
- ▶ **Product description**
- Removes oil, grease, tar, printing ink, bitumen, etc.
- Deep-down cleansing
- Long-lasting protective effect
- Moisturising
- pH neutral
- Dermatologically tested



05
Nail brush
Bristle type: hard

- ▶ Item no. 2897-500-9

- ▶ **Product description**
- Bristle length: 17 mm
- Colour: black
- Dimensions (H x L x W): 38 mm x 48 mm x 118 mm
- Max. cleaning temperature: +121° C
- Product meets EU Regulation no. 10/2011 regarding food contact: YES

01
Care Dispenser
For 1-litre bottle

► Item no. 2897-240-6

- Product description
- Dispenser for Care 1 litre bottles
 - Fits articles 2897-240-3, 2897-240-1 and 2897-240-2



02
Care Dispenser
For 3-litre pail of Care Clean

► Item no. 2897-240-7

- Product description
- Dispenser for Care Clean 3 litre tub
 - Fits article 2897-240



03
Care Dispenser
for Care Soft

► Item no. 2897-240-4

- Product description
- One dispenser unit for Care Soft 1 litre bottle (2897-240-3)



04
Care wall mount
for 1 litre bottles

► Item no. 2897-240-5

- Product description
- Wall holder for Care 1 litre bottles
 - Suitable for articles 2897-240-1, 2897-240-3 and 2897-240-2



05
Care wall mount & dispenser
for 3 litre tub of Care Clean

► Item no. 2897-240-10

- Product description
- Wall holder with integrated dispenser for Care Clean 3 litre tub
 - Suitable for article 2897-240.



06
Care wall-mounted combi cage
for the complete system

► Item no. 2897-240-15

- Product description
- Combined wall holder for Care Protect 1 litre bottle, Care Lotion 1 litre bottle and Care Clean 3 litre tub

01

Special „Flex-Pro“ gloves

Special black coating on palm and fingertips

► Product description

- Grey stretch fabric
- Elasticised wrist
- Anti-slip
- EN 420, EN 388 CAT 2 silicone free

Item no.	Model
7797-017-8	Size 8
7797-017-9	Size 9
7797-017-10	Size 10
7797-017-11	Size 11



01



02

Special „Flex-Pro“ Plus gloves

Seamless knitted gloves with special stretchy grey fabric

► Product description

- Bobbles on the palm
- Excellent fit
- EN420, EN388 CAT2

Item no.	Model
7797-021-8	Size 8
7797-021-9	Size 9
7797-021-10	Size 10
7797-021-11	Size 11



02

04

Passenger compartment assembly gloves „Fine Knit“

Nylon/cotton, with blue PVC bobbles

► Product description

- Good grip thanks to rubber bobbles
- Manufactured to EN 388 CAT 2
- Circular knitted
- Secure grip
- Washable

Item no.	Model
7797-003-7	Size 7
7797-003-8	Size 8
7797-003-9	Size 9
7797-003-10	Size 10



04

03

„Mechanic’s“ protective gloves

Nylon gloves, partially latex coated

► Product description

- Manufactured to EN 388 CAT 2
- Outstanding grip security in wet and dry working environments

Item no.	Model
7797-004-7	Size 7
7797-004-8	Size 8
7797-004-9	Size 9
7797-004-10	Size 10



03

05

Safety gloves „TOP“

PU coated on the palms and fingertips

► Product description

- Nylon gloves
- Seamless
- Great flexibility and touch
- Non-slip and non-abrasive
- Very good fit

Item no.	Model
7797-001-7	Size 7
7797-001-8	Size 8
7797-001-9	Size 9
7797-001-10	Size 10



05



01

„Cut-Pro“ protective gloves

Black PU coating on palm and fingertips

► Product description

- Greatest cut protection, level: 5
- Special fibre knitted gloves
- Colour: grey
- Silicone-free
- EN 388, EN 407, CAT 2

Item no.	Model
7797-022-8	Size 8
7797-022-9	Size 9
7797-022-10	Size 10
7797-022-11	Size 11



02

02

Work gloves „Cut“

PU coated, Cut protection level 3

► Product description

- cut resistant and mechanically resilient
- manufactured according to EN 388

Item no.	Model
7797-005-8	Size 8
7797-005-9	Size 9
7797-005-10	Size 10



01

03

Anti-Shock glove

Outer material: synthetic leather and elastane

► Technical specifications

- Perfect fit and secure grip
- Good wear and touch properties
- Maximum protection
- For high-vibration and impact work with hammer drills, pneumatic and drilling equipment, heavy tools, etc.
- Padded flexible yellow elastane back
- 3 mm shock-absorbing gel inlays with Clarino® synthetic leather, reinforced fingertips with extra-large anti-slip pads made from silicone
- Knuckle protection
- Palm area made from breathable Clarino® synthetic leather
- Standards: EN 388 CAT II

Item no.	Model
7797-030-9	Size M
7797-030-10	Size L
7797-030-11	Size XL



03

04

Elastic adhesive bandage

Flexi-Tape

► Item no. 7695-50-45

► Product description

- Dimensions: Length 4.50 m, width 50 mm
- Adhesive bandage
- Ideal for injuries to hands and fingers
- Resistant to water and other liquids
- Elastic and tearable



04

01

„Elektro“ protective gloves

For hybrid vehicles

► Product description

- Insulated gloves made from natural red latex
- Category AZC
- Protection against voltages of up to 1,000 Volts
- Class 0

Item no.	Model
7797-020-9	Size 9
7797-020-10	Size 10



01

02

„Chemical“ butyl protective gloves

made from 100% butyl rubber, good grip

► Product description

- Highly impermeable against steam, gases and toxic chemicals
- Highly resistant to dipolar compounds such as esters, ketones, aldehydes, amines, saturated salt solutions and acids and alkalis
- EN 374 and EN 388

Item no.	Model
7797-028-10	Size 10



02

03

Cleaning glove „Chemicals“

Nitrile coated, length: 32 cm

► Product description

- manufactured to EN 388
- CAT 2 & EN 374 CAT 3
- Universal, light protection from chemicals and liquids, e.g. from numerous alkalis, acids, oils, etc.
- Secure grip thanks to diamond pattern
- Anti-bacterial
- Silicone-free

Item no.	Model
7797-009-8	Size 8
7797-009-9	Size 9
7797-009-10	Size 10



03

04

„Chemical“ PVC protective gloves

fully coated

► Product description

- Universal, light protection against chemicals and liquids, such as against numerous alkalis, acids, oils, etc.
- 100% impermeable to liquid
- Secure grip thanks to diamond pattern
- Anti-bacterial
- Silicone-free
- Length: 32 cm

Item no.	Model
7797-010-10	Size 10



04

05

Nitrile coated work gloves blue

Partly coated, ergonomic fit

► Product description

- Very good resistance to oils and grease
- Can be universally used; robust
- Outstanding abrasion resistance
- EN 388 Performance value 2121

Item no.	Model
7797-006-8	Size 8
7797-006-9	Size 9



05

06

Nitrile coated work gloves yellow

Partially coated, GS-tested

► Product description

- Manufactured to EN 420 CAT 2 + EN388
- Good dry grip
- Cotton jersey with knitted cuff

Item no.	Model
7797-007-7	Size 7
7797-007-8	Size 8
7797-007-9	Size 9
7797-007-10	Size 10



06



01
Disposable gloves "Nitrile"
100 per box

- Product description
- Nitrile
 - Powder-free
 - Manufactured according to EN 455

Item no.	Model
7797-016-7	Size S
7797-016-8	Size M
7797-016-9	Size L
7797-016-10	Size XL



01

02
Disposable gloves „Vinyl“
100 pieces per box

- Product description
- Vinyl
 - Powder-free
 - Manufactured according to EN 455

Item no.	Model
7797-026-8	Size M



02

03
Disposable gloves "Latex"
100 per box

- Product description
- Latex
 - Powder-free
 - Manufactured according to EN 455

Item no.	Model
7797-015-8	Size M
7797-015-9	Size L
7797-015-10	Size XL



03

04
Disposable gloves Nitril black
100 pieces per box, silicone-free

- Product description
- No powder or latex
 - Material thickness: 0.08mm
 - Protects against chemicals, very light acids and alkalis

Item no.	Model
7797-029-8	Size M
7797-029-9	Size L
7797-029-10	Size XL



04

05
Disposable „nitrile“ high-risk gloves
50 pieces per box, silicone-free

- Product description
- Colour: blue
 - Non-powdered
 - Twice as thick as standard nitrile disposable gloves
 - Protects against chemicals
 - Food safe
 - Latex free
 - Silicone free

Item no.	Model
7797-031-12	Size XXXL
7797-031-11	Size XXL
7797-031-10	Size XL
7797-031-9	Size L
7797-031-8	Size M



05



01

Latex work gloves „Winter“

Palm PVC coated, lined

► Product description

- Palm PVC coated
- Fingertips with latex coating
- With winter lining
- Level 2 cut resistance
- Neon orange
- Water repellent, water tight for up to 30 minutes
- Performance value 3221
- DIN EN 511

Item no.	Model
7797-025-11	Size 11



01

02

Latex work gloves „Winter“

Latex dipped palm and fingertips, lined

► Product description

- Water repellent and insulating
- Manufactured according to EN 388 & EN 511
- Textured for better grip

Item no.	Model
7797-011-8	Size 8
7797-011-9	Size 9
7797-011-10	Size 10
7797-011-11	Size 11



02

03

„Nappa“ mechanics gloves

Made from a selection of TOP nappa leather

► Product description

- Very supple and robust
- Breathable textile back
- Unlined for best-possible fingertip sensation
- Hook & loop closure at wrist
- EN 420, EN 388 CAT 2

Item no.	Model
7797-023-8	Size 8
7797-023-9	Size 9
7797-023-10	Size 10
7797-023-11	Size 11



03

01

Work gloves „Split Cowhide Leather“

Leather thickness: 1.0 mm

► Product description

- Manufactured to EN 388 CAT 2
- Double seams
- Lines palm
- White back and sailcloth gauntlet

Item no.	Model
7797-014-10	Size 10



02

Work gloves „100% Cowhide“

soft leather

► Product description

- Knuckle protection
- Reinforced palm
- TÜV/GS-tested
- Manufactured according to EN 420 & EN 388 CAT 2

Item no.	Model
7797-013-10	Size 10



03

Protective welding gloves

A combination of leather and split leather

► Product description

- 5-finger welding gloves
- Cowhide/Split leather
- Split cuff
- Length: 35 cm
- TÜV Rhineland tested

Item no.	Model
7797-012-10	Size 10



04

Imitation-leather gloves

Work gloves

► Product description

- with white back and white cuff
- with internal lining
- Moisture-repellent
- Manufactured according to EN 388 / Category II
- Performance value 2111

Item no.	Model
7797-027-10	Size 10



Reinigungshandschuh "CHEMIE"
Art-Nr.: 7797-009-...

- 100% flüssigkeitsdicht
- Schutz gegen eine Vielzahl von Laugen, Säuren, Fette und Öle
- sicherer Griff durch Rautenprofil
- velourisierte Innenfutter
- antibakteriell

Schutzhandschuh "CUT PRO"
Art-Nr.: 7797-022-...

Schutzhandschuh "CUT"
Art-Nr.: 7797-005-...





01

Pro-Vision safety glasses

with compound glass

► Item no. 4695-006-500

► Product description

- The stylish, shatterproof glasses protect the eyes when working.



01

02

Safety glasses Astrospec

Polycarbonate lens

► Item no. 7794-002-0

- Item no. 7794-002-01
- Spare lenses

► Product description

- Anti-mist on the inside
- Scratch-resistant on the outside
- Soft components on the arms for extra wear comfort
- Excellent fit thanks to adjustable arm length
- Easy-to-change lenses
- Highest UV protection (100%)



02

03

Safety glasses X-one

Anti-scratch coating

► Item no. 7794-001-0

► Product description

- Scratch-resistant coating
- Lightweight glasses (28g)
- Stylish design
- Highest UV protection (100%)
- Comfort fit in spite of simple arms



03

04

Nylon goggles

with compound glass

► Item no. 4695-006-433



04

05

Panorama full vision goggles

PC transparent lens, 100% UV protection

► Item no. 7794-003-0

- Item no. 7794-003-01
- Spare lenses

► Product description

- Ergonomically designed full view goggles
- Anti-scratch coating on the outside
- Anti-mist coating on the inside
- Body: grey transparent
- Headband: Uvex, 25 mm
- Highest UV protection (100%)
- Unlimited side vision



05

01

PRO automatic helmet

Carbon look

► Item no. 4695-007-100

► Product description

- Anti-glare dark slide: 1/1/1/2
- Scale numbers DIN 4/5-8 and 9-13
- WIG-suitable from 5 amperes
- Grinding mode
- Large viewing field 53 x 100mm
- Four mutually independent sensors
- Smoothly adjustable
- Power supply using solar cell & replaceable support battery
- Standard attached pane 90 x 110mm
- Interchangeable replacement attached pane, art. no. 4695-007-110

02

Viewing pane 90 x 110 mm

for (4695-007-100)

► Item no. 4695-007-110



02

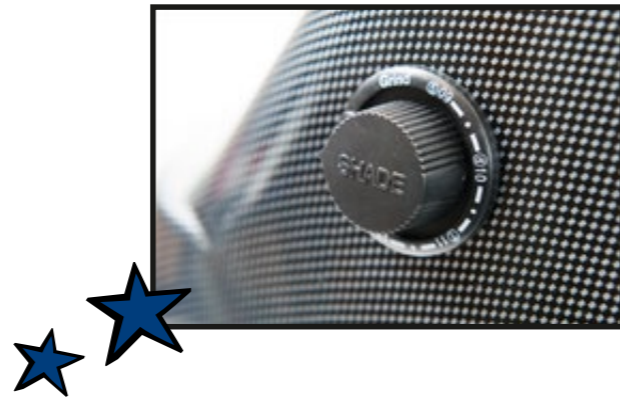

01

03

Hand shield

► Product description

- Partly heat-resistant hand shield without attached pane
- The clear and green attached panes are interchangeable

Item no.	Model
4695-006-440	Shield (without glass)
4695-006-442	Cover lenses clear
4695-006-446	Green lens



03

04

Folding welder goggles

► Product description

- These goggles complete with flip-up front provide a clear view when welding.

Item no.	Model
4695-006-460	Goggles
4695-006-461	Spare lenses non shattering
4695-006-465	Spare lenses athermal



04

05

Ear protection

► Item no. 7126-003-000

► Product description

- Extremely light and comfortable to wear
- Special plastic headband
- Very soft ear cups
- Gentle contact pressure
- SNR value 25 dB



05

06

Clip ear protection

► Item no. 7695-006-610

► Clip ear protection

► Item no. 7695-006-611

► Spare plugs

► Product description

- The handy headband ear defenders are ideal for rapid use in most noise situations
- The oval pads provide an improved fit on the auditory canal



06

07

Shield

► Product description

- Polypropylene headband
- Extremely high impact protection and chemical resistance

Item no.	Model
7936-000-000	Glass
7907-002-000	Head harness



07

08

Ear plugs

► Item no. 7695-006-600

► Product description

- No strap
- Hygienically packed in pairs



08

01

COB LED “Uniform” workshop light

Uniform, 190 x 63 x 38 mm

► Item no. 7981-70-46

► Product description

- LED rechargeable torch
- Flexible lamp head
- Strong magnet and hooks
-
- Dimensions: H 190 x W 63 x D 38 mm
- 2-stage switching: 1st stage: 100 lumen, 2nd stage: 200 lumen
- Practical belt holder with integrated suspension hook with pivoted splay foot,
- includes a strong magnet
- Water-tight (IP65)
- Light source: 2.4-W-COB-LED
- Burn time: 3 to 6 hours, depending on the setting
- Rechargeable battery: 3.7 V / 2,200 mAh Li-ion
- Charging time: 4 hours



01

Lamps



03

LED battery-powered pen working light

Chargeable with USB connection

► Item no. 7981-70-6

► Product description

- Service life: 2 hours
- Charging time: 1.5 hours
- Includes USB charging cable
- Main light: 7 SMD LED / spotlight: CREE XP-G2 R5
- Light intensity: 130 / 1,000 lux@0.5 m
- Luminous flux: 60 / 50 lumen
- Power supply: 3.7 V / 750 mAh Li-ion battery
- IP fuse type: IP54



03

02

Inspection lamp COB-LED

Mini shape, 117 x 59 x 13 mm

► Item no. 7981-70-36

► Product description

- LED pocket-sized lamp with rechargeable battery
- Rotating lamp head
- Strong magnet and hooks
- Two-stage switch
-
- Dimensions: H 117 x W 59 x D 13 mm
- 2-stage switching: 1st stage: 55 lumen, 2nd stage: 110 lumen
- Practical belt holder with integrated suspension hooks
- Burn time: 2.5 hours to 5 hours
- Rechargeable battery: 3.7 V/1000 mAh Li-ion
- Charging time: 2.5 hours
- Temperature range: -10° to +40°C
- Weight: 112 g IP20



02

04

LED inspection lamp

For checking brake pads

► Item no. 3721-503

► Product description

- Extra reinforced clip (non-slip)
- Aluminium housing
- Light source: 5 mm LED
- Length: 125 mm / ø of head 12 mm
- Includes batteries (2x AAA, micro)
- Constant light yield
- With instantaneous clip connection

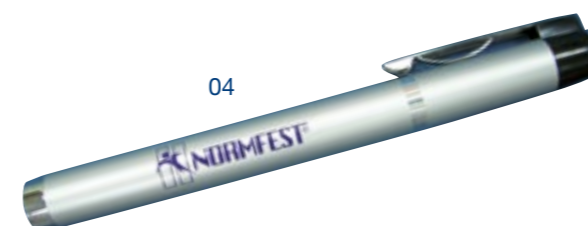

04

05

LED inspection lamp

Flashpen

► Item no. 7981-70-2

► Product description

- Extremely powerful LED with 100 lumens of output
- Focus feature with a 10° to 70° light cone
- Up to 75 m beam length
- Up to 6 hours of continuous use
- Waterproof to IP54
- Size (WxH): 16mm x 148mm
- Weight: 59g
- Includes two batteries (AAA/LR03/micro)



05

01

Inspection lamp for dent repairs

Incl. suction base

► Item no. 8714-610

► Product description

- Flexible use
- Can also be used as a hand lamp via the detachable flexible arm
- Paint-protecting 120 mm-diameter suction foot
- 300 mm long flexible arm with star handle
- Protects eyes thanks to prismatic protective glass

- 220/240 Volt with automatic switch-off
- 50/60 Hz
- 900 Lumen
- 210 mm light length
- Width: 38.5 mm
- Length: 65 mm
- 11 Watt fluorescent lamp
- 5m supply cable



02

LED workshop working lamp with rechargeable-battery and mains operation

Extremely robust and water tight

► Item no. 7981-70-61

► Technical specifications

- Rechargeable-battery and cable operation
- Daylight quality
- Robust housing made from die-cast aluminium
- Integrated carry handle
- Dimmer function
- Battery display
-
- 1-14 hour burn time
- 2-h charging time
- 5m cable / 2x0.75mm² H05RN-F
- 100-240 V AC - 50/60 Hz
- 11.1 V / 4,400 mAh Li-ion
- IP67
- IK07
- Weight: 2.2 kg
- Dimensions: 235 x 83 x 233 mm



03

Work lamp COB LED 30 W

Scangrip, 3300 Lumen

► Item no. 7981-70-60

► Product description

- Unbreakable, impact-, dust- and water-resistant
- Even illumination
- IP67 classification
- Includes flexible tripod
- Can be easily rotated or suspended
- Handle used for winding up the cable

Technical details:

30 W HIGH CRI COB LED
 3300 Lumen
 5000 Lux @ 50 cm
 LED life is at least 100,000 hours
 Operating voltage: 230 V AC
 Cable: 5 m (2x1 mm²H05RN-F)
 Dimensions: 261 x 274 x 76,5 mm
 Weight 2800 g

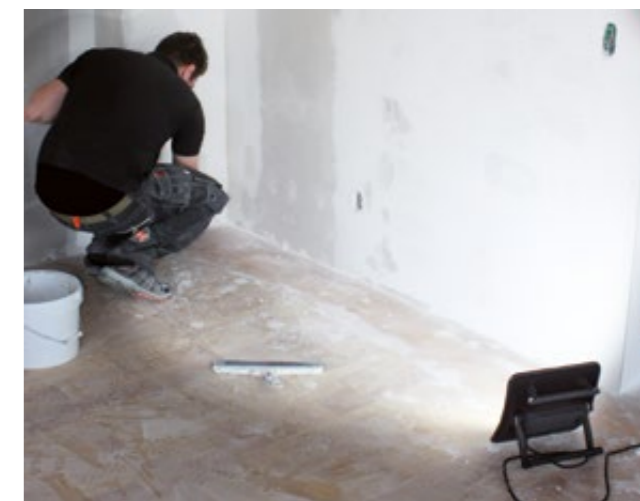

04

Tripod stand

Height adjustable from 1.1 to 2.5 m

► Item no. 7981-70-56

05

Holder for tripod stand

To fasten the work lamp COB LED (art. no. 7981-70-60)

► Item no. 7981-70-58





01
Disposable hand lamp
8 W

► Item no. 7981-66

► Product description

- 8 W, 220-240 V
- Anti-roll hexagonal shape
- Swivel hanging hook
- UV, oil and petroleum resistant
- 220-230 V, 50-60 Hz



02

LED torch inspection light

With robust, rotating hook

► Item no. 7981-70-66

► Product description

- 9 SMD LED, latest LED technology
- Brightness: 300 Lumen
- Luminance: 400 Lux at 0.5 m
- Tested to IP40, protected against solid foreign bodies of 1 mm and larger; The object probe (ball 1 mm) must not penetrate
- 5 m cable
- Weight: 650 g
- Dimensions: 26x40x340mm



03

LED engine-compartment lamp

Bonnet Light, Scangrip

► Item no. 7981-70-80

► Product description

- Very good light yield (1000 lumen)
- Bright, pleasant, flicker-free lighting
- Robust and watertight, IP65
- Two light settings (50 or 100 %)
- Magnetic, electronic switch
- Slim and compact
- Extremely light, just 1000 g including the holder
- Paintwork is protected by soft cover
- Adjustable telescopic holder (1.2 m to 1.7 m)
- Diameter of just 25 mm
- Burn time of one hour using rechargeable batteries
-

- Light source: 48 SMD-LEDs
- Light intensity: 1000 / 2000 Lux@0.5 m (stage 1/2)
- Luminous flux: 500/1000 lumen (stage 1/2)
- Illumination angle: 75°
- Dust- and water-tight to IP54
- Lifespan of the LED is at least 100,000 hours





**IT'S ALMOST UNBELIEVABLE
WHAT THIS PRODUCT CAN DO!**

**01
Organic binding agent for oil and chemicals
Suitable for indoor and outdoor use**

Oil-Catcher Premium

- ▶ Item no. 7874-150-1
- ▶ Contents: 1 litre
- ▶ Packing unit: 1

- ▶ Item no. 7874-150
- ▶ Contents: 50 litres
- ▶ Packing unit: 1

- ▶ **Technical specifications**
- Fast absorption of oils, chemicals, fuels, paints, and much more.
- Basis: Natural fibre
- pH value: 3.8
- Universally applicable
- For indoor and outdoor use
- Can be used in all conditions
- Reusable until complete saturation
- Non-toxic to humans, animals and the environment
- Can be used on any surface
- Economical and easy to use
- Easy to dispose of
- No long-term contamination of soils, water or aquifers
- No long-term physical or visual effect on the environment



01



**02
Oil binder
Oil-Catcher Outdoor**

- ▶ Item no. 7874-40
- ▶ Contents: 40 litre
- ▶ Packing unit: 1

- ▶ **Product description**
- An oil binder specially developed for outside use
- Has such a high weight of its own that there is no more drifting
- Grain: 0.125 - 4.0 mm



02

01

Workshop cleaner

Bio-Star

- ▶ Item no. 2897-250-5
- ▶ Contents: 5 litres
- ▶ Packing unit: 1

- ▶ Item no. 2897-250-30
- ▶ Contents: 30 litre
- ▶ Packing unit: 1

▶ **Product description**

- Highly active concentrate for cold and high-pressure cleaning
- Suitable for cleaning heavily soiled factory floors, walls and floor tiles
- Removes lubricating oil, grease, soot, pigments, resin and tar
- High-pressure cleaner mixing ratio: 1:3 to 1:5
- Mixing ratio for manual use: 1:1 to 1:5
- pH value: 11.2 (alkaline)
- AOX-free



01

Spout for 5 litre containers

- ▶ Item no. 2000-000-005

Spout for 30 litre containers

- ▶ Item no. 2000-000-030



02

Oil-stain remover

Oel-Ex

- ▶ Item no. 2897-341
- ▶ Contents: 400 ml
- ▶ Packing unit: 12

▶ **Product description**

- Effective aid against oil stains and old oil stains
- Removes oil stains from all absorbent and non-absorbent substrates, such as stone, natural stone and concrete blocks, clay and pumice, screed, clinker and ceramic
- Can also be used on carpets and textile flooring
- Colour: White
- Important: Do not use on bitumen, asphalt or slate!



02

EFFECTIVE HELPER AGAINST OIL AND WASTE-OIL STAINS!!!

01
Normfest-style batteries
Power, PU: 40 pieces

Item no.	Description	Voltage
3722-71	Mignon AA	1.5 V



01

02
Normfest-style batteries
Power, PU: 40 pieces

Item no.	Description	Voltage
3722-72	Micro AAA	1.5 V



02

03
High-energy batteries

Item no.	Voltage	Model	Figure
3722-01	1.5 volts	Mono D	1
3722-02	1.5 volts	Baby C	2
3722-03	1.5 volts	Mignon AA	3
3722-04	1.5 volts	Micro AAA	4
3722-05	9.0 volts	Block E	5



04
Batteries

Item no.	Voltage	Model	Figure
3722-24	12 volts	A 23, MN 21	1
3722-29	1.5 volts	LR 1, 4001	2



05
Rechargeable batteries

Item no.	Model	Figure
3722-40	800 mAh Micro AAA	1
3722-41	2100 mAh Mignon AA	2



06
Button cell batteries

Item no.	Description	Voltage	Item no.	Description	Voltage
3722-20	CR 2025	3 volts	3722-27	CR 1220	3 volts
3722-21	CR 2032	3 volts	3722-30	CR 1632	3 volts
3722-22	625 A, LR 9	1.5 volts	3722-31	V13 GA, LR 44	1.5 volts
3722-23	CR 2016	3 volts	3722-32	CR 2450	3 volts
3722-25	CR 1620	3 volts	3722-33	CR 1/3 N	3 volts
3722-26	CR 1616	3 volts			



06

07
Assortment of button cells

► Item no. 1957-580

Contents: 75 parts
 10 x CR1220 3V (art. no. 3722-27)
 10 x CR1616 3V (art. no. 3722-26)
 10 x CR1620 3V (art. no. 3722-25)
 10 x CR1632 3V (art. no. 3722-30)
 10 x CR2016 3V (art. no. 3722-23)
 10 x CR2025 3V (art. no. 3722-20)
 10 x CR2032 3V (art. no. 3722-21)
 5 x LR1 1.5V (4001) (art. no. 3722-29)



07



01
Cleaning paper roll
 2-ply, 1,000 tear-off sheets

- ▶ Item no. 7875-502
- ▶ 22 x 36 cm embossed, fully coated

- ▶ Item no. 7875-503
- ▶ 36 x 38 cm embossed, fully coated

- ▶ Product description
- Colour: blue
- PU: 2



01

02
Cleaning paper roll
 3-ply, 1,000 tear-off sheets

- ▶ Item no. 7875-504
- ▶ 38 x 36 cm

- ▶ Product description
- Layers: 3
- Tear-off sheets: 1,000 / roll
- Sheet size: 38 x 36 cm
- Roll diameter: 29cm
- Roll length: 350m
- Colour: blue
- embossed, fully bonded
- Packaging unit: 2 pieces



02

03
Rolls of lint-free fleece cloth
 500 tear-off sheets per roll, 38x30 cm

- ▶ Item no. 7875-505
- ▶ 38x30 cm

- ▶ Technical specifications
- Lint free
- Can be used wet and dry
- Biodegradable
- Components: 55% sawdust – 45% polyester (no binding agents)
- Colour: Turquoise
- Solvent resistant
- Highly absorbent
- Sold as a double roll
- 500 tear-off sheets per roll
- Sheet height: 38 cm
- Sheet width: 30 cm



03

04
Fibre fleece cleaning cloth
 perforated, 400 pcs. to tear off

- ▶ Item no. 7875-5
- ▶ 29 x 39 cm

- ▶ Product description
- Very absorbent
- High cotton content
- Can be wrung out
- Tear resistant
- Resistant to most solvents
- 2 rolls per pack
- 400 cloths per roll
- 29 x 38 cm
- Perforated for easy tearing
- Textile cloths (70% cotton, 15% synthetic fibres, 15% PP)



04

01

Fleece roll

perforated, 400 pcs. to tear off

- ▶ Item no. 7875-500
- ▶ 29 x 38 cm

▶ Product description

- Colour: White
- Highly absorbent
- Excellent tear and wear strength, wet or dry,
- Washable and wringable
- Solvent-resistant
- Silicone-free
- Food safe
- Perforated
- 400 perforations
- Roll length: 152m



01

02

Cellulose pads roll

2-ply, 600 pcs. to tear off

- ▶ Item no. 7875-1
- ▶ 27 x 40 cm, PU: 2

▶ Product description

- Roll length: 255 m
- Colour: white
- Very absorbent
- 2-ply
- Dimensions: 23.5 x 34 cm



02

03

Workshop refuse bags

120 litres

- ▶ Item no. 7875-908
- ▶ Colour: blue

▶ Product description

- 100 pieces on each roll
- 60 µm



03

04

Chrome wall mount

Max. roll width 75 cm

- ▶ Item no. 7875-901

▶ Product description

- For 3 compact rolls, max. roll width 75 cm
- Seat covers, compact rolls and rubbish bags
- H x W x D: 70 x 76 x 24 cm

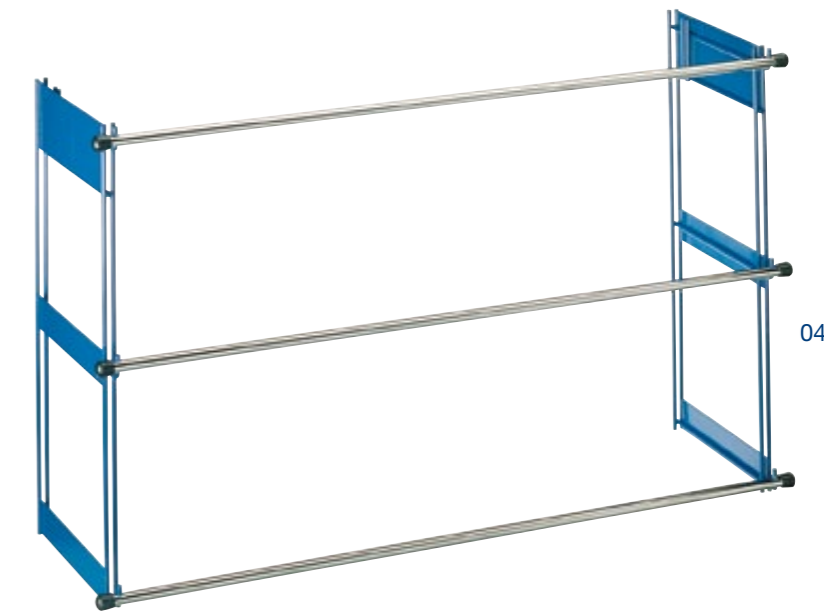

04

05

Cleaning paper floor stand

max. roll width 40 cm

- ▶ Item no. 7875-3



05

06

Chrome dispenser for cleaning paper

max. roll width 40 cm

- ▶ Item no. 7875-2



06

08

01

Protective seat covers

- ▶ Item no. 7875-902
- ▶ Roll each with 500 pcs.

- ▶ Item no. 7875-904
- ▶ Roll each with 100 pcs.

▶ **Product description**

- Dimensions: 82 cm x 130 cm
- Strength: 13my
- Roll of 500
- Perforated
- Also approved for seats with side airbags



01

02

Protective seat covers

Made from imitation leather

- ▶ Item no. 7875-920-000

▶ **Product description**

- Approved for seats with airbag functions
- Imitation leather
- Washable to 40°C
- Not suitable for pale leather seats!



02

03

Protective seat cover, anti-static

- ▶ Item no. 7875-905
- ▶ Roll each with 250 pcs.

▶ **Product description**

- Dimensions: 840 x 1400mm
- Permanently antistatic
- Roll of 250
- Approved for Daimlers



03

04

5-in-1 combi set, anti-static

- ▶ Item no. 7875-913
- ▶ Dispenser box of 100 sets

▶ **Product description**

- Floor mat white 50 cm x 38 cm paper
- Protective seat cover yellow 80 cm x 130 cm
- Steering wheel protector with drawstring white Length: 130 cm / width 10 cm
- Handbrake protector with white drawstring Length: 16 cm / width: 7 cm
- Gearstick protector with white drawstring Length: 13 cm / width: 14 cm



04



05

Compact roll 5 in 1

- ▶ Item no. 7875-911
- ▶ 250 sets on each roll

▶ **Product description**

- Seat cover PE white 840 x 1,400 mm
- Foot mat PE white non-slip 550 x 590 mm
- Steering wheel cover PE blue 490 x 150 mm
- With punched holes, gear lever and handbrake cover



05

01

Disposable foot mats

Plain

- ▶ Item no. 7875-510
- ▶ Roll each with 500 pcs.

- ▶ Product description
- Colour: white
- 70g/m²

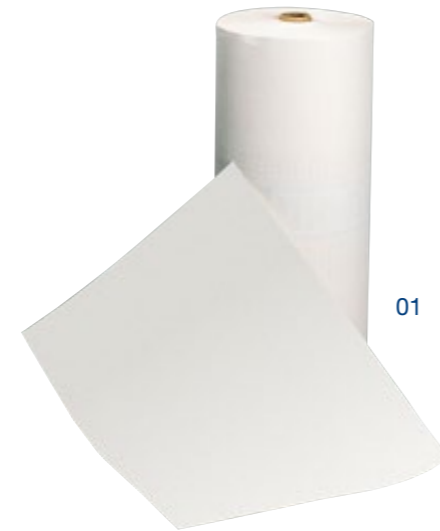

01

02

Duo foot mats

Disposable, perforated

- ▶ Item no. 7875-511
- ▶ 500 pcs. in a carton

- ▶ Product description
- No leakage of liquids and oils
- Very high tensile strength due to laminated, anti-static film
- 38 x 50 cm
- Paper: 70 g grey



02

03

Steering wheel covers roll

- ▶ Item no. 7875-900
- ▶ Steering wheel covers roll
- ▶ Item no. 7875-900-01
- ▶ Handle for steering wheel cover roll

- ▶ Product description
- Length: 300 cm
- Width: 14 cm
- Core inner diam.: 3.8 cm



03

04

Mudguard cover

Made from polyester

- ▶ Item no. 7875-921-8

- ▶ Product description
- With magnet
- 100 cm x 65 cm
- With two tool pockets



04

05

Mudguard cover

Made from imitation leather

- ▶ Item no. 7875-921-9

- ▶ Product description
- With magnet
- 100 cm x 65 cm



05

06

High temperature protective blanket

- ▶ Item no. 4982-001

- ▶ Product description
- Resistant to sparks and spatter
- Material: Glass filament fabric (flame-resistant, non-combustible)
- Weight: 3.5 kg
- Dimensions: 160 x 230 cm with fastening straps
- Thickness: 0.5 mm
- Heat resistant: up 750°C
- Elongation at break: 3%



06

07

Protective welding blanket

- ▶ Item no. 4982-000

- ▶ Product description
- Dimensions: 229 x 188.5 cm
- Heat resistant: up 700°C
- Max. radiation temperature: up to 1,000°C
- Abrasion and knick-proof



07



01
Electronic multifunctional battery charger
Telwin Doctor Charge 50

► Item no. 7771-12-30

► Product description

- "Pulse Tronic" automatic charging and trickle-charging
- Corresponds to the current-voltage characteristic (IUoU characteristic)
- Battery test to identify the voltage at the terminals, for example, or the starting capability (CCA) and for checking the functionality of the vehicle's own
- "Pulse Tronic" automatic charging and trickle-charging
- Corresponds to the current-voltage characteristic (IUoU characteristic)
- Battery test to identify the voltage at the terminals, for example, or the starting capability (CCA) and for checking the functionality of the vehicle's own
- alternator
- Revival and restoration of batteries, even exhausted ones
- Protection of on-board electronics when changing batteries, during diagnostics and in showroom mode
- Auxiliary start
- Effective charging current: 45 A conventional charging current (according to EU Regulation): 40 A
- Long power cable: 1.5m
- Long charging cable: 3m



01

02
Battery charging clips

Item no.	Model
7771-16-200	Red 200 A PCV
7771-16-201	Black 200 A PCV
7771-35-600	Red 600 A CV
7771-35-601	Black 600 A CV



02

03
Overvoltage protection

► Item no. 4982-500

► Product description

- For commercial vehicles and cars
- Suppresses voltage peaks
- LED connection display
- No unclamping of battery when welding
- No reprogramming of radio, clock, etc.
- Significant time savings



03

04
Battery jumper cables

Item no.	Ø / mm ²	Length	Figure
7771-16	16	3,0 m	2
7771-35	35 mit Überspannungsschutz	4,5 m	1
7771-50	50	5,0 m	2



04.1



04.2

01

Start booster - for cars and HGVs

▶ Item no. 7771-12-24

▶ Product description

- incl. charger 12-220 V (4.0 A)
- WITH pole protection
- Max. current: 12 V or 24 V, voltage selection per connector
- Peak power (SAE) 12 V/24 V: 7,000 A/3,500 A
- Start power 12 V/24 V: 2,300 A/1,150 A
- Charger voltage: 230 V
- Charging: 12 V 4 A
- Battery life*: 500 cycles (*based on 50% load shedding)
- Cable length: 182 cm
- Copper cable diameter: 50 mm²
- Number of integrated 500 A special batteries: 2
- Fully insulated terminal
- Protected against voltage peaks by 2x 500 A fuse
- Robust and impact-resistant ABS casing
- Flexible cable with fully insulated, solid copper tongs
- With LED load status tester



01

02

Start booster - for cars

▶ Item no. 7771-12

▶ Item no. 7771-12-10

▶ Spare charger for

Start Booster passenger vehicles 12 V

▶ Product description

- incl. charger 12-220 V (1.5 A)
- NO pole protection
- Max. current: 2,200 A
- Start power: 700 A
- Capacity: 12 V 22 Ah
- Gel battery
- Copper cable: Diameter 28 mm²
- Fully insulated clamps
- Protected against voltage peaks
- Cable length: 182 cm
- Weight: 8.3 kg

02

03

Cable reel

With robust frame

▶ Item no. 7771-100

▶ Product description

- Material: Plastic
- Reel diameter: 285 mm
- Cable length: 40 m
- Cable cross-section: 3G x 1.5 mm²
- Integrated thermostatic switch
- Area of use: For continuous outside use
- Splash-proof
- Tested to EN 61242



03

04

Automatic pneumatic hose reel

▶ Item no. 8699-7

▶ Product description

- Impact and UV-resistant plastic casing
- Compressed air hose designed for operating pressure up to 15 bar
- Long compressed air hose: 10 m
- Compressed air hose diameter: 8 mm
- Connection hose length: 2 m
- Swivelling wall holder made from solid steel
- Includes compressed-air fittings NW 7.2
- Not suitable for continuous use in a spray booth



04

05

Transmission jack hydraulics

Load bearing capacity: 300 kg

▶ Item no. 7714-300

▶ Product description

- Simple to position
- Foot operated
- Highly safe
- Versatile & extensive
- Highly stable
- Lift height: min. 1.23 m, max. 2.07 m



05

01

Parcel tape

66 m x 50 mm

- ▶ Item no. 4985-049
- ▶ Colour: brown

- ▶ Item no. 4985-050
- ▶ Colour: transparent

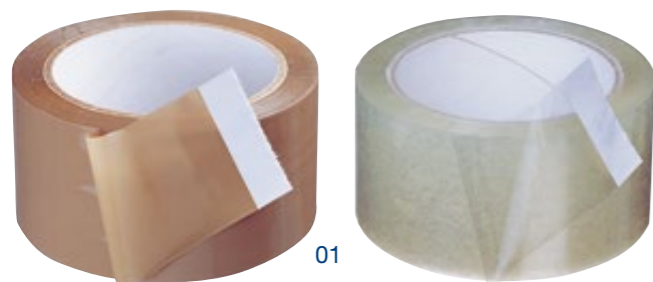

01

02

Parcel tape

„Caution - Glass“ warning tape

- ▶ Item no. 4985-052

- ▶ Product description
- For sealing and identification
- For fragile goods
- 66 m x 50 mm



02

03

Packaging tape dispenser

with brake

- ▶ Item no. 4985-051

- ▶ Product description
- For rolls up to 50 mm or 75 mm x 66 m

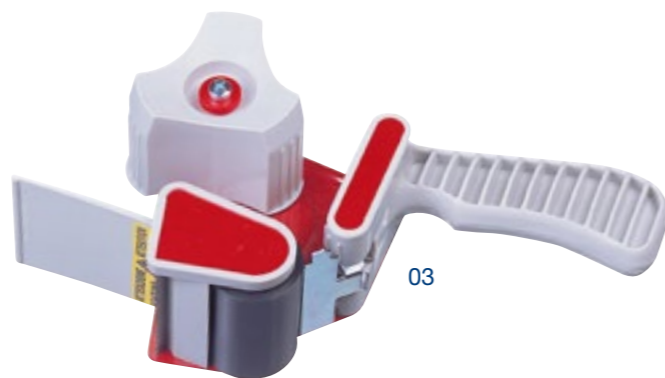

03

04

Safety knife

Martor quality

- ▶ Item no. 8715-57-604

- ▶ Item no. 8715-57-605
- ▶ Spare blades 10 pieces.



04



05

05

Cutter knife

incl. a spare blade

- | | |
|-------------|-------------------------|
| Item no. | |
| 8715-57-600 | |
| 8715-57-601 | Spare blades 10 pieces. |



06

06

Cutter knife

Material: sheet steel
length: 13 cm, width: 1 cm
blade width: 0.9 cm

- | | |
|-------------|-------------------------|
| Item no. | |
| 8715-57-602 | |
| 8715-57-603 | Spare blades 10 pieces. |

07

Replacement saw blades

For body saw (8696-1-60), optionally available

- ▶ Item no. 8696-112-551
- ▶ fine - 32 teeth, PU: 5

- ▶ Item no. 8696-112-552
- ▶ coarse - 24 teeth, PU: 5



07

08

Replacement saw blades-SIG

only for Wieländer and Schill saws

- ▶ Item no. 8696-112-554
- ▶ 24 teeth, PU: 5

- ▶ Item no. 8696-112-555
- ▶ 32 teeth, PU: 5



08

09

Replacement saw blades

For body saw (8696-1-60), optionally available

- ▶ Item no. 8696-113-71
- ▶ Sheet metal up to 2 mm (32 teeth), PU: 5

- ▶ Item no. 8696-113-72
- ▶ Steel/aluminium up to 5 mm (24 teeth), PU: 5

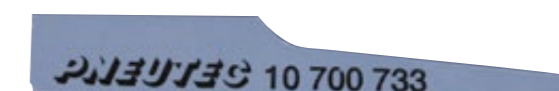

09

01

Flat brush

- ▶ Item no. 4693-1
- ▶ 1.0"

- ▶ Item no. 4693-15
- ▶ 1.5"

- ▶ Item no. 4693-2
- ▶ 2.0"



01

02

Ring brush with plastic frame

- ▶ Item no. 4693-02
- ▶ Size 2, Ø 1,5 cm

- ▶ Item no. 4693-04
- ▶ Size 4, Ø 2.0 cm

- ▶ Item no. 4693-06
- ▶ Size 6, Ø 2.5 cm

- ▶ Item no. 4693-08
- ▶ Size 8, Ø 3.0 cm

- ▶ Item no. 4693-010
- ▶ Size 10, Ø 3.5 cm



02

03

Brush

For body sealing compounds

- ▶ Item no. 4693-251-1



03

04

Liquid flux brush

Handle made of galvanised sheet metal

- ▶ Item no. 4693-500

- ▶ Product description

 - Pale bristles
 - Ø ferrule: 15 mm
 - Length: 140 mm
 - Height: 25 mm



04

05

Repair brush

Size 8

- ▶ Item no. 4693-311-5



05

06

Touch-up brush

In protective cover

- ▶ Item no. 4693-311-2



06



07

Flat brush

Angled head, 1.5"

- ▶ Item no. 4693-450-15



07

08

Brush

for tyre mounting paste

- ▶ Item no. 4693-080-0



08

09

Paint roller

Content: 5 rolls

- ▶ Item no. 4693-999

- ▶ Product description

 - Perfect, smooth primer surface thanks to macropores
 - Width: approx. 10cm
 - Diameter: approx. 3cm



09

01

Brake calliper brush

Smooth steel wire 0.35, particularly hard brush

- ▶ Item no. 8715-55-26
- ▶ For steel callipers
- ▶ Item no. 8715-55-27
- ▶ For aluminium callipers



01

02

Steel wire brush

- ▶ Item no. 4697-3
- ▶ 3-row
- ▶ Item no. 4697-4
- ▶ 4-row
- ▶ Item no. 4697-5
- ▶ 5-row



02

03

Oil can

White/Transparent, double-action brass pump, 0.2 litres

- ▶ Item no. 7713-000
- ▶ Product description
- Spray pipe, aluminium, curved



03

04

Funnel set

Oil, acid and petroleum resistant

- ▶ Item no. 2891-500-1
- ▶ Product description
- Resistant to oil, acid and fuel
- Versatile in use
- With handle
- Ø 50-75-100-120 mm



04

05

Funnel with strainer

Oil, acid and petroleum resistant

- ▶ Item no. 2891-500-5
- ▶ Product description
- With two-stage flexible outlet, detachable
- High overflow edge protects against splashes
- Interchangeable fine brass sieve
- Resistant to oil, acids and fuel



05

06

Measuring cups

oil-resistant and acidproof

- ▶ Item no. 2891-300-1
- ▶ 1 litre
- ▶ Item no. 2891-300-2
- ▶ 2 litres
- ▶ Item no. 2891-300-5
- ▶ 5 litres



06

07

Measuring cups

oil-resistant and acidproof

- ▶ Item no. 2891-400-05
- ▶ 0.5 litre, colour: orange
- ▶ Item no. 2891-400-1
- ▶ 1 litre
- ▶ Item no. 2891-400-2
- ▶ 2 litres
- ▶ Item no. 2891-400-3
- ▶ 3 litres
- ▶ Item no. 2891-400-5
- ▶ 5 litres



07

08

Gooseneck

for measuring cups with drain cocks

- ▶ Item no. 2891-400-050
- ▶ 0.5 litres
- ▶ Item no. 2891-400-10
- ▶ 1 litre
- ▶ Item no. 2891-400-20
- ▶ 2 litres
- ▶ Item no. 2891-400-30
- ▶ 3 litres



08



01

Floor module

with base panel and a universal shelf

▶ Item no. 7101-001-001

▶ Technical specifications

- Supporting force per shelf 20 kg
- Dimensions: H 544 x W 580 x D 340 mm
- RAL 7035 light grey



02

Floor module

with base panel without universal shelf

▶ Item no. 7101-001-000

▶ Technical specifications

- Supporting force per shelf 20 kg
- Dimensions: H 544 x W 580 x D 340 mm
- RAL 7035 light grey



03

Floor module

with three standard part shelves

▶ Item no. 7101-001-003

▶ Technical specifications

- Standard part shelves incl. 6 fixed and 12 variable dividing brackets
- Including base panel
- Dimensions in mm: H 544 x W 580 x D 340 mm
- RAL 7035 light grey



04

Floor corner module

Corner module with base panel and a universal shelf

▶ Item no. 7101-004-002

▶ Technical specifications

- Supporting force per shelf 20 kg
- Dimensions: H 444 x W 623 x D 623 mm
- RAL 7035 Light grey



01

Centre dividing module

3-compartment drawer module

▶ Item no. 7101-002-004

▶ Technical specifications

- Supporting force per drawer 8 kg
- Dimensions: H 444 x W 580 x D 340 mm
- RAL 7035 light grey



02

Centre dividing module

6-compartment drawer module

▶ Item no. 7101-002-006

▶ Technical specifications

- Supporting force per drawer 8 kg
- Dimensions: H 444 x W 580 x D 340 mm
- RAL 7035 light grey



05

Centre dividing module

Universal shelves, double

▶ Item no. 7101-002-000

▶ Technical specifications

- Supporting force per shelf 20 kg
- Dimensions: H 444 x W 580 x D 340 mm
- RAL 7035 light grey



06

Centre dividing module

Base with perforated plate

▶ Item no. 7101-002-003

▶ Technical specifications

- Supporting force per shelf 20 kg
- Dimensions: H 444 x W 580 x D 340 mm
- RAL 7035 light grey

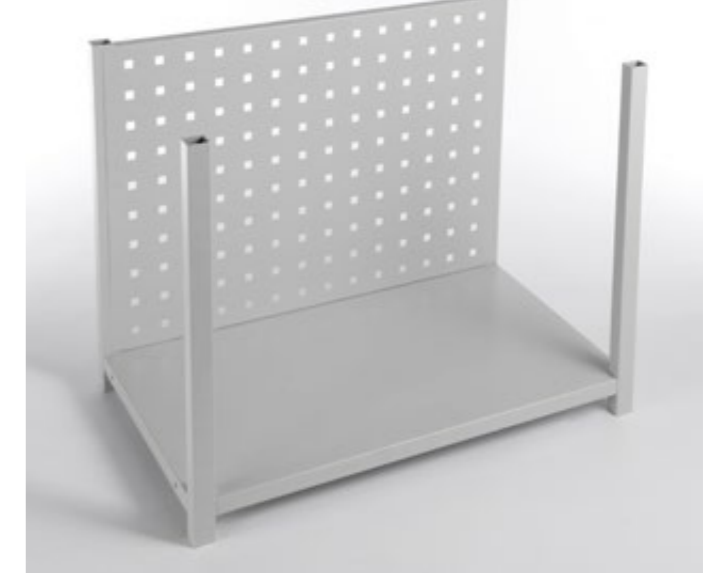

03

Centre dividing module

3-compartment standard parts module

▶ Item no. 7101-002-002

▶ Technical specifications

- Incl. 18 dividing brackets, variable adjustment options
- Dimensions: H 444 x W 580 x D 340 mm
- RAL 7035 light grey



04

Centre dividing module

Can module, 1 compartment

▶ Item no. 7101-002-001

▶ Technical specifications

- with can compartment shelf, 6 compartments
- Dimensions: H 444 x W 580 x D 340 mm
- RAL 7035 light grey



07

Universal corner module

Centre dividing module

▶ Item no. 7101-004-001

▶ Technical specifications

- Supporting force per shelf 20 kg
- Dimensions: H 444 x W 623 x D 623 mm
- RAL 7035 Light grey



08

Centre dividing module

Universal shelf, single

▶ Item no. 7101-002-007

▶ Technical specifications

- Supporting force per shelf 20 kg
- Dimensions: H 444 x W 580 x D 340 mm
- RAL 7035 light grey



01

Centre module

3-compartment drawer module, lockable

▶ Item no. 7101-002-005

▶ Technical specifications

- Supporting force per drawer 8 kg
- Dimensions: H 444 x W 580 x D 340 mm
- RAL 7035 light grey



02

Centre dividing module

Containers with 10 dividing panels

▶ Item no. 7101-002-009

▶ Technical specifications

- Universal tub incl. 10 variable dividing panels
- Compartment width 87 mm
- Dimensions: H 444 x W 580 x D 340 mm
- RAL 7035 light grey



03

End module

with universal compartment shelf

▶ Item no. 7101-003-000

▶ Technical specifications

- Supporting force per shelf 20 kg
- Dimensions: H 444 x W 580 x D 340 mm
- RAL 7035 light grey



04

End module

with two standard part compartment shelves

▶ Item no. 7101-003-003

▶ Technical specifications

- Standard part shelves incl. 4 fixed and 8 variable dividing brackets
- Hole distance 15 mm
- Dimensions: H 444 x W 580 x D 340 mm
- RAL 7035 light grey



05

End module

with universal compartment shelf

▶ Item no. 7101-004-000

▶ Technical specifications

- Supporting force per shelf 20 kg
- Dimensions: H 444 x W 580 x D 340 mm
- RAL 7035 Light grey



06

End module

with can compartment shelf, 6 compartments

▶ Item no. 7101-003-001

▶ Technical specifications

- Supporting force per shelf 20 kg
- Dimensions: H 444 x W 580 x D 340 mm
- RAL 7035 light grey



01

End module

with perforated board

▶ Item no. 7101-003-002

▶ Technical specifications

- Dimensions: H 444 x W 580 mm x D 340 mm
- Colour RAL 7035 light grey



02

Perforated board

Incl. fastening

▶ Item no. 7101-005-002

▶ Technical specifications

- Dimensions: H 896 x 336 mm
- Colour RAL 7035 light grey



03

Advertising panel

End module

▶ Item no. 7101-005-000



07

Car bulb cabinet module

Lockable

▶ Item no. 7101-002-008

▶ Technical specifications

- Storage of 56 car bulbs in foam inlay
- Two compartment shelves with a pitch of 68 mm
- Height-adjustable
- Lockable Plexiglass door
- Stable and high-quality steel construction
- Modular structure with virtually unlimited expansion options
- Fast and simple setup
- Individual planning options
- Optimised stock review and control
- Simple and rapid access to your goods
- Clearly laid-out and space-saving storage of car bulbs, DIN and standard parts, spray canisters, cartridges, fastening materials, workshop requirements and a wealth of other articles

08

Shelved cabinet module

Lockable cupboard

▶ Item no. 7101-001-002

▶ Technical specifications

- Three compartment shelves with a pitch of 68 mm
- Height-adjustable
- Lockable metal door
- Stable and high-quality steel construction
- Modular structure with virtually unlimited expansion options
- Fast and simple setup
- Individual planning options
- Optimised stock review and control
- Simple and rapid access to your goods
- Clearly laid-out and space-saving storage of car bulbs, DIN and standard parts, spray canisters, cartridges, fastening materials, workshop requirements and a wealth of other articles

04

Shelf connector

Incl. attachment set

▶ Item no. 7101-005-003



05

Wall anchoring set

▶ Item no. 7101-005-004



06

Threaded rod module

2-piece kit

▶ Item no. 7101-005-001



01

Mounting grid

Item no.	Dimensions Length x height	For storage boxes	
		Size 3	Size 4
7100-001-1	500 x 450 mm	9 x	16 x
7100-001-2	450 x 1000 mm	12 x	32 x
7100-001-3	1000 x 450 mm	18 x	36 x

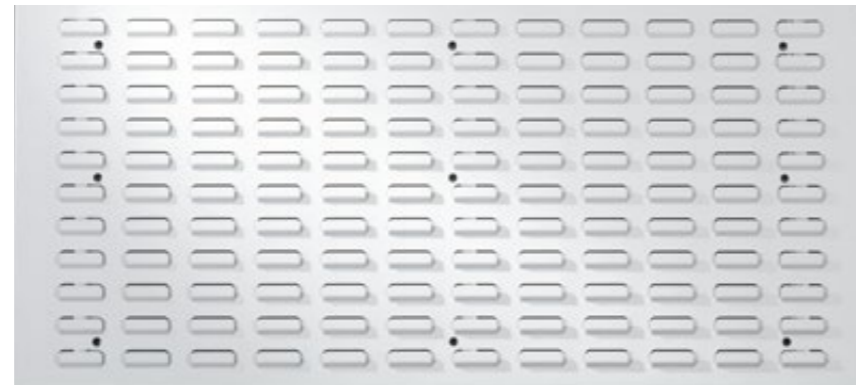

01

02

Perforated plate

Item no.	Dimensions
	Length x height
7100-000-1	500 x 450 mm
7100-000-2	1000 x 450 mm

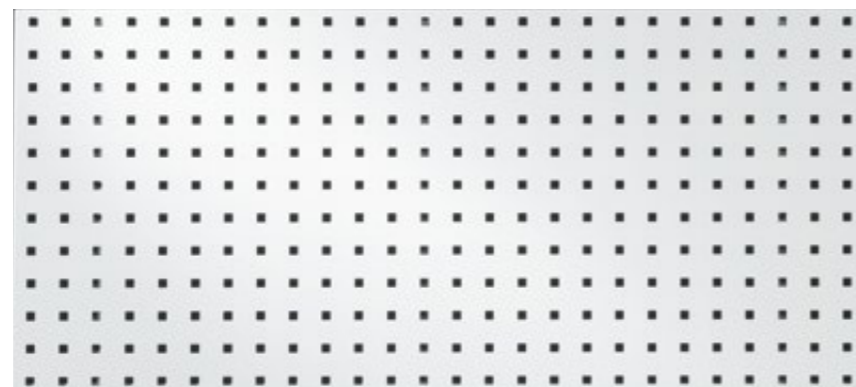

02

03

Cable dispenser

▶ Item no. 7100-002-02

▶ Product description

- Holds reels with up to 17 mm spindle size
- Colour: Aluminium colours
- Width: Max. 78/diameter 170 mm



03

04

Holder for petrol hose/shrink hose

▶ Item no. 7100-002-03

▶ Product description

- Dimensions: (WxD): 490 mm x 243 mm
- Colour: light grey



04

05

**Abrasive fleece holder
empty**

▶ Item no. 7100-002-07

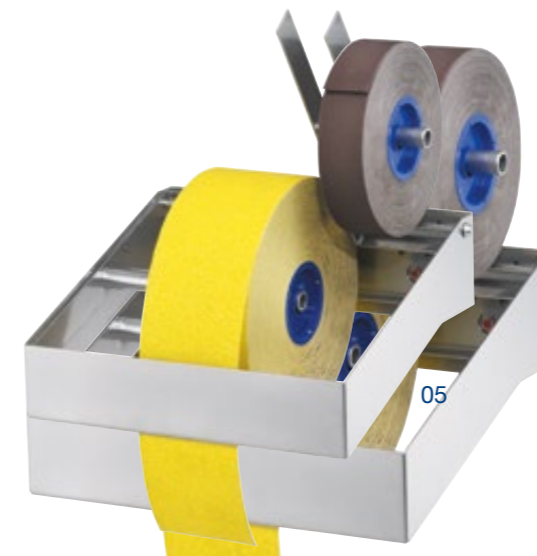

05

06

**Hose clamp display
empty**

▶ Item no. 7100-000

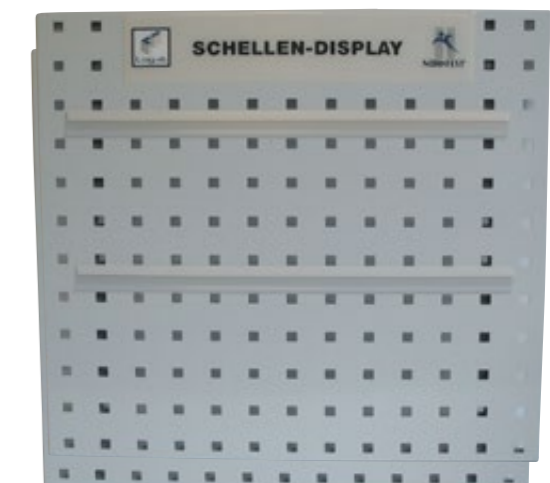

06

01

Tool holder
straight mandril

Item no.	Model
7100-000-304	150 mm

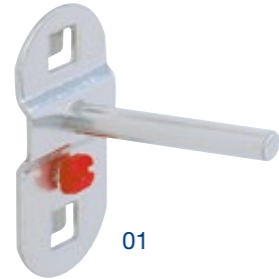

02

Tool clip
small

Item no.	Model
7100-000-305	19 mm



03

Tool holder
angled mandril

Item no.	Model
7100-000-301	50 mm
7100-000-302	100 mm
7100-000-3	150 mm
7100-000-303	200 mm



04

Round can holder
3 times

► Item no. 7100-000-6

► Product description

- Width: 300mm
- Ø 70mm
- Colour: aluminium-coloured

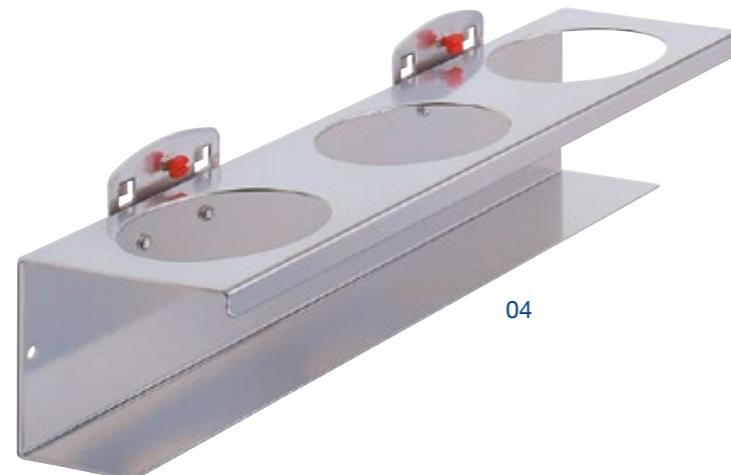

05

Inscription label strip self-adhesive

Item no.	Model
7100-000-5	430 mm
7100-000-7	940 mm



06

Magnetic labels

Width: 30 mm, length: 80 mm

► Item no. 1961-004-021

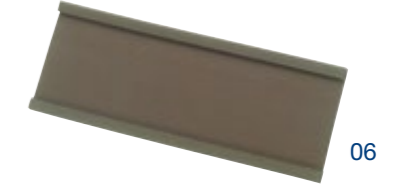

07

Magnetic tape roll

Length: 10.0 m, thickness: 0.65 mm

Item no.	Width
1961-004-201	20 mm
1961-004-251	25 mm



08

Velcro strips

Self-adhesive, 10 metre X 20 mm

► Item no. 3985-80



09

Holder bar for cans and bottles
empty

► Item no. 7100-002-01

► Product description

- Dimensions (HxWxD): 50 mm x 500 mm x 80 mm
- 2 oval holes 22/31 x 57 mm
- 3 round holes 51 mm
- 2 oval holes 20/27 x 46 mm
- 1 round hole 31 mm

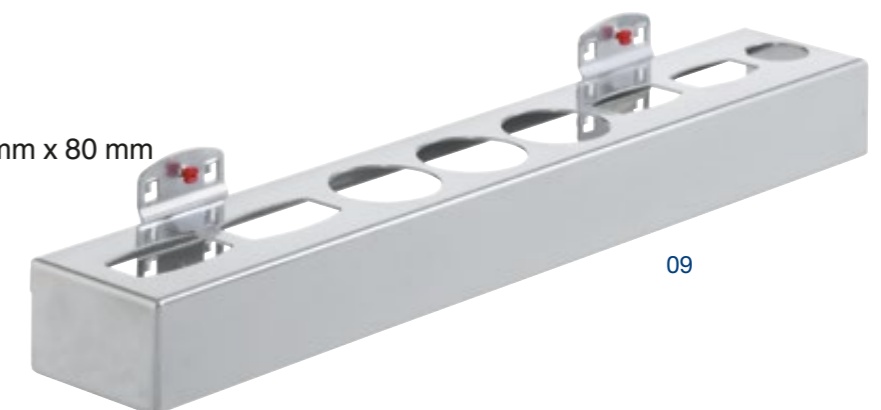

01

Storage box size 1

Length: 500/450 mm, width: 300 mm, height: 180 mm

Item no.	Colour
1962-1-1	blue
1962-2-1	grey



01

02

Storage box size 2

Length: 350/300 mm, width: 200 mm, height: 150 mm

Item no.	Colour
1962-1-2	blue
1962-2-2	grey



02

03

Storage box size 3

Width: 140 mm, height: 130 mm

Item no.	Colour
1962-1-3	blue
1962-2-3	grey



03

04

Storage box size 4

Suitable for mounting grid, length: 160/140 mm
width: 95 mm, height: 75 mm

Item no.	Colour
1962-1-4	blue
1962-2-4	grey



04

05

Storage boxes

Width: 188 mm, height: 80 mm

Item no.	Model
1961-945-31	5-compartment
1961-945-30	7-compartment
1961-945-36	9-compartment
1961-945-34	Separating wall
1961-945-291	Labels with protective film



05

06

Storage boxes

Width: 94 mm, height: 80 mm

Item no.	Model
1961-945-33	5-fold
1961-945-32	7-fold
1961-945-37	9-fold
1961-945-35	Partition wall
1961-945-29	Labels with protective film



06

07

Parts box

Width: 90 mm, height: 50 mm, length: 270 mm

Item no.	Model
1961-0	Parts box
1961-01	Partition wall
1961-02	Labels



07

Pneumatic tools



01

Impact wrench 1/2"

Lightweight yet suitable for numerous applications

▶ Item no. 8696-1-112

▶ Product description

***???* ATWBL Produktsatz:1

- Low weight: 2 kg
- High performance
- Forged DUOPACT striking mechanism
- With lubricating nipple for striking mechanism
- Robust left-hand / right-hand switch with output regulator
-
- Driving torque (inch): 1/2"
- Starting torque: 900 Nm
- Initial breakaway torque: 1,250 Nm
- Speed: 8.200 rpm
- Inner hose diameter: 8 mm
- Air inlet: 1/4" IT
- Vibration: 5.8 m/s²



01

02

Maintenance oil

1 litre

▶ Item no. 8696-112-810

▶ Pneumatic motor oil

▶ Item no. 8696-112-820

▶ Impact mechanism oil



02

03

Mini one-hand right angle grinder

Low-noise and vibration-free

▶ Item no. 8696-1-80

▶ Product description

- Compressed air fitting: 1/4"
- Sound pressure: 83 dB/A
- Air pressure: 6.3 bar
- Weight: 0.8 kg
- Speed: 18,000 rpm
- Chuck: 6 mm
- Average air consumption: 220 l/min

04

Required air connection 1/4"

▶ Item no. 8699-510-14

05

Adapter for 8696-1-80

▶ Item no. 4679-99-8



04

Pneumatic one-hand axial grinder

Low-noise and vibration-free

▶ Item no. 8696-1-79

▶ Product description

- Air fitting: 1/4"
- Sound pressure: 82.9 dB/A
- Air pressure: 6.3 bar
- Weight: 0.7 kg
- Rotational speed: 22,000 rpm
- Chuck: 6 mm



04

01

Pneumatic machine

ideal for stripe removal discs

► Item no. 4692-123

► Product description

- Weight: 1.1 kg
- Air pressure connection thread: 1/4" PT
- Rotational speed: 0-3,500 rpm
- Required flow pressure: 6.2 bar/90 psi
- Average air consumption: 17.5 CFM (500 l/min)



02

MBX starter kit

For the professional surface preparation

► Item no. 4692-900

► Product description

- Weight: 1.1 kg
- Air pressure connection thread: Rp 1/4"
- Hose diameter required: 3/8 ID (9.5 mm)
- Rotational speed: 0-3,500 rpm
- Required flow pressure: 6.2 bar/90 psi
- Required internal tube diameter: 9,5 mm
- Average air consumption: 17.5 CFM (500 l/min)
- Sound pressure level: 83 dB (DIN 45635-21; ISO 3744)

- Contents:

- 1 x 4692-123 MBX compressed-air machine
- 1 x 4692-211 MBX holder system 1 mm
- 1 x 4692-223 MBX holder system 23 mm
- 1 x 4692-523 MBX brush band, coarse 23 mm
- 1 x 4692-411 MBX brush band, medium 11 mm
- 1 x 4692 311 MBX brush band, fine 11 mm
- 1 x 4692-800 MBX film grinder



For working on aluminium bodywork.



For removing paint from contours.



For removing films from metal surfaces and paint without damage.

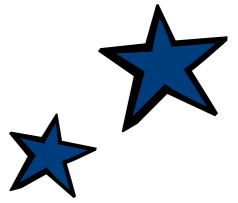

03

Pressure cup spray gun

for 1000 ml screw-top containers

► Item no. 2891-106-841

► Product description

- Ideal for use of Bottom-Guard and Protector
- Wide range of structures can be sprayed
- Teflon seals
- Suitable for metal



03

04

Body cavity spray hose set

For pneumatic pressure cup spray gun

► Item no. 2891-106-842

► Product description

- Specially designed for Protector
- Hose diameter: 6 mm
- Hose length: 98 cm (with handle, incl. adapter), 116 cm (without handle, incl. adapter)



04

01

UBS gun

Including nozzle and feed tube

► Item no. 2892-880

► Product description

- Quick & easy to assemble
- Accurately adjustable spray pattern
- Quick & easy to change
- No cleaning required

-

- Contents

- 1 x gun

- 2 x nozzles

- 1 x feed tube



02

Nozzle set

For UBS gun (article no. 2892-880)

► Item no. 2892-880-1

► Product description

- Nozzle set for UBS gun (article no. 2892-880)

- Content:

- 3 x nozzles

- 3 x feed tubes



03

Safety coupling

European profile 7.2 – 7.4 mm

► Product description

- safe connection and disconnection due to decompression mechanism ISO 4414 – DIN EN 983
- minimum force required for connection
- optimum leak tightness
- excellent flow rate which adapts to all pneumatic tools
- anti-static, prevents the build-up of dust particles on the surface when applying paint
- energy-absorbing composite material protects against scratches
- high-level resistance to abrasion, impacts, crushing and vibrations
- max. operating pressure: 16 bar
- operating temperature: -15°C to +70°C

Item no.	Description	Fitting	Figure
8699-200-16	Safety coupling with hose fitting	6.0 mm	1
8699-200-19	Safety coupling with hose fitting	9.0 mm	1
8699-200-113	Safety coupling with hose fitting	13.0 mm	1
8699-200-214	Safety coupling with external thread	1/4"	2
8699-200-238	Safety coupling with external thread	3/8 "	2
8699-200-212	Safety coupling with external thread	1/2"	2
8699-200-314	Safety coupling with internal thread	1/4"	3
8699-200-338	Safety coupling with internal thread	3/8"	3
8699-200-312	Safety coupling with internal thread	1/2"	3



01

Universal pneumatic gun

► Item no. 2891-010

► Product description

- Application of various cartridges possible
- Universal application for the use of sealants and adhesives
- Quick-release valve stops the flow of material immediately
- 70% more force than conventional pneumatic guns due to the ram piston technology
- Fill quantity: 300 ml to 320 ml cartridges, up to 400 ml bagged products
- Max. pressure: 10 bar
- Operating pressure: 5-10 bar

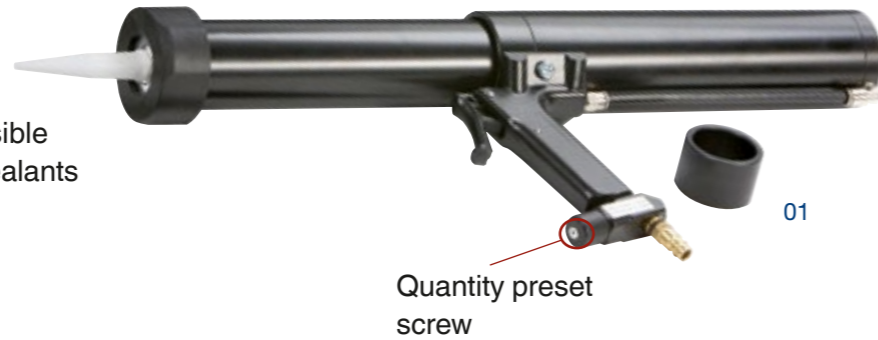

Quantity preset screw

01

02

Pneumatic gun Multi

Ideal for use with body sealing compounds, windscreen adhesives and sprayable seam sealants

► Item no. 2891-03

► Product description

- Complete gun body, incl. quick connector DN 7.2
- Union nut for sprayable seam sealants
- Union nut for standard applications
- 1.65 kg



Lock ring for sprayable seam sealants

Lock ring for bodywork sealants (cartridges)

Circulating-air regulating screw for injectable seam sealants

Quantity preset screw

02

03

For plastic cartridges

For use with body sealing compounds, windscreen adhesives and sprayable seam sealants

► Item no. 2891-03-1



03

03

Pneumatic cartridge gun

Ideal for use with sprayable seam sealants, e.g. Flexon (2893-300)

► Item no. 2891-05

► Product description

- Content:
- 1 x pneumatic cartridge gun
- 1 x nozzle set (10 long nozzles, 20 short nozzles)
- 1 x spare nozzle cap



03

05

Spare small spray tubes

► Item no. 2891-051

- Packaging unit: 30 pieces



05

04

Pneumatic blow-out gun

With 1/4" fitting

Item no.	Nozzle length
8696-113-9	2,5 cm
8696-113-90	22,0 cm



04

05

Pneumatic blow-out gun

With metal nozzle

► Item no. 8696-113-900

► Product description

- Nozzle: 110 mm long
- Diameter 3 x 6 mm
- Lightweight
- Robust and scratch-proof
- Foot: 23 Nm 3/h at 6 bar
- Input thread with brass insert 1/4" BSP toothed



05

01

PVC hose

With thermoplastic layers

► Product description

- Temperature range -20°C to +60°C



Item no.	Diameter internal/external	Length
8699-66-50	6,3 mm x 11,0 mm	50 m
8699-69-50	9,0 mm x 14,5 mm	50 m
8699-613-50	12,7 mm x 19,0 mm	50 m



01

Max. operating pressure at 20°C = 20 bar

02

PVC hose set

With thermoplastic layers

► Product description

- With quick-lock coupling and plug-type grommet
- Temperature range -20°C to +60°C
- Long service life
- Wear, shock and crush-proof
- Lightweight and flexible



02

Item no.	Diameter internal/external	Length
8699-201-6	6,3 mm x 11,0 mm	10 m
8699-201-9	9,0 mm x 14,5 mm	10 m
8699-201-13	12,7 mm x 19,0 mm	10 m

Max. operating pressure at 20°C = 20 bar

Fittings

Item no.	Model
8699-200-16	6 mm coupling
8699-200-19	9 mm coupling
8699-200-113	13 mm coupling

Item no.	Model
8699-25-520	6 mm nipple
8699-25-521	9 mm nipple
8699-25-522	13 mm nipple



03

Anti-static hose

Suitable for paint shops

► Product description

- With quick-lock coupling and plug-type grommet



Item no.	Diameter internal/external	Length
8699-201-916	9,0 mm x 16,0 mm	10 m



03

04

Spiral hose



Item no.	Diameter internal/external	Fitting	Length
8699-201-65	6,5 mm x 10,0 mm	1/4"	6 m
8699-201-8	8,0 mm x 12,0 mm	3/8"	8 m

Can be rotated 360°

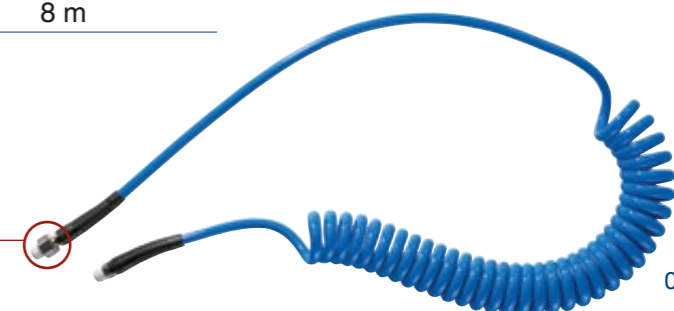

04

05

PTFE tape

for thread sealing

► Item no. 3985-030-160

► Product description

- Width: 12 mm
- Length: 12 m
- Thickness: 0.1 mm
- Heat resistant up to 240 - 250°C



05

Description	Item no.	Air connection mm	Wrench size mm	Total length mm	L1 mm	Fig.
Single-hand quick-connection coupler	8699-506	6	21	58		1
Single-hand quick-connection coupler	8699-509	9	21	58		1
One handed quick coupling with male thread	8699-541	G 1/4	22	39	9,0	2
One handed quick coupling with female thread	8699-514	G 1/4	22	41	9,0	3
Plug-type nipple with external thread	8699-520-14		17	33	9,0	4
Plug-type nipple with external thread	8699-520-38		19	33	9,0	4
Plug-type nipple with external thread	8699-520-12		24	38	12,0	4
Plug connection with female thread	8699-510-14	G 1/4	17	33	10,0	5
Double plug-type grommet DIN EN 560	8699-56	6		72	33,5	6
Double plug-type grommet DIN EN 560	8699-59	9		72	33,5	6
Double distributor internal thread	8699-530	G 3/8		67	18,0	7
Plug-type grommet hose connection	8699-526	6		48	25,0	8
Plug-type grommet hose connection	8699-529	9		48	25,0	8

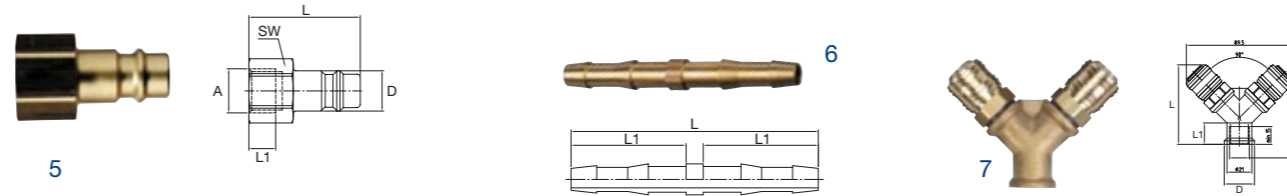
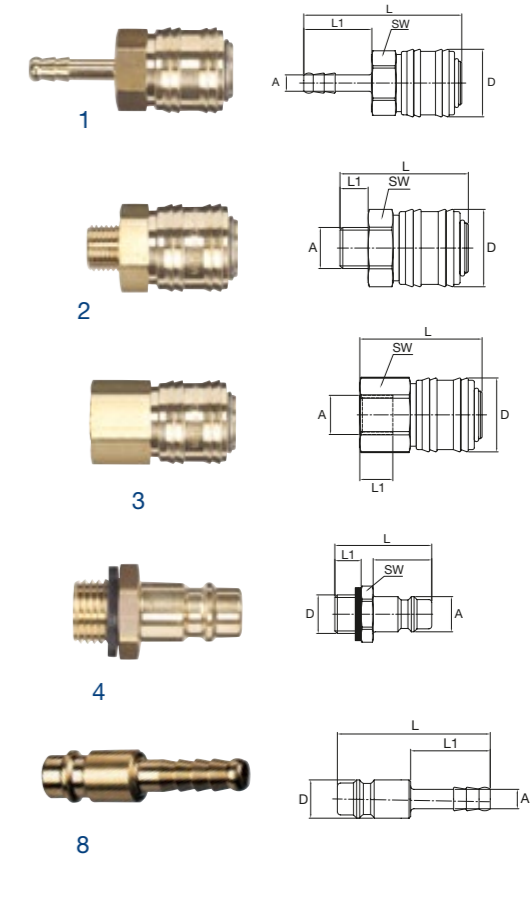

1 inch = 25.4 mm = 2.54 cm

Description	Item no.	Air fitting mm	Wrench size mm	Total length mm	Fig.
Plug-type nipple with external thread	8699-25-531	1/4"	14	37,0	1
Plug-type nipple with external thread	8699-25-532	3/8"	17	37,0	1
Plug-type nipple with external thread	8699-25-533	1/2"	22	43,0	1
Plug connection with female thread	8699-200-714	1/4"	15	40,0	2
Plug connection with female thread	8699-200-738	3/8"	21	41,0	2
Plug connection with female thread	8699-200-712	1/2"	27	41,0	2
Double plug-type grommet	8699-25-551	Ø 9			3
Double plug-type grommet	8699-25-552	Ø 13			3
Plug-type grommet hose connection	8699-25-520	Ø 6		44,5	4
Plug-type grommet hose connection	8699-25-521	Ø 9		54,0	4
Plug-type grommet hose connection	8699-25-522	Ø 13		51,5	4
Double distributor exterior thread	8699-200-702	1/2"	25	53,0	5 B

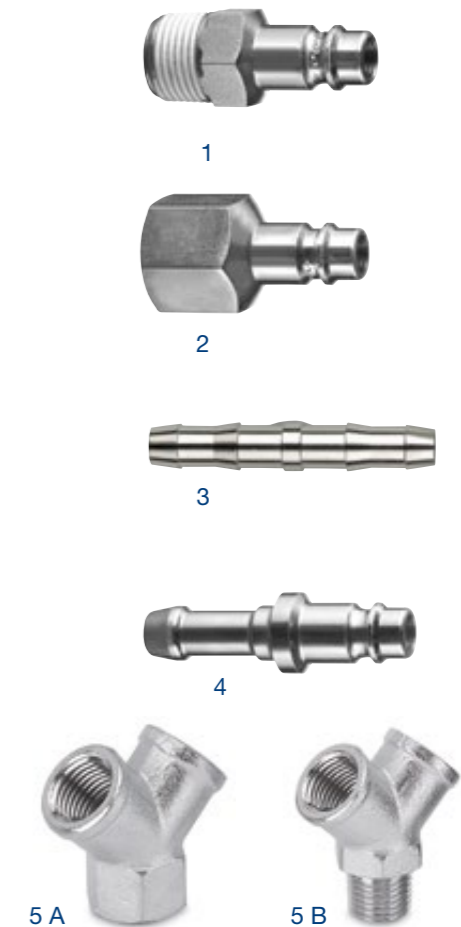

Tools





01

Excenter polishing machine

Tornador Ø 150 mm

▶ Item no. 8697-114-13

▶ Product description

- max. polishing pad diameter: 180 mm
- Max. supporting disk Ø: 150 mm
- Speeds: 1,700 - 4,200 rpm
- Eccentric movement: 21mm
- Power output: 900W
- 10-m cable
- Speed smoothly adjustable
- Detachable additional handle 240V/50Hz
- Weight: 4.28 kg



01

02

Mini angular polisher

With grip cover

▶ Item no. 8697-114-11

▶ Ø 160 mm

▶ Product description

- Max. supporting disk Ø: 125 mm
- Max. polishing pad diameter: 140 mm
- Weight: 1.9 kg
- Drive spindle: M14
- Power output 700 Watt
- Power consumption: 1,200 W
- Idle speed: 1,200 - 3,700 rpm



02

03

Polish Flex angle polisher

With powerful 1,400 Watt motor

▶ Item no. 8697-114-12

▶ Product description

- Max. polishing pad diameter: 200 mm
- Max. supporting disk Ø: 150 mm
- Idling speed: 380-2100 /min
- Power consumption: 1,400 W
- Power output: 880 Watt
- Tool retainer: M 14
- Dimensions (L x H): 402x117 mm
- Weight: 2.3 kg

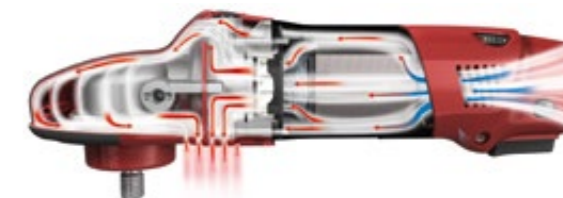

03

- A handle is included in the package
- The associated replacement carbon brushes are available under article number 8697-114-120



01

Windscreen cutter

▶ Item no. 8697-5

▶ Product description

- Rated input: 400 W
- Output: 220 W
- Oscillations: 11,000-18,500 1/min
- Cable with plug: 5 m
- Weight: 1.25 kg
- For windscreen specialists, car and truck workshops
- Fast, safe and easy-to-handle system
- Powerful 400 W motor for high cutting speeds
- Stepless electronic cutting frequency
- Hex tool holder with friction-locked connection between the machine and tool
- Supplied package:
 - 1 x Windscreen cutter Super Cut FSC
 - 1 x Plastic tool case 1 x whetstone (art no.:8697-5-1)
 - 1 x Spanner wrench (art no.: 8697-600)
 - 1 x Clamp screw



01

02

Round saw blades

▶ Product description

- For further use of the special cutter when sawing sheet metal and GRP as well as cutting scrap bridges (bodywork saw)



02

Item no.	Ø mm	Sales unit
8697-580-2	63	1
8697-581-2	80	1

Spare grindstone

▶ Item no. 8697-5-1

03

Hot air blower

2,300 W for hot air from 80-650°C

▶ Item no. 8697-000-992

▶ Product description

- Output: 2,300 W
- Temperature: 80°C-650°C
- Temperature display: Display, in 10°C increments
- Air volume: 150-500 l/min
- Heating: Ceramic heating
- Thermal protection cut-out: Yes
- Protection class (without protective earth connection): II
- Dimensions (LxWxH): 253 x 86.5 x 200 mm
- Mains connection: 230 V, 50/60 Hz
- Weight: 0.755 kg (without mains cable)



03

04

Hot melt gun

▶ Item no. 8714-607-1

▶ Product description

- Adhesive area firm and resilient after around just 2 min.
- High melting capacity
- Interchangeable nozzle
- Electronic temperature control thanks to modern PTC heating technology
- Easy handling thanks to mechanical feed device for glue sticks
- In attractive plastic case

- Dimensions (L x W x H): 185 x 30 x 160 mm
- Weight: 320g
- Output: Warm-up approx. 200 W
- Idle approx. 16 W
- In use approx. 45
- Mains voltage: 100 – 240
- Warm-up time: 7 min.
- Glue sticks: Ø11 mm, incl. 3 cartridges (article No. 8714-611-7 in black and 8714-611-9 in blue)
- Melt temperature: 206°C
- Output: approx. 16 g/min.



04

Glue-stick set

- ▶ Item no. 8714-611-7
- ▶ Glue stick set, black, PU: 5
- ▶ Item no. 8714-611-8
- ▶ Glue stick set, beige, PU: 6
- ▶ Item no. 8714-611-9
- ▶ Glue stick set, blue, PU: 6

01

Cordless cartridge gun

▶ Item no. 8715-999-110

▶ Item no. 8715-999-111

▶ Replacement battery

▶ Product description

- Voltage: 10.8V
- Expulsion force: 450kp
- Speed (mm/sec): 10mm/sec
- Weight: 2.195kg (battery 0.185kg)
- Charge time: 1 hour, switches off automatically



02

Light pressure hand gun

For processing up to 400 ml sealant cartridges and bags

▶ Item no. 2891-04

▶ Product description

- Robust metal locking ring with bayonet fitting
- No jamming of the push rod due to reinforced push plate
- For plastic bags and cartridges



01

Blind rivet nut pliers

▶ Item no. 8948-800

▶ Product description

- Equipment and accessories:

- Threaded mandrels + nuts M6, M8, M10, M12

- Work range: up to Ø 12 mm

- Weight: 1.1 kg

- Total length: 210 mm

- For processing blind rivet nuts,
M6 M12,
aluminium/steel/stainless steel

02

Mandrel and nut

for blind rivet nut pliers 8948-800

▶ Item no. 8948-800-14

▶ M4

▶ Item no. 8948-800-15

▶ M5

▶ Item no. 8948-800-16

▶ M6

▶ Item no. 8948-800-18

▶ M8

▶ Item no. 8948-800-110

▶ M10

▶ Item no. 8948-800-112

▶ M12



03

Water pump pliers set

Cobra

▶ Item no. 8714-02-08

▶ Product description

Set contents:

1 x water pump pliers 180 mm (8714-02-05)

1 x water pump pliers 250 mm (8714-02-06)

1 x water pump pliers 400 mm (8714-02-07)

- Self-locking on pipes and nuts: No slipping on the
workpiece, low hand force required

- Box-joint design: high stability due to double guide

- Guard prevents fingers being pinched

- Chrome vanadium, forged, oil-hardened

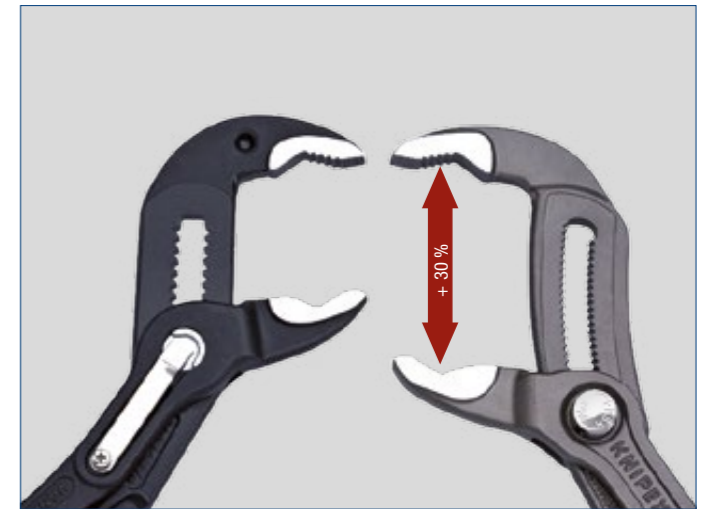

03

Item no.	Length	Tube Ø	Width across flats
8714-02-05	180 mm	1 ¼"	up to 30 mm
8714-02-06	250 mm	2"	up to 46 mm
8714-02-07	400 mm	3 ½"	up to 95 mm
8714-02-09	560 mm	4 ½"	up to 120 mm

04

Handsaw blade

HSS bi-metal, single-cutting edge

▶ Item no. 4601-300-13

▶ Product description

- Wear-proof, unbreakable, with excellent cutting
edge retention

- Recommended for all materials

Length	Width	Height	TEETH TO 1"
300 mm	13 mm	0,6 mm	24



04

05

Handsaw blade

HSS bi-metal, double-cutting edge

▶ Item no. 4601-300-25

▶ Product description

- Wear-proof, unbreakable, with excellent cutting
edge retention

- Recommended for all materials

Length	Width	Height	TEETH TO 1"
300 mm	25 mm	0,8 mm	22



05



01

Thread cutting unit

For metric thread in accordance with DIN 13, 44 parts

► **Item no. 8639-02**

- Contents: 44 pieces
- 3 of each manual thread cutters DIN 352, HSSG: M3, M4, M5, M6, M8, M10, M12
- 1 of each die nut DIN 223, HSS: M3, M4, M5, M6, M8, M10, M12
- 1 of each adjustable tap wrench DIN 1814: Size 1 and 2
- 1 of each tap-wrench holder DIN 225: 20 x 5 mm, 20 x 7 mm, 25 x 9 mm, 30 x 11 mm, 38 x 14 mm
- 1 of each core-removing twist drill DIN 338, HSS: 2.5 mm, 3.3 mm, 4.2 mm, 5.0 mm, 6.8 mm, 8.5 mm, 10.2 mm
- 1 of each screwdriver and thread gauge



01

02

Tap wrench adjustable

DIN 1814, for hand taps with square ends in accordance with DIN10 and ISO/R237



02

Item no.	For thread	For square-end	Length
8657-1	M1 - 10	2,1 - 5,5	180 mm
8657-2	M4 - 12	3,8 - 7,0	280 mm
8657-3	M5 - 20	4,9 - 12,0	390 mm

03

Tool holder with ratchet

Long version, for hand taps for right and left-hand threads



03

Item no.	For thread	For square-end	Length
8715-42-03	M3 - 8	2,4 - 4,9	250 mm
8715-42-04	M8 - 12	4,9 - 7,0	300 mm

04

Tool holder with ratchet

Short version, for hand taps for right and left-hand threads

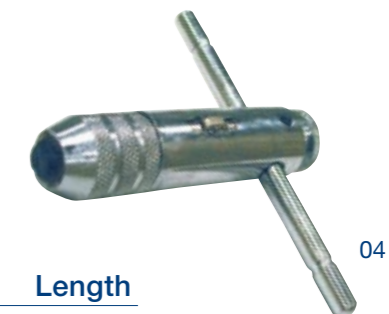

04

Item no.	For thread	For square-end	Length
8715-42-01	M3 - 8	2,4 - 4,9	85 mm
8715-42-02	M8 - 12	4,9 - 7,0	100 mm

01

Hand tap sets

DIN 352 HSS, ISO metric standard thread, taper tap, second tap, bottom tap

Item no.	Thread
8639-4	M4
8639-5	M5
8639-6	M6
8639-8	M8
8639-10	M10
8639-12	M12
8639-14	M14
8639-16	M16
8639-18	M18



02

Taper tap

DIN 352 HSS

Item no.	Thread
8640-1-6	M6
8640-1-7	M7
8640-1-8	M8
8640-1-10	M10
8640-1-20	M20
8640-1-22	M22
8640-1-24	M24



03

Second tap

DIN 352 HSS

Item no.	Thread
8640-2-5	M5
8640-2-6	M6
8640-2-8	M8
8640-2-10	M10
8640-2-18	M18
8640-2-20	M20
8640-2-24	M24



04

Bottoming tap

DIN 352 HSS

Item no.	Thread
8640-3-4	M4
8640-3-5	M5
8640-3-6	M6
8640-3-8	M8
8640-3-10	M10
8640-3-12	M12
8640-3-20	M20
8640-3-22	M22



05

Fine-pitch thread**taper tap**

DIN 2181 HSS

Item no.	Thread
8642-118-15	M18
8642-120-15	M20
8642-124-15	M24



06

Fine-pitch thread**bottoming tap**

DIN 2181 HSS

Item no.	Thread
8642-310-1	M10 x 1,00
8642-310-125	M10 x 1,25
8642-312-125	M12 x 1,25
8642-312-15	M12 x 1,50
8642-314-125	M14 x 1,25
8642-314-15	M14 x 1,50



07

Hand tap**sets**

DIN 2181 HSS, ISO metric fine thread, taper tap, bottom tap

Item no.	Thread	Item no.	Thread
8641-8-1	M8	8641-14-125	M14
8641-10-1	M10	8641-14-15	M14
8641-10-125	M10	8641-16-15	M16
8641-12-125	M12	8641-18-15	M18
8641-12-15	M12		

**Thread specifications description**

DIN 352 HSS, for ISO metric standard thread

Thread	pitch mm	core hole diam. mm	L mm	threaded length mm	shaft mm	4 kt. diam.
M4	0.70	3.3	45	14	4.5	3.4
M5	0.80	4.2	48	16	6.0	4.9
M6	1.00	5.0	50	19	6.0	4.9
M7	1.00	6.0	50	19	6.0	4.9
M8	1.25	6.8	56	22	6.0	4.9
M10	1.50	8.5	70	24	7.0	5.5
M12	1.75	10.2	75	29	9.0	7.0
M14	2.00	12.0	80	30	11.0	9.0
M16	2.00	14.0	80	32	12.0	9.0
M18	2.50	15.5	95	40	14.0	11.0
M20	2.50	17.5	95	40	16.0	12.0
M22	2.50	19.5	100	40	18.0	14.5
M24	3.00	21.0	110	50	18.0	14.5

Thread specifications description

DIN 2181 HSS, for ISO metric fine thread

Thread	pitch mm	core hole diam. mm	L mm	threaded length mm	shaft mm	4 kt. diam.
M4	0.70	3.3	45	14	4.5	3.4
M5	0.80	4.2	48	16	6.0	4.9
M6	1.00	5.0	50	19	6.0	4.9
M7	1.00	6.0	50	19	6.0	4.9
M8	1.00	6.8	56	22	6.0	4.9
M10	1.50	8.5	70	24	7.0	5.5
M12	1.75	10.2	75	29	9.0	7.0
M14	2.00	12.0	80	30	11.0	9.0
M16	2.00	14.0	80	32	12.0	9.0
M18	2.50	15.5	95	40	14.0	11.0
M20	2.50	17.5	95	40	16.0	12.0
M22	2.50	19.5	100	40	18.0	14.5
M24	3.00	21.0	110	50	18.0	14.5

01

Die nut

DIN 223 HSS, for ISO metric standard thread in accordance with DIN 13, type B (closed, pre-slotted)

Item no.	Thread	Pitch mm	Ø mm	Height mm
8652-6	M6	1,00	20	7
8652-8	M8	1,25	25	9
8652-10	M10	1,50	30	11
8652-12	M12	1,75	38	14



01

02

Die nut

DIN 223 HSS, for ISO metric fine thread in accordance with DIN 13, type B (closed, pre-slotted)

Item no.	Thread	Pitch mm	Ø mm	Height mm
8652-10-125	M10 x 1,25	1,25	30	11
8652-12-125	M12 x 1,25	1,25	38	11
8652-12-15	M12 x 1,50	1,50	38	10
8652-14-15	M14 x 1,50	1,50	38	10
8652-16-15	M16 x 1,50	1,50	45	14



02

03

Die holder

DIN 225 for direct mounting of dies

Item no.	Treading die Ø	Suitable for
8659-5	38 x 14,0	M12 - 14



03



DIN and standardised



01

Sheet metal screw

Tallow-drop with cross head
DIN 8041 / ISO 7049
galvanized
Strength class 4.8



Artikel-Nr.	Length	Head Ø
6115-35-19	19 mm	6.9 mm
6115-42-22	22 mm	8.2 mm
6115-63-60	60 mm	12.5 mm
6115-55-13	13 mm	10.8 mm
6115-63-19	19 mm	12.5 mm
6115-63-16	16 mm	12.5 mm
6115-42-19	19 mm	8.2 mm
6115-35-95	9.5 mm	6.9 mm
6115-48-16	16 mm	9.5 mm
6115-48-95	9.5 mm	9.5 mm
6115-48-13	13 mm	9.5 mm
6115-48-32	32 mm	9.5 mm
6115-42-25	25 mm	8.2 mm
6115-39-13	13 mm	7.5 mm
6115-48-19	19 mm	9.5 mm
6115-48-25	25 mm	9.5 mm
6115-39-16	16 mm	7.5 mm
6115-42-95	9.5 mm	8.2 mm
6115-55-38	38 mm	10.8 mm
6115-39-19	19 mm	7.5 mm
6115-42-16	16 mm	8.2 mm
6115-55-22	22 mm	10.8 mm
6115-35-16	16 mm	6.9 mm
6115-55-19	19 mm	10.8 mm
6115-35-13	13 mm	6.9 mm
6115-63-25	25 mm	12.5 mm
6115-55-16	16 mm	10.8 mm
6115-29-95	9.5 mm	5.6 mm
6115-48-22	22 mm	9.5 mm
6115-63-22	22 mm	12.5 mm
6115-42-13	13 mm	8.2 mm
6115-42-38	38 mm	8.2 mm

02

Chipboard screw

with flat head and Torx
(T-multidrive) T30
zinc-plated



Artikel-Nr.	Length	Head Ø
6198-030-16	16 mm	6 mm
6198-030-20	20 mm	6 mm
6198-035-16	16 mm	7 mm
6198-035-20	20 mm	7 mm
6198-035-30	30 mm	7 mm
6198-035-35	35 mm	7 mm
6198-035-40	40 mm	7 mm
6198-040-20	20 mm	8 mm
6198-040-25	25 mm	8 mm
6198-040-35	35 mm	8 mm
6198-040-45	45 mm	8 mm
6198-040-50	50 mm	8 mm
6198-050-100	100 mm	10 mm
6198-050-20	20 mm	10 mm
6198-050-30	30 mm	10 mm
6198-050-40	40 mm	10 mm
6199-4-45	45 mm	7.5 mm
6199-5-50	50 mm	9.2 mm

03

Wing drilling screw

Flat head, Torx drive T30
galvanised



Artikel-Nr.	Length	Head Ø
6212-55-45	45 mm	12 mm
6212-63-60	60 mm	12 mm
6212-55-55	55 mm	12 mm
6212-55-38	38 mm	12 mm
6212-63-70	70 mm	12 mm

04

Hexagon sheet metal bolt

with washer
zinc-plated
yellow chrome-plated
DIN 7976

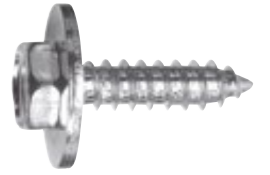

Artikel-Nr.	Length	Head Ø
6129-948-19	19 mm	10 mm
6129-65-20	20 mm	10 mm
6129-63-25	20 mm	10 mm
6129-56-13	13 mm	8 mm
6129-55-19	19 mm	8 mm
6129-55-16	16 mm	8 mm
6129-63-16	16 mm	10 mm
6129-48-13	13 mm	8 mm
6129-8-19	19 mm	13 mm
6129-48-16	16 mm	8 mm
6129-65-16	16 mm	10 mm
6129-48-19	19 mm	8 mm

This is how to measure screws correctly!

Countersunk screws = total length
Other screws = up to the head



01

Drilling screw

Fillister head with cross slot
DIN 7504
galvanised



Artikel-Nr.	Length	Head Ø
6211-39-19	19 mm	7.5 mm
6211-48-16	16 mm	9.5 mm
6211-55-22	22 mm	10.8 mm
6211-35-19	19 mm	6.9 mm
6211-42-19	19 mm	8.2 mm
6211-42-25	25 mm	8.2 mm
6211-48-19	19 mm	9.5 mm
6211-065-19	19 mm	
6211-48-22	22 mm	9.5 mm
6211-42-16	16 mm	8.2 mm
6211-55-19	19 mm	10.8 mm
6211-065-16	16 mm	
6211-42-13	13 mm	8.2 mm
6211-35-16	16 mm	6.9 mm
6211-63-25	25 mm	10.8 mm
6211-48-13	13 mm	9.5 mm
6211-35-13	13 mm	6.9 mm
6211-48-32	32 mm	9.5 mm
6211-63-22	22 mm	10.8 mm
6211-63-19	19 mm	10.8 mm
6211-39-13	13 mm	7.5 mm
6211-39-16	16 mm	7.5 mm
6211-065-25	25 mm	
6211-48-25	25 mm	9.5 mm
6211-48-45	45 mm	9.5 mm
6211-35-95	9.5 mm	6.9 mm
6211-42-22	22 mm	8.2 mm

02

Sheet metal screw

Tallow-drop with crosshead
DIN 7981 / ISO 7049
black galvanised



Artikel-Nr.	Length	Head Ø
6134-29-13	13 mm	5.6 mm
6134-48-22	22 mm	9.5 mm
6134-42-19	19 mm	8.2 mm
6134-39-16	16 mm	7.5 mm
6134-35-95	9.5 mm	6.9 mm
6134-48-25	25 mm	9.5 mm
6134-35-13	13 mm	6.9 mm
6134-55-25	25 mm	10.8 mm
6134-48-32	32 mm	9.5 mm
6134-48-19	19 mm	9.5 mm
6134-42-22	22 mm	8.2 mm
6134-42-13	13 mm	8.2 mm
6134-35-16	16 mm	6.9 mm
6134-48-16	16 mm	9.5 mm
6134-42-25	25 mm	8.2 mm
6134-39-25	25 mm	7.5 mm
6134-55-19	19 mm	10.8 mm
6134-42-95	9.5 mm	8.2 mm
6134-55-16	16 mm	10.8 mm
6134-39-95	9.5 mm	7.5 mm
6134-35-19	19 mm	6.9 mm
6134-48-13	13 mm	9.5 mm
6134-29-19	19 mm	5.6 mm
6134-42-16	16 mm	8.2 mm
6134-48-95	9.5 mm	9.5 mm
6134-39-22	22 mm	7.5 mm
6134-29-95	9.5 mm	5.6 mm
6134-39-13	13 mm	7.5 mm
6134-39-19	19 mm	7.5 mm

03

Sheet metal screw

with collar (flat head)
similar to DIN 7981
galvanised black



Artikel-Nr.	Length	Head Ø
6134-048-22	22 mm	11.5 mm
6134-048-19	19 mm	11.5 mm
6134-039-22	22 mm	10 mm
6134-048-95	9.5 mm	11.5 mm
6134-048-25	25 mm	11.5 mm
6134-042-13	13 mm	10.5 mm
6134-042-19	19 mm	10.5 mm
6134-048-13	13 mm	11.5 mm
6134-048-32	32 mm	11.5 mm
6134-039-16	16 mm	10 mm
6134-042-16	16.0 mm	10.5 mm
6134-039-13	13 mm	10 mm
6134-042-25	25 mm	10.5 mm
6134-039-38	38 mm	10 mm
6134-042-38	38 mm	10.5 mm
6134-039-95	9.5 mm	10 mm
6134-048-16	16 mm	11.5 mm
6134-039-19	19 mm	10 mm
6134-042-95	9.5 mm	10.5 mm
6134-039-25	25 mm	10 mm
6134-042-22	22 mm	10.5 mm

04

Hexagon bolt

with collar and countersunk head
similar to DIN 7504-K
galvanised



Artikel-Nr.	Length	Head Ø
6214-48-19	19 mm	10.5 mm
6214-48-16	16 mm	10.5 mm

This is how to measure screws correctly!

**Countersunk screws = total length
Other screws = up to the head**



01

Hexagon bolt

Thread to head

quality 8.8

DIN 933 / ISO 4017

galvanised

Artikel-Nr.	Length
6057-6-30	30 mm
6057-12-20	20 mm
6057-14-45	45 mm
6057-10-110	110 mm
6057-6-25	25 mm
6057-14-50	50 mm
6057-8-45	45 mm
6057-14-120	120 mm
6057-8-25	25 mm
6057-8-12	12 mm
6057-4-30	30 mm
6057-12-30	30 mm
6057-10-16	16 mm
6057-8-16	16 mm
6057-16-80	80 mm
6057-20-90	90 mm
6057-8-10	10 mm
6057-14-100	100 mm
6057-4-20	20 mm
6057-6-50	50 mm
6057-8-20	20 mm
6057-6-70	70 mm
6057-16-40	40 mm
6057-12-55	55 mm
6057-12-100	100 mm
6057-12-50	50 mm
6057-4-16	16 mm
6057-20-120	120 mm
6057-8-55	55 mm
6057-4-10	10 mm
6057-10-55	55 mm
6057-20-55	55 mm
6057-10-50	50 mm
6057-20-35	35 mm
6057-5-60	60 mm
6057-16-55	55 mm
6057-16-50	50 mm
6057-14-60	60 mm
6057-6-12	12 mm
6057-10-40	40 mm
6057-14-70	70 mm

Artikel-Nr.	Length
6057-10-70	70 mm
6057-12-40	40 mm
6057-8-90	90 mm
6057-12-25	25 mm
6057-10-65	65 mm
6057-6-20	20 mm
6057-6-18	18 mm
6057-8-75	75 mm
6057-5-30	30 mm
6057-6-45	45 mm
6057-12-45	45 mm
6057-8-80	80 mm
6057-5-10	10 mm
6057-8-40	40 mm
6057-5-50	50 mm
6057-12-110	110 mm
6057-6-35	35 mm
6057-6-80	80 mm
6057-16-30	30 mm
6057-16-120	120 mm
6057-12-60	60 mm
6057-8-50	50 mm
6057-5-16	16 mm
6057-10-80	80 mm
6057-5-12	12 mm
6057-12-70	70 mm
6057-12-80	80 mm
6057-12-35	35 mm
6057-6-40	40 mm
6057-10-25	25 mm
6057-5-35	35 mm
6057-10-45	45 mm
6057-5-20	20 mm
6057-4-25	25 mm
6057-10-30	30 mm
6057-8-65	65 mm
6057-4-40	40 mm
6057-8-70	70 mm
6057-8-35	35 mm
6057-10-20	20 mm
6057-10-90	90 mm



02

Carriage bolt

With square and hex nut

Strength 4.8

DIN 603 / ISO 8677

galvanized



Artikel-Nr.	Length	Head Ø
6223-10-40	40 mm	24 mm
6223-8-40	40 mm	20 mm
6223-8-60	60 mm	20 mm
6057-10-35	35 mm	
6057-10-60	60 mm	
6057-12-90	90 mm	
6057-10-100	100 mm	
6057-6-10	10 mm	
6057-16-70	70 mm	
6057-5-40	40 mm	
6057-14-40	40 mm	
6057-14-80	80 mm	
6057-16-100	100 mm	
6057-6-55	55 mm	
6057-16-60	60 mm	
6057-5-45	45 mm	
6057-18-35	35 mm	
6057-8-30	30 mm	
6057-6-22	22 mm	
6057-6-16	16 mm	
6057-14-35	35 mm	
6057-6-60	60 mm	
6057-5-25	25 mm	
6057-8-60	60 mm	

01

Self-locking screw with serrated bearing surface

Quality 8.8
Gavanized
Strength class 8.8



Artikel-Nr.	Length
6274-6-30	30 mm
6274-8-20	20 mm
6274-6-20	20 mm
6274-12-40	40 mm
6274-8-40	40 mm
6274-5-16	16 mm
6274-6-16	16 mm
6274-6-10	10 mm
6274-6-25	25 mm

02

Frame screw

with fine-pitch thread
quality 10.9 / steel
galvanised



Artikel-Nr.	Length
6273-014-50	50 mm
6273-014-40	40 mm
6273-012-50	50 mm
6273-016-50	50 mm
6273-014-60	60 mm
6273-014-30	30 mm
6273-012-30	30 mm
6273-016-40	40 mm
6273-012-40	40 mm

03

Hexagon socket screw

Flat cheese head
quality 8.8
DIN 912 / ISO 4762
galvanised



Artikel-Nr.	Length
6084-10-50	50 mm
6084-5-12	12 mm
6084-8-20	20 mm
6084-8-40	40 mm
6084-6-10	10 mm
6084-5-30	30 mm
6084-6-60	60 mm
6084-10-30	30 mm
6084-8-45	45 mm
6084-8-30	30 mm
6084-6-25	25 mm
6084-12-30	30 mm
6084-4-16	16 mm
6084-6-16	16 mm
6084-8-16	16 mm
6084-10-60	60 mm
6084-12-50	50 mm
6084-8-12	12 mm
6084-6-35	35 mm
6084-6-50	50 mm
6084-8-60	60 mm
6084-5-20	20 mm
6084-6-40	40 mm
6084-8-50	50 mm
6084-5-25	25 mm
6084-5-40	40 mm
6084-12-40	40 mm
6084-5-16	16 mm
6084-6-20	20 mm
6084-6-30	30 mm
6084-5-10	10 mm
6084-10-40	40 mm
6084-8-35	35 mm
6084-8-25	25 mm
6084-10-80	80 mm

Features of hexagon socket screw:

M4 and M5 up to length 25 mm, only without shaft
M4 and M5 from length 30 mm, only with shaft
M6 to length 30 mm, only without shaft
M6 from length 35 mm, only with shaft
M8 to length 35 mm, only without shaft

M8 from length 40 mm, only with shaft
M10 to length 40 mm, only without shaft
M10 from length 45 mm, only with shaft
M12 to length 50 mm, only without shaft
M12 from length 55 mm, only with shaft

01
Hexagon bolts A2
 DIN 933
 thread up to the head

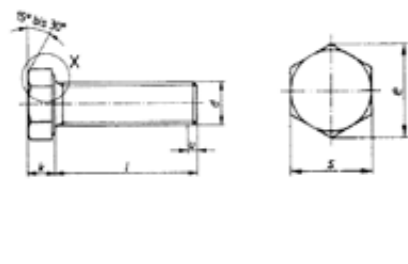

Artikel-Nr.	Length
6096-10-40	40 mm
6096-6-16	16 mm
6096-6-20	20 mm
6096-8-40	40 mm
6096-8-30	30 mm
6096-6-30	30 mm
6096-8-25	25 mm
6096-8-20	20 mm
6096-10-80	80 mm

02
Flat head bolts A2
 DIN 965
 EN ISO 7046
 with Phillips crosshead

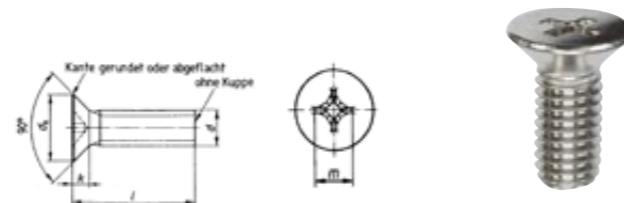

Artikel-Nr.	Length	Head Ø
6281-8-40	40 mm	14.5 mm
6281-6-20	20 mm	11 mm

05
Tapping screws with countersunk head A2
 DIN 7982
 DIN ISO 7050
 with Phillips crosshead

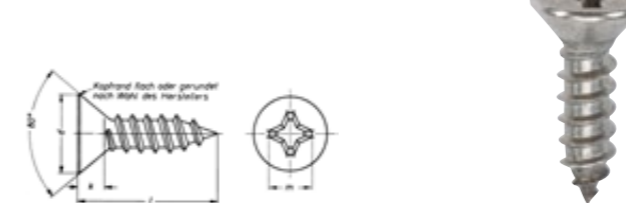

Artikel-Nr.	Length	Head Ø
6123-39-22	22 mm	7.5 mm
6123-39-16	16 mm	7.5 mm
6123-35-16	16 mm	6.8 mm
6123-35-19	19 mm	6.8 mm
6123-39-13	13 mm	7.5 mm
6123-39-95	9.5 mm	7.5 mm
6123-39-25	25 mm	7.5 mm
6123-35-13	13 mm	6.8 mm

06
Flat head chipboard screws A2
 with Pozidrive crosshead

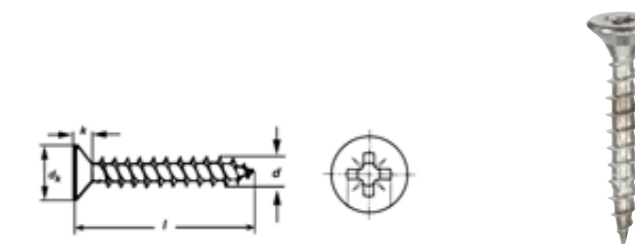

Artikel-Nr.	Length	Head Ø
6199-5-50	50 mm	9.2 mm
6199-4-45	45 mm	7.5 mm

03
Hexagon socket A2
 DIN 912 cheese head – hexagon socket

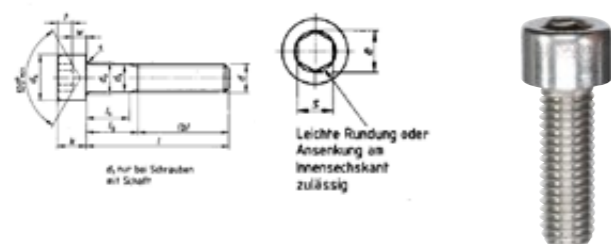

Artikel-Nr.	Length
6094-5-20	20 mm
6094-6-20	20 mm
6094-6-30	30 mm
6094-6-40	40 mm

04
Oval head sheet metal screws A2
 DIN 7981
 DIN ISO 7049
 with Phillips crosshead

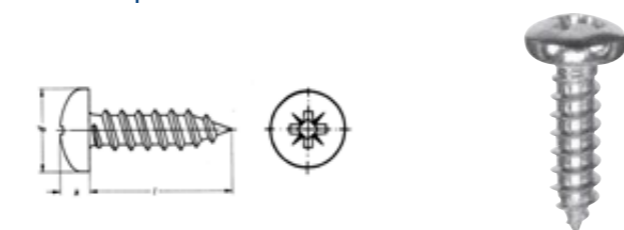

Artikel-Nr.	Length	Head Ø
6119-48-16	16 mm	8.2 mm
6119-35-16	16 mm	6.9 mm
6119-48-22	22 mm	8.2 mm
6119-42-13	13 mm	8.2 mm
6119-35-13	13 mm	6.9 mm
6119-42-25	25 mm	8.2 mm
6119-42-16	16 mm	8.2 mm
6119-48-25	25 mm	8.2 mm
6119-48-19	19 mm	8.2 mm
6119-35-95	9.5 mm	6.9 mm
6119-48-13	13 mm	8.2 mm
6119-42-19	19 mm	8.2 mm

01

Poly lock nut A2
DIN 985 / ISO 10511
Self-locking
Plastic ring

Item no.	Model
6391-5	M5
6391-6	M6
6391-8	M8
6391-10	M10
6391-12	M12

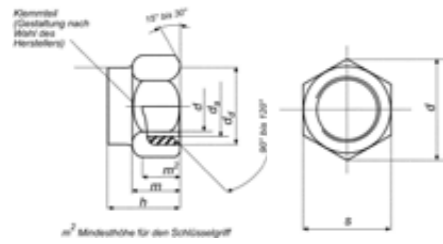

02

Hexagon nuts A2
DIN 934

Item no.	Model
6322-5	M5
6322-6	M6
6322-8	M8
6322-10	M10
6322-12	M12

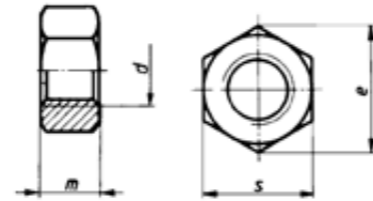

03

Plain washers A2
DIN 9021
EN ISO 7093
external diameter~3x
hole diameter

Item no.	Model
6419-5	5.3
6419-6	6.4
6419-8	8.4
6419-10	10.5

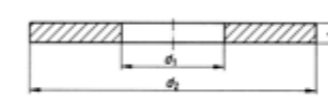

04

Washers A2
DIN 125
EN ISO 7089
type A without chamfer

Item no.	Model
6409-5	5.3
6409-6	6.4
6409-8	8.4
6409-10	10.5

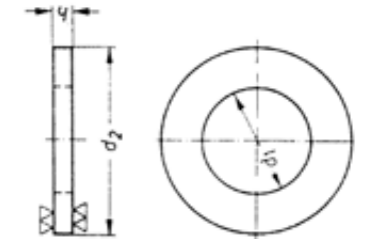

05

Hexagon cap nuts A2
DIN 1587

Item no.	Model
6348-6	M6
6348-8	M8

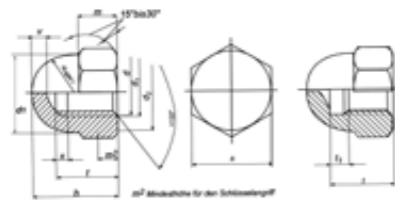

01
Poly lock nut
DIN 985
quality 8
galvanised

► Item no. 6368



01

02
Poly lock nut
DIN 985
quality 10
yellow chromated

► Item no. 6370



02

03
Self-locking nut with serrated bearing
yellow chromated Toothed

► Item no. 6394



03

04
Hexagon nut
DIN 934
quality 8 / ISO 4032
galvanised

► Item no. 6317



04

05
Hexagon nut
With loose corrugated washer Yellow chromated

► Item no. 6379



05

06
Hexagon cap nut
high shape
galvanised
DIN 1587 / FK 6

► Item no. 6356



06

07
Full metal lock nut
DIN 980
quality 10
galvanised

► Item no. 6369



07

08
Full metal lock nut
DIN 980
quality 10
yellow chromated

► Item no. 6369-0



08

09
Frame nut
Toothed DIN 6798 Grade A 10.9 Galvanised



09

Item no.	
6273-012	M12
6273-014	M14
6273-016	M16

10
Spring washer
corrugated
DIN 137 B
galvanised

► Art. no.: 6435



10

11
Serrated lock washer
With fine-pitch thread DIN 6798 Galvanised steel

► Art. no.: 6429



11

12
Washer
DIN 125 / ISO 7089
galvanised, type A

► Art. no.: 6407



12

13
Mud guard washer
galvanised

► Art. no.: 6411



13

14
Split washer
DIN 127
galvanised

► Art. no.: 6441



14

01

Linch pin
chromated yellow

Item no.	Shank \varnothing d mm	L in mm
6472-45	4,5	40
6472-6	6,0	40
6472-8	8,0	40
6472-10	10,0	40

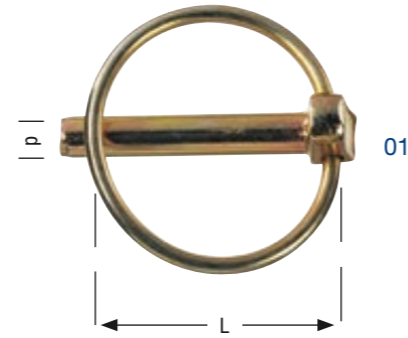

02

Spring cotter pin
Single winding, galvanized

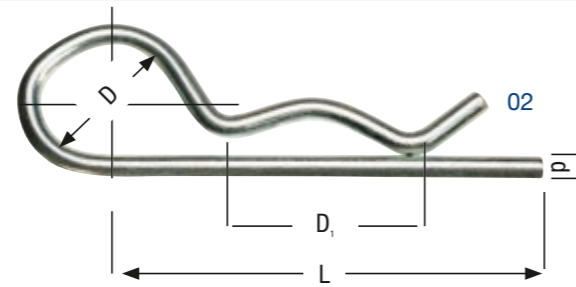

Item no.	d	Length (L)	D	Hole \varnothing	Axis o. shaft \varnothing D1
6473-2-1	2	50	10	2,5	9 - 14
6473-3-1	3	60	18	3,5	10 - 16
6473-4-1	4	60	20	4,5	16 - 20
6473-5-1	5	85	24	6,0	20 - 28
6473-6-1	6	105	30	7,0	28 - 40
6473-8-1	8	110	28	9,0	30 - 45

03

Spring cotter pin
double thread
galvanized

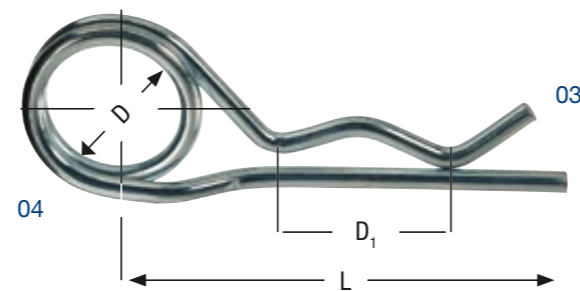

Item no.	d	Length (L)	D	Hole \varnothing	Axis o. shaft \varnothing D1
6473-2-3	2	50	10	2,5	8 - 14
6473-3-3	3	62	16	3,5	14 - 20
6473-4-3	4	78	23	4,5	17 - 24
6473-5-3	5	92	26	5,5	18 - 30
6473-6-3	6	120	30	6,5	24 - 36

04

Cotter bolts
DIN 1434
quality 10.9
steel galvanised

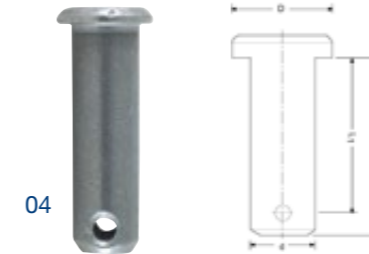

Item no.	d \varnothing mm	L1 mm	L mm	D \varnothing mm
6260-001-4				
6260-001-42				

06

Clamping sleeves
DIN 1481blank



Item no.	Model
6476-2-20	2 x 20
6476-2-30	2 x 30
6476-3-20	3 x 20
6476-3-40	3 x 40
6476-4-40	4 x 40
6476-4-60	4 x 60
6476-5-30	5 x 30
6476-5-40	5 x 40
6476-5-60	5 x 60
6476-6-40	6 x 40
6476-6-50	6 x 50
6476-6-60	6 x 60
6476-8-40	8 x 40
6476-8-50	8 x 50
6476-8-60	8 x 60
6476-10-60	10 x 60

05

Threaded rods
DIN 975, 1 metre
quality 8.8
galvanised

Item no.	Thread
6958-5	M5
6958-6	M6
6958-8	M8
6958-10	M10
6958-12	M12



07

Steel split pin
DIN 94 / ISO 1234
galvanised

► Art. no.: 6470

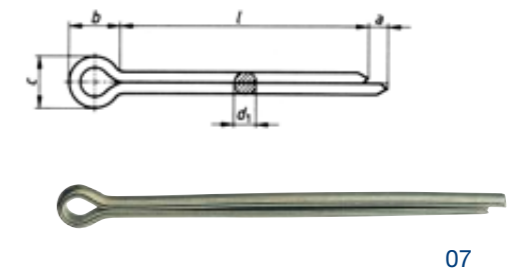

01

Assortment of oval head sheet metal screws

With Phillips recessed head (shape H), DIN 7981 / ISO 7046 Galvanised, strength class 4.8

► Item no. 1957-115

Contents: 1,600

100 x 3.5 x 13	(art. no. 6115-35-13)
100 x 3.5 x 16	(art. no. 6115-35-16)
100 x 3.5 x 19	(art. no. 6115-35-19)
100 x 3.5 x 9.5	(art. no. 6115-35-95)
100 x 3.9 x 19	(art. no. 6115-39-19)
100 x 4.2 x 13	(art. no. 6115-42-13)
100 x 4.2 x 16	(art. no. 6115-42-16)
100 x 4.2 x 19	(art. no. 6115-42-19)
100 x 4.2 x 22	(art. no. 6115-42-22)
100 x 4.2 x 25	(art. no. 6115-42-25)
100 x 4.2 x 9.5	(art. no. 6115-42-95)
100 x 4.8 x 13	(art. no. 6115-48-13)
100 x 4.8 x 16	(art. no. 6115-48-16)
100 x 4.8 x 19	(art. no. 6115-48-19)
100 x 4.8 x 22	(art. no. 6115-48-22)
100 x 4.8 x 25	(art. no. 6115-48-25)



01

02

Sheet metal screws range

with Phillips cross-head (shape H) with collar and tip, similar to DIN 7981, black galvanised

► Item no. 1957-134-0

Contents: 1,400 parts

100 x 3.9 X 9.5	(art. no. 6134-039-95)
100 x 3.9 X 13	(art. no. 6134-039-13)
100 x 3.9 X 16	(art. no. 6134-039-16)
100 x 3.9 X 19	(art. no. 6134-039-19)
50 x 3.9 X 22	(art. no. 6134-039-22)
50 x 3.9 X 25	(art. no. 6134-039-25)
100 x 4.2 X 9.5	(art. no. 6134-042-95)
100 x 4.2 X 13	(art. no. 6134-042-13)
100 x 4.2 X 16	(art. no. 6134-042-16)
100 x 4.2 X 19	(art. no. 6134-042-19)
50 x 4.2 X 22	(art. no. 6134-039-13)
50 x 4.2 X 25	(art. no. 6134-042-22)
100 x 4.8 X 9.5	(art. no. 6134-048-95)
100 x 4.8 X 13	(art. no. 6134-048-13)
50 x 4.8 X 16	(art. no. 6134-039-13)
50 x 4.8 X 19	(art. no. 6134-048-16)
50 x 4.8 X 22	(art. no. 6134-048-22)
50 x 4.8 X 25	(art. no. 6134-048-25)



02

03

Oval sheet metal screws range

with Phillips cross-head (shape H) with collar and drill tip, DIN 7981 / ISO 7049, black galvanised

► Item no. 1957-135-0

Contents: 1,103 pieces

200 x 4.2 X 13	(art. no. 6135-042-13)
200 x 4.2 X 16	(art. no. 6135-042-16)
200 x 4.2 X 19	(art. no. 6135-042-19)
100 x 4.2 X 25	(art. no. 6135-042-25)
200 x 4.8 X 16	(art. no. 6135-048-16)
100 x 4.8 X 22	(art. no. 6135-048-22)
100 x 4.8 X 35	(art. no. 6135-048-35)
3 x HAZET cross-head screwdriver bits 2215-PH2A	(art. no. 6135-221-5)



03

04

Oval sheet metal screws range

with Phillips cross-head (shape H), DIN 7981 / ISO 7049, black galvanised

► Item no. 1957-134

Contents: 1,650 parts

100 x 3.5X13	(art. no. 6134-35-13)
100 x 3.5X16	(art. no. 6134-35-16)
100 x 3.5X19	(art. no. 6134-35-19)
100 x 3.5X9,5	(art. no. 6134-35-95)
100 x 3.9X13	(art. no. 6134-39-13)
100 x 3.9X16	(art. no. 6134-39-16)
100 x 3.9X19	(art. no. 6134-39-19)
100 x 4.2X13	(art. no. 6134-42-13)
100 x 4.2X16	(art. no. 6134-42-16)
100 x 4.2X19	(art. no. 6134-42-19)
100 x 4.2X25	(art. no. 6134-42-25)
100 x 4.2X9,5	(art. no. 6134-42-95)
100 x 4.8X13	(art. no. 6134-48-13)
100 x 4.8X16	(art. no. 6134-48-16)
100 x 4.8X19	(art. no. 6134-48-19)
100 x 5.5X16	(art. no. 6134-55-16)
50 x 5.5X19	(art. no. 6134-55-19)
50 x 5.5X25	(art. no. 6134-55-25)



04

01

Hex sheet metal screws range

with washers and sheet nuts

► Item no. 1957-129-1

Contents: 800 parts

200 x Sheet metal nuts 4.8 (art. no. 5500-113-65)

150 x Sheet metal nuts 6.5 (art. no. 5500-113-69)

100 x Sheet metal nuts 5.6 (art. no. 5500-115-77)

100 x Hex sheet metal screws 4.8 x 16 (art. no. 6129-48-16)

50 x Hex sheet metal screws 4.8 x 19 (art. no. 6129-48-19)

50 x Hex sheet metal screws 5.5 x 16 (art. no. 6129-55-16)

50 x Hex sheet metal screws 6.5 x 16 (art. no. 6129-65-16)

100 x Hex sheet metal screws 6.5 x 20 (art. no. 6129-65-20)



01

02

Mudguard washer range

Tolerance as per DIN 522 C, galvanised

► Item no. 1957-411

Contents: 1,200 parts

100 x 4.3 X 12 X 1.25 (art. no. 6411-4-12)

100 x 4.3 X 20 X 1.25 (art. no. 6411-4-20)

100 x 5.3 X 15 X 1.25 (art. no. 6411-5-15)

100 x 5.3 X 20 X 1.25 (art. no. 6411-5-20)

100 x 6.4 X 15 X 1.5 (art. no. 6411-6-15)

100 x 6.4 X 18 X 1.5 (art. no. 6411-6-18)

100 x 6.4 X 20 X 1.25 (art. no. 6411-6-20)

50 x 6.4 X 30 X 1.25 (art. no. 6411-6-30)

100 x 6.5 X 25 X 1.25 (art. no. 6411-6-25)

50 x 6.5 X 40 X 1.5 (art. no. 6411-6-40)

100 x 8.4 X 25 X 1.5 (art. no. 6411-8-25)

50 x 8.4 X 30 X 1.5 (art. no. 6411-8-30)

100 x 8.5 X 20 X 1.25 (art. no. 6411-8-20)

50 x 10.5 X 30 X 1.5 (art. no. 6411-10-30)

30 x 10.5 X 40 X 2 (art. no. 6411-10-40)

50 x 13.0 X 32 X 1.5 (art. no. 6411-12-30)



02

03

Steel splint range

DIN 94 / ISO 1234, galvanised

► Item no. 1957-470

Contents: 1,100 pieces

100 x 1,6 x 32 (art. no. 6470-16-32)

100 x 2 x 22 (art. no. 6470-2-22)

100 x 2 x 32 (art. no. 6470-2-32)

100 x 2 x 40 (art. no. 6470-2-40)

100 x 3,2 x 20 (art. no. 6470-32-20)

100 x 3,2 x 32 (art. no. 6470-32-32)

100 x 3,2 x 40 (art. no. 6470-32-40)

100 x 4 x 32 (art. no. 6470-4-32)

100 x 4 x 40 (art. no. 6470-4-40)

100 x 4 x 50 (art. no. 6470-4-50)

50 x 5 x 40 (art. no. 6470-5-40)

50 x 5 x 50 (art. no. 6470-5-50)



03

04

Assortment tower without parts

► Item no. 1958-100

► Product description

- Stackable
- For wall attachment
- Lockable
- 5 drawers
- HxWxD= 360mm x 390mm x 256mm



04

01

Copper sealing ring assortment DIN 7603A

► Item no. 1957-460

Contents: 1,190 parts

100 x 6 x 10 x 1 (Art. No. 6460-6-10)
100 x 8 x 12 x 1 (art. no. 6460-8-12)
100 x 8 x 14 x 1 (Art. No. 6460-8-14)
100 x 10 x 14 x 1 (Art. No. 6460-10-14)
100 x 10 x 16 x 1 (Art. No. 6460-10-16)
100 x 12 x 16 x 1.5 (Art. No. 6460-12-16)
100 x 12 x 18 x 1.5 (Art. No. 6460-12-18)
50 x 14 x 18 x 1.5 (Art. No. 6460-14-18)
50 x 14 x 20 x 1.5 (Art. No. 6460-14-20)
50 x 14 x 22 x 1.5 (Art. No. 6460-14-22)
50 x 16 x 22 x 1.5 (Art. No. 6460-16-22)
50 x 18 x 24 x 1.5 (Art. No. 6460-18-24)
50 x 20 x 26 x 1.5 (Art. No. 6460-20-26)
50 x 22 x 27 x 1.5 (Art. No. 6460-22-27)
50 x 22 x 29 x 1.5 (Art. No. 6460-22-29)
30 x 24 x 30 x 2 (Art. No. 6460-24-30)
30 x 26 x 32 x 2 (Art. No. 6460-26-32)
30 x 28 x 34 x 2 (Art. No. 6460-28-34)



01

02

Assortment of gaskets for oil-drain plugs

► Item no. 1957-462

Contents: 1,000 parts

100 x Copper sealing ring shape A 12 x 18 x 1.5 (art. no. 6460-12-18)
100 x Copper sealing ring shape A 14 x 20 x 1.5 (art. no. 6460-14-20)
100 x Copper sealing ring shape C 14 x 21 x 2 (art. no. 6462-14-21)
100 x Copper sealing ring shape C 16 x 22 x 2 (art. no. 6462-16-22)
100 x Copper sealing ring shape C 18 x 24 x 2 (art. no. 6462-18-24)
100 x Aluminium sealing ring shape A 12 x 17 x 1,5 (art. no. 6463-12-18)
50 x Toyota sealing ring NF231 12 x 24 x 2 (art. no. 6464-012-242)
50 x Nissan folding ring 11 x 17 x 3 (art. no. 6464-11-17)
50 x Ford gasket NBR 70 12.8 x 22.5 x 3 (art. no. 6464-128-225)
100 x Plastic sealing ring PA6 14.5 x 22 x 2 (art. no. 6464-14-22)
50 x Ford sealing ring 16.7 x 24 x 2 large lip (art. no. 6464-16-24)
100 x Opel NBR 70 sealing ring 18 x 22 x 2 (art. no. 6464-18-2)



02

03

Perbunan O-ring assortment

► Item no. 1957-468-1

Contents: 1,050 parts

100 x 3.00 x 2.00 (art. no. 6468-003-20)
100 x 4.00 x 2.00 (art. no. 6468-004-20)
100 x 5.00 x 2.00 (art. no. 6468-005-20)
100 x 6.00 x 2.00 (art. no. 6468-006-20)
100 x 7.00 x 2.00 (art. no. 6468-007-20)
100 x 8.00 x 2.00 (art. no. 6468-008-20)
50 x 10.00 x 2.00 (art. no. 6468-010-20)
50 x 10.00 x 2.50 (art. no. 6468-010-25)
50 x 12.00 x 2.00 (art. no. 6468-012-20)
50 x 12.00 x 2.50 (art. no. 6468-012-25)
50 x 14.00 x 2.50 (art. no. 6468-014-25)
50 x 15.00 x 2.50 (art. no. 6468-015-25)
25 x 17.00 x 2.50 (art. no. 6468-017-25)
25 x 18.00 x 3.00 (art. no. 6468-018-30)
25 x 19.00 x 2.50 (art. no. 6468-019-25)
25 x 20.00 x 3.00 (art. no. 6468-020-30)
25 x 22.00 x 3.00 (art. no. 6468-022-30)
25 x 24.00 x 3.00 (art. no. 6468-024-30)



03

04

Assortment of clips and clamps

► Item no. 1957-550

Contents: 500 parts

50 x 5501-103-015 black plastic expanding rivet for 8mm drill hole
50 x 5500-940-5 fir tree clip Ford black plastic
50 x 5500-127-10 black plastic expanding rivet OPEL/AUDI/VW
50 x 5500-879-32 black plastic expanding rivet
50 x 5500-500-08 upholstery clamp
50 x 5500-201-404 black plastic expanding rivet
50 x 5500-000-000 retaining clamp V.A.G / FO



04

01

Assortment of blind rivets

DIN 7337, rivet body: Aluminium alloy, rivet mandrel: galvanised steel

► Item no. 1957-937-1

Contents: 800 parts

100 x 3x6	(art. no. 5937-3-6)
100 x 3x8	(art. no. 5937-3-8)
100 x 4x10	(art. no. 5937-4-10)
100 x 4x12	(art. no. 5937-4-12)
100 x 4x6	(art. no. 5937-4-6)
100 x 4x8	(art. no. 5937-4-8)
100 x 3x10	(art. no. 5937-3-10)
100 x 4x16	(art. no. 5937-4-16)



01

02

Blind rivet nut assortment

Aluminium

► Item no. 1957-948

Contents: 600 parts

100 x M4x6 Alu	(art. no. 5948-14-20)
100 x M5x7 Alu	(art. no. 5948-15-30)
50 x M6x9 Alu	(art. no. 5948-16-30)
50 x M8x11 Alu	(art. no. 5948-18-30)
100 x M4x6 Steel	(art. no. 5949-4-115)
100 x M5x7 Steel	(art. no. 5949-5-12)
50 x M6x9 Steel	(art. no. 5949-6-145)
50 x M8x11 Steel	(art. no. 5949-8-185)



02

03

Stratus HSS-O twist drill bit assortment

Profile ground and right-hand cut, DIN 384

► Item no. 1957-627-1

Contents: 120 parts

5 x 1.0 mm	(art. no. 4627-10)
5 x 1.5 mm	(art. no. 4627-15)
5 x 2.0 mm	(art. no. 4627-20)
5 x 2.5 mm	(art. no. 4627-25)
3 x 3.0 mm	(art. no. 4627-30)
3 x 3.5 mm	(art. no. 4627-35)
3 x 4.0 mm	(art. no. 4627-40)
3 x 4.5 mm	(art. no. 4627-45)
3 x 5.0 mm	(art. no. 4627-50)
3 x 5.5 mm	(art. no. 4627-55)
3 x 6.0 mm	(art. no. 4627-60)
3 x 6.5 mm	(art. no. 4627-65)
3 x 7.0 mm	(art. no. 4627-70)
3 x 7.5 mm	(art. no. 4627-75)
3 x 8.0 mm	(art. no. 4627-80)
3 x 8.5 mm	(art. no. 4627-85)
3 x 9.0 mm	(art. no. 4627-90)
3 x 9.5 mm	(art. no. 4627-95)
3 x 10.0 mm	(art. no. 4627-100)
3 x 10.5 mm	(art. no. 4627-105)



03

04

Night Line HSS twist drill bit assortment

Basic assortment

► Item no. 1957-626

Contents: 120 Teile

5 x 10.5mm	(art. no. 4626-105)
5 x 10.0mm	(art. no. 4626-100)
5 x 9.5mm	(art. no. 4626-95)
5 x 9.0mm	(art. no. 4626-90)
5 x 8.5mm	(art. no. 4626-85)
5 x 8.0mm	(art. no. 4626-80)
5 x 7.5mm	(art. no. 4626-75)
5 x 7.0mm	(art. no. 4626-70)
5 x 6.5mm	(art. no. 4626-65)
5 x 6.0mm	(art. no. 4626-60)
5 x 5.5mm	(art. no. 4626-55)
5 x 5.0mm	(art. no. 4626-50)
5 x 4.5mm	(art. no. 4626-45)
5 x 4.0mm	(art. no. 4626-40)
5 x 3.5mm	(art. no. 4626-35)
5 x 3.0mm	(art. no. 4626-30)
10 x 2.5mm	(art. no. 4626-25)
10 x 2.0mm	(art. no. 4626-20)
10 x 1.5mm	(art. no. 4626-15)
10 x 1.0mm	(art. no. 4626-10)



04

01

Assortment of universal O-rings

► Item no. 1957-500-1

Contents: 360 parts

20 x 4.47 x 1.78	(art. no. 5000-003)
20 x 6.02 x 2.62	(art. no. 5000-032)
20 x 6.07 x 1.78	(art. no. 5000-007)
20 x 6.70 x 1.70	(art. no. 5000-067)
20 x 6.95 x 2.20	(art. no. 5000-070)
20 x 7.50 x 2.50	(art. no. 5000-068)
20 x 7.65 x 1.63	(art. no. 5000-012)
20 x 7.65 x 1.78	(art. no. 5000-050)
20 x 7.00 x 1.50	(art. no. 5000-069)
20 x 8.00 x 1.80	(art. no. 5000-071)
20 x 8.00 x 2.00	(art. no. 5000-004)
20 x 8.80 x 1.90	(art. no. 5000-072)
20 x 9.25 x 1.78	(art. no. 5000-016)
20 x 9.25 x 2.39	(art. no. 5000-005)
20 x 9.50 x 2.50	(art. no. 5000-060)
20 x 10.12 x 1.85	(art. no. 5000-010)
20 x 10.00 x 2.00	(art. no. 5000-073)
20 x 10.00 x 2.50	(art. no. 5000-008)



01

02

Assortment of universal O-rings

► Item no. 1957-500-2

Contents: 360 parts

20 x 10.77 X 2.62	(art. no. 5000-034)
20 x 10.80 X 2.40	(art. no. 5000-009)
20 x 10.80 X 2.40	(art. no. 5000-061)
20 x 10.82 X 1.78	(art. no. 5000-017)
20 x 11.50 X 2.50	(art. no. 5000-062)
20 x 12.01 X 1.88	(art. no. 5000-047)
20 x 12.37 X 2.62	(art. no. 5000-035)
20 x 13.40 X 1.78	(art. no. 5000-063)
20 x 13.80 X 2.40	(art. no. 5000-064)
20 x 13.94 X 2.62	(art. no. 5000-036)
20 x 14.00 X 1.78	(art. no. 5000-023)
20 x 14.25 X 2.40	(art. no. 5000-065)
20 x 14.30 X 2.30	(art. no. 5000-021)
20 x 14.50 X 2.50	(art. no. 5000-066)
20 x 15.47 X 3.53	(art. no. 5000-043)
20 x 15.68 X 1.93	(art. no. 5000-026)
20 x 17.17 X 1.78	(art. no. 5000-028)
20 x 17.00 X 2.00	(art. no. 5000-029)



02

03

Assortment of universal valves

► Item no. 1957-500-4

Contents: 51 parts

20 x Standard valve insert	(art. no. 5000-106)
1 x Small valve tool	(art. no. 5000-121)
5 x M8 PEUGEOT / VOLVO valve	(art. no. 5000-122)
5 x EATON 8 mm valve	(art. no. 5000-123)
5 x EATON 10 mm valve	(art. no. 5000-124)
5 x JRA HNBR valve	(art. no. 5000-125)
5 x RENAULT valve	(art. no. 5000-126)
5 x AUDI valve	(art. no. 5000-127)



03

04

Assortment of heat shrink tubing

► Item no. 1957-570

Length per piece: 10 cm

Shrinkage ratio 2:1

Contents: 125 parts

25 x 2.4mm/ 1.2mm	(art. no. 3771-200-24)
25 x 3.2mm/ 1.6mm	(art. no. 3771-200-32)
25 x 4.8mm/ 2.4mm	(art. no. 3771-200-48)
10 x 6.4mm/ 3.2mm	(art. no. 3771-200-64)
10 x 9.5mm/ 4.7mm	(art. no. 3771-200-95)
10 x 12.7mm/ 6.4mm	(art. no. 3771-200-127)
10 x 19.0mm/ 9.5mm	(art. no. 3771-200-190)
10 x 25.4mm/12.7mm	(art. no. 3771-200-254)



04

05

Assortment of button cells

► Item no. 1957-580

Contents: 75 parts

10 x CR1220 3V	(art. no. 3722-27)
10 x CR1616 3V	(art. no. 3722-26)
10 x CR1620 3V	(art. no. 3722-25)
10 x CR1632 3V	(art. no. 3722-30)
10 x CR2016 3V	(art. no. 3722-23)
10 x CR2025 3V	(art. no. 3722-20)
10 x CR2032 3V	(art. no. 3722-21)
5 x LR1 1.5V (4001)	(art. no. 3722-29)



05

01

Assortment of cable connectors

waterproof

► Item no. 1957-555

Contents: 400 parts

50 x Heat-shrink connectors red 0.5-1.5 (art. no. 3555-516-1)

50 x Heat-shrink connectors blue 1.5-2.5 (art. no. 3555-516-2)

25 x Heat-shrink connectors yellow 4.0-6.0 (art. no. 3555-516-4)

25 x Ring tongues M6 red with shrink hose (art. no. 3555-903-1)

25 x Ring tongues M8 red with shrink hose (art. no. 3555-904-1)

25 x Ring tongues M5 blue with shrink hose (art. no. 3555-909-2)

25 x Ring tongues M8 blue with shrink hose (art. no. 3555-911-2)

50 x Butt connector solderable red 0.5-1.5 (art. no. 3555-923-1)

50 x Butt connector solderable blue 1.5-2.5 (art. no. 3555-923-2)

25 x Butt connector solderable yellow 3.0-6.0 (art. no. 3555-923-3)

25 x Push-on male connector blue with shrink hose (art. no. 3555-945-2)

25 x Push-on female connector blue with shrink hose (art. no. 3555-905-2)



01

02

Assortment of cable connectors

Insulated

► Item no. 1957-558-1

Contents: 530 parts

20 x Cable quick connector blue (art. no. 3555-564)

25 x Ring tongue M4 red (art. no. 3558-901-1)

50 x Push-on female connector red (art. no. 3558-905-1)

100 x Push-on female connector blue (art. no. 3558-905-2)

50 x Push-on female connector yellow (art. no. 3558-905-4)

25 x Ring tongue M4 blue (art. no. 3558-908-2)

25 x Ring tongue M5 blue (art. no. 3558-909-2)

25 x Ring tongue M6 blue (art. no. 3558-910-2)

25 x Ring tongue M6 yellow (art. no. 3558-916-4)

25 x Butt connector red (art. no. 3558-925-1)

25 x Butt connector blue (art. no. 3558-926-2)

25 x Double plug connector blue (art. no. 3558-943-2)

25 x Push-on male connector 6.3mm red (art. no. 3558-944-1)

25 x Push-on male connector 6.3mm blue (art. no. 3558-945-2)

15 x Round male connector red (art. no. 3558-946-1)

15 x Round female connector red (art. no. 3558-947-1)

15 x Round male connector blue (art. no. 3558-948-2)

15 x Round female connector blue (art. no. 3558-949-2)



02

03

Assortment of blade fuses

Mini and low-profile fuses

► Item no. 1957-730-2

Contents: 280 parts

25 x Plug fuse 3A MINI (art. no. 3731-103)

25 x Plug fuse 5A MINI (art. no. 3731-105)

25 x Plug fuse 7.5A MINI (art. no. 3731-107-5)

25 x Plug fuse 10A MINI (art. no. 3731-110)

25 x Plug fuse 15A MINI (art. no. 3731-115)

25 x Plug fuse 20A MINI (art. no. 3731-120)

25 x Plug fuse 25A MINI (art. no. 3731-125)

25 x Plug fuse 30A MINI (art. no. 3731-130)

25 x Plug fuse 3A / LOW-PROFILE (art. no. 3731-303)

25 x Plug fuse 5A / LOW-PROFILE (art. no. 3731-305)

25 x Plug fuse 7,5A / LOW-PROFILE (art. no. 3731-307-5)

25 x Plug fuse 10A / LOW-PROFILE (art. no. 3731-310)

25 x Plug fuse 15A / LOW-PROFILE (art. no. 3731-315)

25 x Plug fuse 20A / LOW-PROFILE (art. no. 3731-320)

25 x Plug fuse 25A / LOW-PROFILE (art. no. 3731-325)

25 x Plug fuse 30A / LOW-PROFILE (art. no. 3731-330)



03

04

Assortment of blade fuses

► Item no. 1957-730-1

Contents: 161 parts

10 x 3A (art. no. 3731-003)

10 x 5A (art. no. 3731-005)

10 x 7.5A (art. no. 3731-007-5)

10 x 10A (art. no. 3731-010)

10 x 15A (art. no. 3731-015)

10 x 20A (art. no. 3731-020)

10 x 25A (art. no. 3731-025)

10 x 30A (art. no. 3731-030)

10 x 3A MINI (art. no. 3731-103)

10 x 5A MINI (art. no. 3731-105)

10 x 7.5A MINI (art. no. 3731-107-5)

10 x 10A MINI (art. no. 3731-110)

10 x 15A MINI (art. no. 3731-115)

10 x 20A MINI (art. no. 3731-120)

10 x 25A MINI (art. no. 3731-125)

10 x 30A MINI (art. no. 3731-130)

1 x Tester and gripper kit (art. no. 3731-150)



04

01

Waterproof rack assortment

► Item no. 1957-560

4 x Lock casing with gasket 2-fold (art. no. 3558-82)
 4 x Lock casing with gasket 3-fold (art. no. 3558-83)
 4 x Lock casing with gasket 4-fold (art. no. 3558-84)
 4 x Lock casing with gasket 5-fold (art. no. 3558-85)
 4 x Lock casing with gasket 6-fold (art. no. 3558-86)

4 x Mount casing 2-fold (art. no. 3558-82-1)
 4 x Mount casing 3-fold (art. no. 3558-83-1)
 4 x Mount casing 4-fold (art. no. 3558-84-1)
 4 x Mount casing 5-fold (art. no. 3558-85-1)
 4 x Mount casing 6-fold (art. no. 3558-86-1)

100 x push-on female connector 0.75 - 1.5 (art. no. 3558-87-2)
 100 x push-on female connector 0.75 - 1.5 (art. no. 3558-87-21)
 100 x sealing stopper yellow 0.75 - 1.5 (art. no. 3558-88-2)
 100 x sealing stopper red 1.5 - 2.5 (art. no. 3558-88-3)



01

02

Assortment of clamping sleeves

DIN 1481, blank

► Item no. 1957-476

Contents: 985 parts

100 x 2 X 20 (art. no. 6476-2-20)
 100 x 2 X 30 (art. no. 6476-2-30)
 100 x 3 X 20 (art. no. 6476-3-20)
 100 x 3 X 40 (art. no. 6476-3-40)
 100 x 4 X 40 (art. no. 6476-4-40)
 100 x 4 X 60 (art. no. 6476-4-60)
 50 x 5 X 30 (art. no. 6476-5-30)
 50 x 5 X 40 (art. no. 6476-5-40)
 50 x 5 X 60 (art. no. 6476-5-60)
 50 x 6 X 40 (art. no. 6476-6-40)
 50 x 6 X 50 (art. no. 6476-6-50)
 50 x 6 X 60 (art. no. 6476-6-60)
 25 x 8 X 40 (art. no. 6476-8-40)
 25 x 8 X 50 (art. no. 6476-8-50)
 25 x 8 X 60 (art. no. 6476-8-60)
 10 x 10 X 60 (art. no. 6476-10-60)



02

03

Assortment of screwed connections

► Item no. 1957-54-016

Inhalt: 123 Teile

10 x Cutting ring 6 (art. no. 1002-54-062)
 10 x Cutting ring 8 (art. no. 1002-54-082)
 8 x Cutting ring 10 (art. no. 1002-54-102)
 8 x Cutting ring 12 (art. no. 1002-54-122)
 5 x Cutting ring 15 (art. no. 1002-54-152)
 10 x Union nut 6 (art. no. 1002-54-063)
 10 x Union nut 8 (art. no. 1002-54-083)
 8 x Union nut 10 (art. no. 1002-54-103)
 8 x Union nut 12 (art. no. 1002-54-123)
 5 x Union nut 15 (art. no. 1002-54-153)
 10 x Supporting sleeve 6 x 1 (art. no. 1002-54-061)
 10 x Supporting sleeve 8 x 1 (art. no. 1002-54-081)
 8 x Supporting sleeve 10 x 1 (art. no. 1002-54-101)
 8 x Supporting sleeve 12 x 1 (art. no. 1002-54-121)
 5 x Supporting sleeve 15 x 1.5 (art. no. 1002-54-151)



03

04

Assortment of direct connectors

Brass, plastic

► Item no. 1957-100-1

Contents: 40 parts

5 x Plastic straight connector 4mm (art. no. 1002-06-04)
 5 x Plastic straight connector 5mm (art. no. 1002-06-05)
 5 x Plastic straight connector 6mm (art. no. 1002-06-06)
 5 x Plastic straight connector 8mm (art. no. 1002-06-08)
 5 x Brass straight connector 10mm (art. no. 1002-16-010)
 5 x Brass straight connector 12mm (art. no. 1002-16-012)
 5 x Brass straight connector 6mm (art. no. 1002-16-06)
 5 x Brass straight connector 8mm (art. no. 1002-16-08)



04

01

Assortment of plastic hose connectors

► Item no. 1957-896

Contents: 160 parts

10 x Straight hose connector 3mm	(art. no. 5896-103)
10 x Straight hose connector 4mm	(art. no. 5896-104)
10 x Straight hose connector 5mm	(art. no. 5896-105)
10 x Straight hose connector 6mm	(art. no. 5896-106)
10 x T-hose connector 3mm	(art. no. 5896-203)
10 x T-hose connector 4mm	(art. no. 5896-204)
10 x T-hose connector 5mm	(art. no. 5896-205)
10 x T-hose connector 6mm	(art. no. 5896-206)
10 x Angled hose connector 3mm	(art. no. 5896-303)
10 x Angled hose connector 4mm	(art. no. 5896-304)
10 x Angled hose connector 5mm	(art. no. 5896-305)
10 x Angled hose connector 6mm	(art. no. 5896-306)
10 x Y-hose connector 3mm	(art. no. 5896-403)
10 x Y-hose connector 4mm	(art. no. 5896-404)
10 x Y-hose connector 5mm	(art. no. 5896-405)
10 x Y-hose connector 6mm	(art. no. 5896-406)



01

02

Hex sheet metal screws range

with washers and sheet nuts

► Item no. 1957-129-1

Contents: 800 parts

200 x Sheet metal nuts 4.8	(art. no. 5500-113-65)
150 x Sheet metal nuts 6.5	(art. no. 5500-113-69)
100 x Sheet metal nuts 5.6	(art. no. 5500-115-77)
100 x Hex sheet metal screws 4.8 x 16	(art. no. 6129-48-16)
50 x Hex sheet metal screws 4.8 x 19	(art. no. 6129-48-19)
50 x Hex sheet metal screws 5.5 x 16	(art. no. 6129-55-16)
50 x Hex sheet metal screws 6.5 x 16	(art. no. 6129-65-16)
100 x Hex sheet metal screws 6.5 x 20	(art. no. 6129-65-20)



02

03

Mudguard washer range

Tolerance as per DIN 522 C, galvanised

► Item no. 1957-411

Contents: 1,200 parts

100 x 4.3 X 12 X 1.25	(art. no. 6411-4-12)
100 x 4.3 X 20 X 1.25	(art. no. 6411-4-20)
100 x 5.3 X 15 X 1.25	(art. no. 6411-5-15)
100 x 5.3 X 20 X 1.25	(art. no. 6411-5-20)
100 x 6.4 X 15 X 1.5	(art. no. 6411-6-15)
100 x 6.4 X 18 X 1.5	(art. no. 6411-6-18)
100 x 6.4 X 20 X 1.25	(art. no. 6411-6-20)
50 x 6.4 X 30 X 1.25	(art. no. 6411-6-30)
100 x 6.5 X 25 X 1.25	(art. no. 6411-6-25)
50 x 6.5 X 40 X 1.5	(art. no. 6411-6-40)
100 x 8.4 X 25 X 1.5	(art. no. 6411-8-25)
50 x 8.4 X 30 X 1.5	(art. no. 6411-8-30)
100 x 8.5 X 20 X 1.25	(art. no. 6411-8-20)
50 x 10.5 X 30 X 1.5	(art. no. 6411-10-30)
30 x 10.5 X 40 X 2	(art. no. 6411-10-40)
50 x 13.0 X 32 X 1.5	(art. no. 6411-12-30)



03

01

Assortment of oval head sheet metal screws

With Phillips recessed head (shape H), DIN 7981 / ISO 7046 Galvanised, strength class 4.8

► Item no. 1957-115

Contents: 1,600

100 x 3.5 x 13	(art. no. 6115-35-13)
100 x 3.5 x 16	(art. no. 6115-35-16)
100 x 3.5 x 19	(art. no. 6115-35-19)
100 x 3.5 x 9.5	(art. no. 6115-35-95)
100 x 3.9 x 19	(art. no. 6115-39-19)
100 x 4.2 x 13	(art. no. 6115-42-13)
100 x 4.2 x 16	(art. no. 6115-42-16)
100 x 4.2 x 19	(art. no. 6115-42-19)
100 x 4.2 x 22	(art. no. 6115-42-22)
100 x 4.2 x 25	(art. no. 6115-42-25)
100 x 4.2 x 9.5	(art. no. 6115-42-95)
100 x 4.8 x 13	(art. no. 6115-48-13)
100 x 4.8 x 16	(art. no. 6115-48-16)
100 x 4.8 x 19	(art. no. 6115-48-19)
100 x 4.8 x 22	(art. no. 6115-48-22)
100 x 4.8 x 25	(art. no. 6115-48-25)



01

02

Sheet metal screws range

with Phillips cross-head (shape H) with collar and tip, similar to DIN 7981, black galvanised

► Item no. 1957-134-0

Contents: 1,400 parts

100 x 3.9 X 9.5	(art. no. 6134-039-95)
100 x 3.9 X 13	(art. no. 6134-039-13)
100 x 3.9 X 16	(art. no. 6134-039-16)
100 x 3.9 X 19	(art. no. 6134-039-19)
50 x 3.9 X 22	(art. no. 6134-039-22)
50 x 3.9 X 25	(art. no. 6134-039-25)
100 x 4.2 X 9.5	(art. no. 6134-042-95)
100 x 4.2 X 13	(art. no. 6134-042-13)
100 x 4.2 X 16	(art. no. 6134-042-16)
100 x 4.2 X 19	(art. no. 6134-042-19)
50 x 4.2 X 22	(art. no. 6134-039-13)
50 x 4.2 X 25	(art. no. 6134-042-22)
100 x 4.8 X 9.5	(art. no. 6134-048-95)
100 x 4.8 X 13	(art. no. 6134-048-13)
50 x 4.8 X 16	(art. no. 6134-039-13)
50 x 4.8 X 19	(art. no. 6134-048-16)
50 x 4.8 X 22	(art. no. 6134-048-22)
50 x 4.8 X 25	(art. no. 6134-048-25)



02

03

Oval sheet metal screws range

with Phillips cross-head (shape H) with collar and drill tip, DIN 7981 / ISO 7049, black galvanised

► Item no. 1957-135-0

Contents: 1,103 pieces

200 x 4.2 X 13	(art. no. 6135-042-13)
200 x 4.2 X 16	(art. no. 6135-042-16)
200 x 4.2 X 19	(art. no. 6135-042-19)
100 x 4.2 X 25	(art. no. 6135-042-25)
200 x 4.8 X 16	(art. no. 6135-048-16)
100 x 4.8 X 22	(art. no. 6135-048-22)
100 x 4.8 X 35	(art. no. 6135-048-35)
3 x HAZET cross-head screwdriver bits 2215-PH2A	(art. no. 6135-221-5)



03

04

Oval sheet metal screws range

with Phillips cross-head (shape H), DIN 7981 / ISO 7049, black galvanised

► Item no. 1957-134

Contents: 1,650 parts

100 x 3.5X13	(art. no. 6134-35-13)
100 x 3.5X16	(art. no. 6134-35-16)
100 x 3.5X19	(art. no. 6134-35-19)
100 x 3.5X9,5	(art. no. 6134-35-95)
100 x 3.9X13	(art. no. 6134-39-13)
100 x 3.9X16	(art. no. 6134-39-16)
100 x 3.9X19	(art. no. 6134-39-19)
100 x 4.2X13	(art. no. 6134-42-13)
100 x 4.2X16	(art. no. 6134-42-16)
100 x 4.2X19	(art. no. 6134-42-19)
100 x 4.2X25	(art. no. 6134-42-25)
100 x 4.2X9,5	(art. no. 6134-42-95)
100 x 4.8X13	(art. no. 6134-48-13)
100 x 4.8X16	(art. no. 6134-48-16)
100 x 4.8X19	(art. no. 6134-48-19)
100 x 5.5X16	(art. no. 6134-55-16)
50 x 5.5X19	(art. no. 6134-55-19)
50 x 5.5X25	(art. no. 6134-55-25)



04

01

Steel splint range

DIN 94 / ISO 1234, galvanised

► Item no. 1957-470

Contents: 1,100 pieces

100 x 1,6 x 32 (art. no. 6470-16-32)

100 x 2 x 22 (art. no. 6470-2-22)

100 x 2 x 32 (art. no. 6470-2-32)

100 x 2 x 40 (art. no. 6470-2-40)

100 x 3,2 x 20 (art. no. 6470-32-20)

100 x 3,2 x 32 (art. no. 6470-32-32)

100 x 3,2 x 40 (art. no. 6470-32-40)

100 x 4 x 32 (art. no. 6470-4-32)

100 x 4 x 40 (art. no. 6470-4-40)

100 x 4 x 50 (art. no. 6470-4-50)

50 x 5 x 40 (art. no. 6470-5-40)

50 x 5 x 50 (art. no. 6470-5-50)



01

02

Assortment box

Plastic

► Item no. 1958-001

► Product description

- H x W x D = 320 mm x 240 mm x 49 mm



02

03

Assortment tower without parts

► Item no. 1958-100

► Product description

- Stackable

- For wall attachment

- Lockable

- 5 drawers

- HxWxD= 360mm x 390mm x 256mm

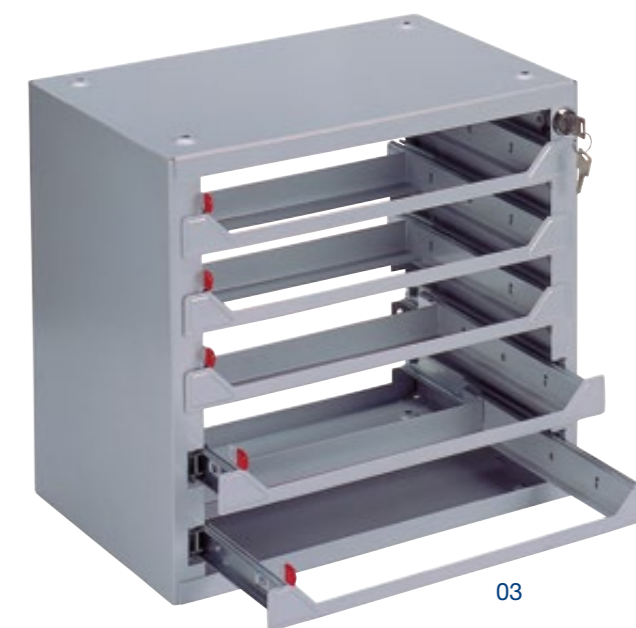

03

04

Insert 20-fold

For plastic assortment case, can be used for drill bits

► Item no. 1958-001-20

► Product description

- Width: 320 mm

- Depth: 240 mm

- Height: 49 mm



04

05

Insert

with same sized boxes

Item no.	Model
1958-001-8	8-fold
1958-001-12	12-fold
1958-001-16	16-fold
1958-001-18	18-fold



05

01

Inspection & maintenance introductory package

► Item no. 2897-001

Contents:

- 2 x VC980, throttle cleaner, 400 ml (art. no. 2897-368)
- 2 x High-Press, high-pressure adhesive grease, 400 ml (art. no. 2894-445-1)
- 2 x Off-Shore Silver, brake protection spray, 400 ml (art. no. 2894-449)
- 2 x Super Crack Ultra, ice rust remover, 400 ml (art. no. 2894-442-1)
- 2 x Terpanol Power, high-tech special cleaner, 400 ml (art. no. 2897-323)



01

02

Starter kit - lubricants

► Item no. 2894-401

Contents:

- 2 x Bio Top, lubricating grease white 400ML (art. no. 2894-446)
- 2 x COP, copper grease 400 ML (art. no. 2894-450)
- 2 x Siltron, silicone grease 400 ML (art. no. 2897-324)
- 2 x Soules Protect, interior cabin spray 300ML (art. no. 2897-449-1)



02

03

Bodywork introductory package

► Item no. 2897-003

Contents:

- 2 x 1K Multi-Connector light grey, 400 ml (art. no. 2893-900)
- 2 x Rednox, rust stop undercoat, 400 ml (art. no. 2893-888)
- 2 x Bottom Guard Recoat, underbody protection black, 500 ml (art. no. 2892-881)
- 2 x Kroma, matt black paint spray, 400 ml (art. no. 2893-884)
- 2 x Protector, interior cabin protector, 400 ml (art. no. 2892-997)



03

04

Repos starter kit - Plastic-repair adhesive

► Item no. 2700-001

Contents:

- 2 x Repos, synthetic glue, 50 ml (art. no. 2700-10)
- 2 x Repos fast, synthetic glue, 50 ml (art. no. 2700-15)
- 2 x Repos MMA, structural glue, 50 ml (art. no. 2700-20)
- 1 x Cartridge gun (art. no. 2700-70)
- 6 x Rod mixer square blue (art. no. 2700-42)



04

01

Vehicle treatment introductory package

► Item no. 2897-002

Contents:

- 3x Topas, windscreen cleaner 400 ml (art. no. 2897-310)
- 2x Polit, spray polish 400 ml (art. no. 2897-326)
- 2x Interno, interior cleaner 500 ml (art. no. 2000-05)
- 2x Velvet, upholstery cleaner 400 ml (art. no. 2897-307)
- 2x Aerofit Power, odour eliminator 400 ml (art. no. 2000-309-400)



01

02

Aquano skin protection set

► Item no. 2897-500-001

Contents:

- 1x Skin protection Aquano Protect 2 litres (art. no. 2897-500-2)
- 1x Hand cleaner Aquano Clean 2 litres (art. no. 2897-500-1)
- 1x Skincare lotion Aquano Lotion 2 litres (art. no. 2897-500-3)
- 1x Skin protection chart (art. no. 2897-500-7)
- 3x System dispensers (art. no. 2897-500-6)



02

03

Cleeno interior cleaning set

► Item no. 2000-001

Contents:

- 3 x Interno interior cleaner, 500 ml (art. no. 2000-05)
- 3 x Stries glass cleaner 500 ml (art. no. 2897-340)
- 3 x Velvet upholstery cleaner 400 ml (art. no. 2897-307)
- 6 x Blau microfibre cloth, 40 X 40 cm (art. no. 2000-640-40)



03

04

Cleeno exterior cleaning set

► Item no. 2000-002

Contents:

- 1 x All Star 5 litres (article no. 2000-312-5)
- 1 x Rimol Profi aluminium rim cleaner, 5 litres (article no. 2897-321-5)
- 2 x outlet taps for 5-litre vessel (article no. 2000-000-005)
- 1 x pressure-pump spray bottle, blue, 1 litre, for All-Star (article no. 2000-100)
- 1 x pressure-pump spray bottle, black, 1 litre, for Rimol Profi (article no. 2897-333-150)
- 1 x „Chemical“ cleaning glove, size 9 (art. no. 7797-009-9)
- 1 x „Chemical“ cleaning glove, size 10 (art. no. 7797-009-10)
- 1 x Cleeno goggles (article no. 0000-205)



04

01

Cable-tie set 1

► Item no. 3502-001

Contents: 1,800 black cable ties with plastic tongue

300 x 2.5mm x 98mm (art. no. 3502-111)

300 x 3.5mm x 140mm (art. no. 3502-121)

300 x 3.5mm x 200mm (art. no. 3502-131)

300 x 3.6mm x 290mm (art. no. 3502-135-1)

300 x 4.5mm x 178mm (art. no. 3502-141)

300 x 4.5mm x 280mm (art. no. 3502-151)



01

02

Cable-tie set 2

► Item no. 3502-002

Contents: 1,000 black cable ties with plastic tongue

300 x 4.5 x 350 (art. no. 3502-161)

300 x 7.6 x 200 (art. no. 3502-171)

300 x 7.5 x 360 (art. no. 3502-181)

100 x 7.8 x 750 (art. no. 3502-191)



02

03

12V Normlight bulb set for fitting in bulb cabinet

► Item no. 3723-001

Contents: 390 parts

40 x 10W tail light bulb (art. no. 3723-050-08)

40 x 5W glass base bulb (art. no. 3723-028-25)

40 x 1,2W glass base bulb (art. no. 3723-027-21)

30 x 5W soffit bulb 11x35MM (art. no. 3723-064-18)

50 x 21W indicator or brake light (art. no. 3723-075-06)

50 x 21/5W brake or tail light (art. no. 3723-075-28)

40 x 21W yellow display bulb (art. no. 3723-075-07)

10 x H4 car bulb 60/55W (art. no. 3723-064-193)

50 x 5W tail light bulb (art. no. 3723-050-07)

20 x H7 car bulb 55W (art. no. 3723-064-201)

20 x H7 Long Life car bulb (art. no. 3723-064-209)



03

NORM LIGHT

04

24V Normlight bulb set for fitting in bulb cabinet

► Item no. 3723-002

Contents: 360 parts

40 x 5W glass base bulb (art. no. 3723-028-45)

10 x H3 truck bulb 70W (art. no. 3723-064-151)

20 x H1 truck bulb 70W (art. no. 3723-064-155)

10 x H4 HD truck bulb 75/70W (art. no. 3723-064-197)

20 x H7 truck bulb 70W (art. no. 3723-064-211)

20 x H7 truck bulb HD LONGLIFE (art. no. 3720-064-273)

50 x 21/5W brake or tail light (art. no. 3723-075-37)

50 x 4W sidelight bulb HD (art. no. 3723-393-0)

40 x 5W tail light bulb HD (art. no. 3723-562-7)

50 x 10W tail light bulb HD (art. no. 3723-563-7)

50 x 21W indicator bulb HD (art. no. 3723-751-1)

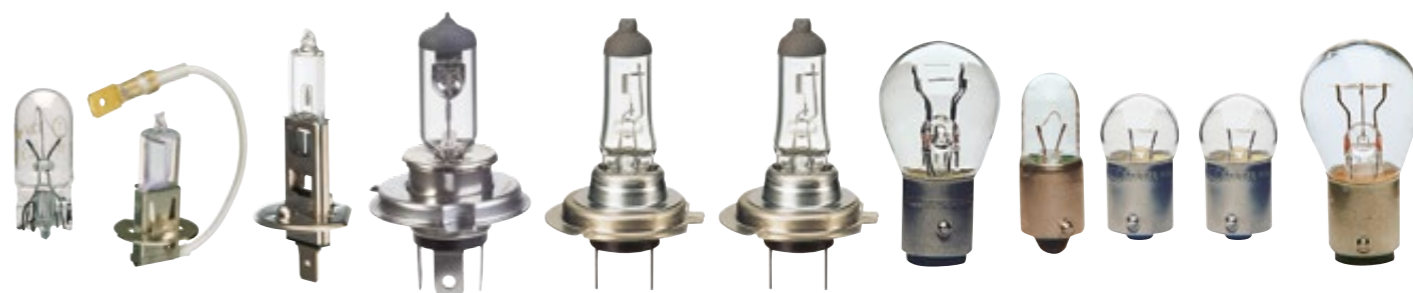

04

NORM LIGHT

Chemical products



01

Adhesive grease

High-Press Ultra

- ▶ Item no. 2894-445-3
- ▶ Contents: 400 ml
- ▶ Packing unit: 12

▶ **Product description**

- Lubricates all moving machine components, e.g. hinges, check straps, chains, gear wheels, wire ropes, slide rails, etc.
- Excellent penetrating ability
- Outstanding adhesive property
- High pressure resistance
- Resistant to salt and hot water
- Temperature range -20°C to +140°C
- Colour: light-blue

02

High-Pressure Adhesive Lubricating Grease

High-Press Black

- ▶ Item no. 2894-445-2
- ▶ Contents: 400 ml
- ▶ Packing unit: 24

▶ **Product description**

- Suitable for use in all technical applications
- Excellent penetrating ability
- Outstanding adhesive property
- Water-repellent and protects against corrosion
- Best running characteristics at high temperatures and speeds
- Temperature range -20°C to +200°C
- Colour: black



OUR TIP FOR YOU!!!

03

High-Pressure Adhesive Lubricating Grease

High-Press

- ▶ Item no. 2894-445-1
- ▶ Contents: 400 ml
- ▶ Packing unit: 24

▶ **Product description**

- Highly water repellent
- Highly resistant to pressure
- Free from sticky polymer thickeners that trap dirt
- Silicone-free
- Outstanding adhesive property
- Excellent penetrating ability
- Temperature range -20°C to +140°C
- Colour: beige/transparent



01



02



03



01

PTFE/Ceramic oil spray

Teflux

- ▶ Item no. 2894-445-4
- ▶ Contents: 400 ml
- ▶ Packing unit: 12

- ▶ Item no. 2894-445-415
- ▶ Contents: 150 ml
- ▶ Packing unit: 12

▶ **Product description**

- Extremely creep-capable
- Water repellent and protects against corrosion
- High pressure resistance
- Lubricates and oils all moving machine parts such as gear wheels, hinges, etc.
- Excellent emergency-running properties thanks to PTFE and ceramic additives
- Silicone-free
- Colour: beige
- Fragrance: vanilla



IT MAKES EVERYTHING GO SMOOTHLY!



01

SAFETY FIRST



PROtect
DIE SANFTE CHEMIE



What exactly is a product ID using the GHS system?

GHS stands for „Globally Harmonious System of Classification and Labelling of Chemicals“ and is an ordinance of the European Union (EU). It is a globally uniform system for classifying chemicals and identifying them on packaging and on safety data sheets.

The GHS system has replaced the previous classification and identification system of the EU. It is regulated through the CLP Ordinance (Classification, Labelling and Packaging). It has had to be bindingly applied to materials since 1 December 2012. The second step of GHS implementation now affects compounds and thus all chemical and technical products. For this, GHS/CLP labelling will be legally mandatory from 1 June 2015.

This directive is primarily to protect users. Through the expanded texts of hazards and symbols, users of products should be able to better identify and assess products that are a risk to health and the environment.



01

High-pressure adhesive grease

High-Press Protect

- ▶ Item no. 2894-445-5
- ▶ Contents: 400 ml
- ▶ Packing unit: 12

▶ **Technical specifications**

- H1 approval for food use
- Extremely shear-stable and adherent
- Resistant to salt and hot water
- Free of adhesive polymer thickeners
- Silicone-free
- Excellent high-pressure and high-temperature properties
- Quick-drying
- High layer thickness
- Good creep properties
- For all vehicles parts exposed to high pressure such as: door hinges, gear wheels, motorcycle chains, wire cables

02

White grease

Bio-Top Protect

- ▶ Item no. 2894-446
- ▶ Contents: 400 ml
- ▶ Packing unit: 24

▶ **Product description**

- Water repellent
- Good lubrication properties
- Good abrasion resistance
- Penetrative
- Moisture displacing
- Universal use
- Pressure resistant
- Extremely durable
- Very good adhesion
- Thermally stable from -10°C to +150°C

03

Maintenance lubricating oil spray

Fully synthetic

Multi Protect

- ▶ Item no. 2894-445-6
- ▶ Contents: 400 ml
- ▶ Packing unit: 12

▶ **Product description**

- Oxidation-resistant
- Capable of extreme creep
- Shear-stable
- Silicone-free
- Resistant to salt and hot water
- Optimal anti-corrosion properties
- Good high-pressure and high-temperature stability
- Thermally stable from -30°C to +150°C, +200°C in short term

04

Interior installation spray

Silicone-free - Soules Protect

Soules Protect

- ▶ Item no. 2897-449-1
- ▶ Contents: 300 ml
- ▶ Packing unit: 12

▶ **Technical specifications**

- Silicone free
- Eliminates moisture
- Does not resinify and provides long-lasting UV protection
- Anti-static
- Prevents door seals freezing in winter



01



02



03



04



01
Silicone grease spray
Siltron

- ▶ Item no. 2897-324
- ▶ Contents: 400 ml
- ▶ Packing unit: 12

- ▶ **Product description**
- Creates effective water-repellent film
 - Lubricates and seals
 - Fully compatible with elastomers
 - Does not resinify and is extremely resistant to ageing
 - Insulates surfaces against creeping currents and flashovers also at high and low temperatures

02
Dry lubricant
TT - Power

- ▶ Item no. 2897-447
- ▶ Contents: 400 ml
- ▶ Packing unit: 12

- ▶ **Product description**
- Oil-free, grease-free, silicone-free
 - Invisible, hardly noticeable lubricating film
 - Prevents dust formation
 - Anti-static



01



02



03



04



05

03
Silicone Premium
Siprem

- ▶ Item no. 2897-322
- ▶ Contents: 400 ml
- ▶ Packing unit: 12

- ▶ **Product description**
- At least 18% of high-quality silicone
 - Highly water repellent
 - Leaves no marks
 - Exceptional lubricating qualities

04
Maintenance spray
ECO

- ▶ Item no. 2897-351-2
- ▶ Contents: 600 ml
- ▶ Packing unit: 12

- ▶ **Product description**
- Perfect lubrication at the most difficult-to-reach greasing points
 - Reduces friction
 - Water repellent

05
Silicone spray
ECO

- ▶ Item no. 2897-322-2
- ▶ Contents: 600 ml
- ▶ Packing unit: 12

- ▶ **Product description**
- Reduces squeaks
 - Water repellent
 - Impregnating
 - Leaves no marks

01
Injector, glow plug and spark plug igniter
Inject-Crack

- ▶ Item no. 2894-440
- ▶ Contents: 250 ml
- ▶ Packing unit: 12

▶ **Technical specifications**

- Removes deposits and oil residue
- Up to 50% deeper creep effect than e.g. a standard rust remover
- Free from mineral oils, acids and silicones
- Very economical to use thanks to high percentage of active ingredient

02
Penetrating oil
Oxim Protect

- ▶ Item no. 2894-444-1
- ▶ Contents: 400 ml
- ▶ Packing unit: 12

▶ **Product description**

- Thermally stable from -20°C to +250°C
- Use against rust, squeaks and creaks
- Prevents further rusting

03
Rust Loosener Spray
Oxim Ultra

- ▶ Item no. 2894-444
- ▶ Contents: 400 ml
- ▶ Packing unit: 24

▶ **Item no. 2894-441-1**

- ▶ **Contents: 5 litres**
- ▶ **Packing unit: 1**

▶ **Product description**

- Excellent lubricating properties
- Provides good lubricity
- Water-repellent
- Shields against corrosive elements
- Temperature range from -20°C to +250°C

04
Ice-rust remover
Super Crack Ultra

- ▶ Item no. 2894-442-1
- ▶ Contents: 400 ml
- ▶ Packing unit: 12

▶ **Product description**

- Excellent penetrating ability
- Highly effective corrosion protection
- Permanently water repellent
- Guarantees extreme relubricating effect
- Strong icing, cools to -40°C
- High-performance separating agent with silver-coloured aluminium particles



IN THE VIDEO, SCHEUNE HAD A LITTLE JITTERS!!!



04



01

Brake cleaner
Bremtec

- ▶ Item no. 2897-333-600
- ▶ Contents: 600 ml
- ▶ Packing unit: 24

- ▶ Item no. 2897-333-5
- ▶ Contents: 5 litres
- ▶ Packing unit: 1

- ▶ Item no. 2897-333-30
- ▶ Contents: 30 litre
- ▶ Packing unit: 1

- ▶ Item no. 2897-333-60
- ▶ Contents: 60 litres
- ▶ Packing unit: 1

- ▶ **Product description**
- Contains acetone
- Degreasing action
- Carbon dioxide as the propellant



01

02

Metal discharge tap, R3/4"

- ▶ Item no. 2000-000-062

Locking adapter for metal discharge tap

- ▶ Item no. 2000-000-061



02

03

Brake cleaner
Bremtec

- ▶ Item no. 2897-333-31
- ▶ Contents: 30 litres
- ▶ Packing unit: 1

- ▶ **Product description**
- Basis: Benzoles, alcohols
- Ideal for the rapid removal of oil, dirt and brake dust from brake discs, pads and linings, as well as in the area around the intake and throttle valve
- Contains acetone



03

04

Pressure pump spray bottle
1 litre

- ▶ Item no. 2897-333-100

- ▶ **Product description**
- Operational overpressure 3 bar
- Suitable replacement sealant (optionally available): Art. no. 2897-333-101
- Empty
- Capacity 1 litre
- Labels to improve identification separately available
- For filling with the following Normfest products:
 - Bremtec brake cleaner
 - Power-Star tar remover
 - Motor-Fit engine compartment conservation
 - Oxim rust remover

05

Safety cleaner
Bremtec Safe

- ▶ Item no. 2897-333-700
- ▶ Contents: 500 ml
- ▶ Packing unit: 12

- ▶ Item no. 2897-333-730
- ▶ Contents: 30 litre
- ▶ Packing unit: 1

- ▶ **Product description**
- TÜV-tested fire behaviour
- TÜV-tested ingredients
- Flame-retarding propellant
- Lower explosion limit >1.5% Vol.
- Recommended product in accordance with the German Ordinance on Hazardous Materials (protection level 2)
- 25% naphtha- colourless



05



01
Brake cleaner
MC-1

- ▶ Item no. 2897-333-500
- ▶ Contents: 500 ml
- ▶ Packing unit: 30

- ▶ **Product description**
- Acetone-free quality cleaner
 - Very effectively removes oil, dirt, brake fluid and brake dust from brake discs, pads and linings and many other vehicle parts
 - Flushes out contaminants and deposits
 - Removes oil, grease, dust, resin residues/brake fluid/brake dust from disk brakes
 - The life of treated components is increased thanks to conditioning lubrication



01

02
Brake protection paste
Off-Shore Silver

- ▶ Item no. 2894-449-200
- ▶ Contents: 200 g
- ▶ Packing unit: 12

- ▶ **Product description**
- Special lubricant that provides reliable adhesion at high temperatures
 - Condensation, splash and salt water proof
 - Excellent and long-term lubrication
 - Lasting corrosion protection
 - Particularly suitable for vehicles with anti-lock brake system
 - Temperature resistant up to



02

03
Brake protection spray
Off-Shore Silver

- ▶ Item no. 2894-449
- ▶ Contents: 400 ml
- ▶ Packing unit: 12

- ▶ **Product description**
- Condensation, splash and salt water proof
 - Excellent and long-term lubrication
 - Lasting corrosion protection
 - Particularly suitable for vehicles with anti-lock brake system
 - Temperature stability up to 1,400°C
 - Metal-free
 - Prevents corrosion and squeaking
 - Silicone free
 - Cold-flow properties guarantee



03



04

04
Off-Shore replacement brush

- ▶ Item no. 2894-448-201



05

05
Sealable lid
for used aerosol cans

- ▶ Item no. 2897-999
- ▶ **Product description**
- These caps are specially prescribed in VW workshops so that used aerosol cans can be closed in accordance with regulations. This prevents any possible leakage from the cans. Safety is simple - after use - spray head off - cap on!

01
Brake assembly paste
BMP

- ▶ Item no. 2894-400
- ▶ Contents: 5.50 ml
- ▶ Packing unit: 1

- ▶ Item no. 2894-405
- ▶ Contents: 250 g
- ▶ Packing unit: 1

- ▶ **Product description**
- Heat resistant to 1,100°C
- Resistant to alkalis and acids
- Can be universally used for assembly, screw fittings and as a lubricant



01

03
Brake fluid
DOT4

- ▶ Item no. 2894-410
- ▶ Contents: 5 litres
- ▶ Packing unit: 1

- ▶ Item no. 2894-410-30
- ▶ Contents: 30 litre
- ▶ Packing unit: 1

- ▶ **Product description**
- Suitable for all hydraulic braking systems with synthetic fluid
- Wet boiling point over +160°C
- Boiling point over +250°C

04
Brake fluid
DOT4 Plus

- ▶ Item no. 2894-415-05
- ▶ Contents: 500 ml
- ▶ Packing unit: 24

- ▶ Item no. 2894-415
- ▶ Contents: 5 litres
- ▶ Packing unit: 1

- ▶ Item no. 2894-415-30
- ▶ Contents: 30 litre
- ▶ Packing unit: 1
- ▶ **Product description**
- Suitable for all hydraulic braking systems using synthetic fluid
- Wet boiling point over +180°C
- Boiling point over +260°C

05
Spout for 5 litre containers

- ▶ Item no. 2000-000-005

Spout for 30 litre containers

- ▶ Item no. 2000-000-030

06
Brake fluid tester
Replacement battery 3722-24

- ▶ Item no. 8715-999-50



02

02
Copper grease
COP

- ▶ Item no. 2894-451-1
- ▶ Contents: 250 g
- ▶ Packing unit: 1

- ▶ Item no. 2894-450
- ▶ Contents: 400 ml
- ▶ Packing unit: 12

- ▶ Item no. 2894-451
- ▶ Contents: 100 g
- ▶ Packing unit: 10

- ▶ **Product description**
- Thermally stable to +1,200°C
- Do not apply to friction surfaces
- NOT RECOMMENDED FOR ABS VEHICLES



03

04

06

05

01

High-Performance Brake Fluid

DOT 4 LV High Performance

- ▶ Item no. 2894-435
- ▶ Contents: 5 litres
- ▶ Packing unit: 1

- ▶ Item no. 2894-430
- ▶ Contents: 30 litres
- ▶ Packing unit: 1

▶ **Product description**

- With special Ford licence
- Suitable for all hydraulic brake systems using synthetic fluid
- Can be mixed with brake fluid of the same specification
- Does not attack brake parts
- Increases safety thanks to reduced drop in boiling point
- Meets DOT-4 FMVSS 116 and SAEJ 1703
- Boiling point over +265° C
- Wet boiling point over +175° C



05

Airspray automatic filler

- ▶ Item no. 2897-910-100
- ▶ Item no. 2897-910-106
- ▶ Spare parts service station material/air

Replacement parts for Airspray pressure cylinders

- ▶ Item no. 2897-910-101
- ▶ A valve with a vertical hose
- ▶ Item no. 2897-910-102
- ▶ Spray head, circular jet
- ▶ Item no. 2897-910-108
- ▶ Spray head, spot jet

Spare parts for Airspray automatic filling machine

- ▶ Item no. 2897-910-103
- ▶ Material air valve
- ▶ Item no. 2897-910-104
- ▶ Air valve
- ▶ Item no. 2897-910-105
- ▶ Seal holder, including grooved ring
- ▶ Item no. 2897-910-110
- ▶ Barrel connector, including accessories for 60 litres

02

Airspray pressure cylinder for Bremtec A2

- ▶ Item no. 2897-910-1
- ▶ Contents: 400 ml
- ▶ Packing unit: 1



02

03

Airspray pressure cylinder for Bremtec

- ▶ Item no. 2897-910-2
- ▶ Contents: 400 ml
- ▶ Packing unit: 1



03

04

Airspray pressure cylinder for Oxim

- ▶ Item no. 2897-910-3
- ▶ Contents: 400 ml
- ▶ Packing unit: 1



04

06

Pressurised-air spray bottle
Refillable, 8 bar

- ▶ Item no. 2897-900

▶ **Product description**

- Suitable for all liquid materials that can be worked using compressed air



06



05

01

Seal remover

Seal-Ex

- ▶ Item no. 2896-663
- ▶ Contents: 400 ml
- ▶ Packing unit: 12

▶ **Product description**

- Can be used on objects made from metal, wood, ceramic, glass, polyethylene, polypropylene
- Do not use on delicate plastics such as PVC, linoleum or synthetics
- Never use on painted surfaces!

02

Silicone red

Silon Red

- ▶ Item no. 2896-640-1
- ▶ Contents: 200 ml
- ▶ Packing unit: 12

▶ **Product description**

- Hardens practically without shrinking (< 3%) to a hard, rubber-like mass as soon as exposed to air humidity
- Adheres to metal, glass, painted surfaces, ceramic and to most plastic surfaces
- Resistant to weathering, vibrations, moisture
- Thermally stable from -50°C to +300°C

03

Silicone black

Silon Black

- ▶ Item no. 2896-640-2
- ▶ Contents: 200 ml
- ▶ Packing unit: 12

▶ **Product description**

- Hardens practically without shrinking (< 3%) to a hard, rubber-like mass as soon as exposed to air humidity
- Adheres to metal, glass, painted surfaces, ceramic and to most plastic surfaces
- Resistant to weathering, vibrations, moisture
- Thermally stable from -50°C to +230°C

04

Spare pistol grip

- ▶ Item no. 2896-640-3



01



02



03

04



**SILON IS
THE BEST
FOR PROCESSING**

01 Multi-purpose grease BG-B

- ▶ Item no. 2986-02
 - ▶ Contents: 400 g
 - ▶ Packing unit: 12
-
- ▶ Product description
 - Colour: Black
 - Ideal for drive shafts
 - With graphite
 - Thermally stable from -30°C to +120°C
 - NLGI class 2

02 Multi-purpose grease BG-Y

- ▶ Item no. 2986-021
 - ▶ Contents: 400 g
 - ▶ Packing unit: 12
-
- ▶ Product description
 - Color: Yellow
 - Temperature range -30°C to +120°C
 - NLGI class 2

03 Lever-action grease press M10 x 1

- ▶ Item no. 7986-0
-
- ▶ Technical specifications
 - For 400 g cartridges or 500 g of loose grease
 - Short-stroke system
 - Stepless piston rod fixing
 - Filling / bleed valve
 - Ergonomic handle, compliant with DIN 1283
 - TÜV, DLG, BLT tested

04 High pressure reinforced tube

- ▶ Item no. 7986-03
-
- ▶ Product description
 - M10 x 1
 - For grease gun (7986-0)



06 Lever grease gun For lube-shuttle system cartridges

- ▶ Item no. 7986-1
-
- ▶ Product description
 - With galvanized-steel grease container
 - Ergonomically shaped lever gear
 - Pressure approx. 300 bar
 - Open the cartridge without tools
 - Simple, quick and absolutely clean loading and removal of grease cartridges - without opening the gun
 - No venting required
 - Optimal emptying of cartridge residues

07 Multi-purpose grease Greasal

- ▶ Item no. 2986-031
 - ▶ Contents: 400 g
 - ▶ Packing unit: 12
-
- ▶ Product description
 - Smooth texture
 - Soft consistency
 - Acid-free, shear-stable
 - Resistant to oxidation
 - Protects against rust
 - Thermally stable from -30°C to +120°C
 - NLGI class 2 (2K-30 to DIN 51 502)
 - Screw cartridge (lube-shuttle system cartridges)

05 Hydraulic claw mouthpiece

- ▶ Item no. 7986-04
-
- ▶ Product description
 - M10 x 1
 - to DIN 71412
 - for grease guns (7986-0)



01 Surface sealant, green

- ▶ Item no. 2896-520
- ▶ Contents: 50 g
- ▶ Packing unit: 1

▶ **Product description**

- max. gap filling capacity: 0.3 mm
- Thermally stable from -55°C to +150°C
- Resistant to water, mineral oils, synthetic lubricants, fuels, organic solvents and coolants
- Solid in 20-40 mins.
- Work hard in 1-3 hours

02 Surface sealant, orange

- ▶ Item no. 2896-521
- ▶ Contents: 50 g
- ▶ Packing unit: 1

▶ **Product description**

- max. gap filling capacity: 0.5 mm
- Thermally stable from -55°C to +150°C
- Resistant to water, mineral oils, synthetic lubricants, fuels, organic solvents and coolants
- Solid in 15-30 mins.
- Work hard in 1-3 hours

03 Hydraulic and pneumatic sealant
Anaerobic sealing compound

- ▶ Item no. 2896-550-50
- ▶ Contents: 50 ml
- ▶ Packing unit: 10

▶ **Product description**

- Strength class (DIN 30661): 10-14
- max. gap filling capacity: 0.50 mm
- max. thread: (metr) M80
- Thermally stable from -55°C to +150°C
- Solid in 15-30 mins.
- Work hard in 1-3 hours
- Resistant to petrol, diesel, water, water-glycol mixtures, mineral oils, hydraulic fluids



04 Screw-Lock "medium-strength"

- ▶ Item no. 2896-531
- ▶ Contents: 24 ml
- ▶ Packing unit: 1

- ▶ Item no. 2896-531-50
- ▶ Contents: 50 ml
- ▶ Packing unit: 1

▶ **Product description**

- medium strength, strength class (DIN 30661)
- max. gap filling capacity: 0.25 mm
- max. thread (metric) M36
- Thermally stable from -55°C to +150°C
- Solid in 10-20 mins.
- Work hard in 1-3 hours

05 Screw-Lock "high-strength"

- ▶ Item no. 2896-530
- ▶ Contents: 24 ml
- ▶ Packing unit: 1

- ▶ Item no. 2896-530-50
- ▶ Contents: 50 ml
- ▶ Packing unit: 1

▶ **Product description**

- high-strength, strength class (DIN 30661)
- max. gap filling capacity: 0.15 mm
- max. thread (metric) M20
- Thermally stable from -55°C to +150°C
- Solid in 10-20 mins.
- Work hard in 1-3 hours



01



02



03



04



05

01
Pipe thread sealing

- ▶ Item no. 2896-550-51
- ▶ Contents: 50 ml
- ▶ Packing unit: 12

▶ **Product description**

- Strength class (DIN 30661): 10-14
- max. gap filling capacity: 0.50 mm
- Max. thread: (metr) M80
- ?-55°C to +150°C
- Solid in 15-30 mins.
- Work hard in 1-3 hours
- Resistant to petrol, diesel, water, water-glycol mixtures, mineral oils, hydraulic fluids
- Exception: High-concentration acids and alkalis, and methylene chloride



01

02
fastening of the brass and bearing

- ▶ Item no. 2896-540
- ▶ Contents: 24 ml
- ▶ Packing unit: 12

▶ **Product description**

- Strength class (DIN 30661): 55-70
- max. gap filling capacity: 0.15 mm
- max. thread: (metr) M20
- Thermally stable from -55°C to +175°C
- Solid in 2-5 mins.
- Work hard in 1-3 hours



02

03
Duroplastic universal seal with dispensing grommet
Plastomar

- ▶ Item no. 2896-502
- ▶ Contents: 85 g
- ▶ Packing unit: 10

▶ **Product description**

- Temperature stable from -55°C to +270°C
- Allow to evaporate for 10 minutes
- Max. gap filling capacity 0.2 mm
- Silicone-free
- Colour: red



03

04
Engine sealer
MotSeal

- ▶ Item no. 2897-374
- ▶ Contents: 300 ml
- ▶ Packing unit: 12

▶ **Product description**

- Prevents exhaust bluing
- Replenishes rubber and plastic seals
- Stops environmentally-unfriendly oil leaks



04

05
Engine oil cleaner
MotClean

- ▶ Item no. 2897-375
- ▶ Contents: 500 ml
- ▶ Packing unit: 12

▶ **Product description**

- Gentle and quick cleaning
- Safe for seals and other engine materials
- Cost-effective
- Simple application



05

01

Radiator sealer

RadSeal

- ▶ Item no. 2897-372
- ▶ Contents: 150 ml
- ▶ Packing unit: 12

▶ **Product description**

- Seals hairline cracks and small leaks permanently and reliably
- Compatible with anti-freezes and coolants, does not attack rubber, plastics, light alloys or non-ferrous heavy metals
- No negative effects on water pumps or heating circuits
- Suitable for closed cooling systems
- Suitable for aluminium radiators
- Also suitable for precautionary use



01

02

Radiator Cleaner

RadClean

- ▶ Item no. 2897-373
- ▶ Contents: 250 ml
- ▶ Packing unit: 12

▶ **Product description**

- Chemical conversion of lime
- Dissolves grease, lime and oil
- Disperses sludge
- Does not attack radiator materials
- Safe for rubber and plastic
- Compatible with anti-freezes
- Does not contain aggressive acids or alkalis



02

03

Diesel additive

CT 60

- ▶ Item no. 2897-370
- ▶ Contents: 300 ml
- ▶ Packing unit: 12

▶ **Product description**

- Cleans and prevents deposits in the fuel system and combustion chamber
- Keeps the injector nozzles clean, improves combustion, resulting in less specific fuel consumption and maximum engine performance
- Prevents sticky deposits on the injector needles
- Increases lubrication when using low sulphur diesel fuels and protects the distributor fuel injection pumps against wear
- Fully compatible with all modern diesel oxidation catalysts



03

04

Petrol additive

OT 100

- ▶ Item no. 2897-371
- ▶ Contents: 300 ml
- ▶ Packing unit: 12

▶ **Product description**

- Suitable for all petrol injection systems
- Cleans carbon deposits from injection systems
- Removes coking and deposits from fuel distributors, injection valves, intake valves and other components of the fuel system
- Ensures optimum performance and fuel economy through accurate injection and atomization
- Guarantees low exhaust emissions



04



01
Diesel Air-Intake System Cleaner
DC980

- ▶ Item no. 2897-369
- ▶ Contents: 400 ml
- ▶ Packing unit: 8

- ▶ **Product description**
- Special cleaner with CO2 propellant
 - Simple and specific use
 - Colourless and residue free
 - Powerful solvent action
 - Over 95% active ingredients



01

02
Diesel soot-particle filter cleaner
DPF100

- ▶ Item no. 2897-380
- ▶ Contents: 400 ml
- ▶ Packing unit: 12

- ▶ **Product description**
- Outstanding at loosening carbon deposits
 - Non-flammable
 - Clean without having to dismantle the particle filter
 - Restore the full absorbency of the diesel particle filter



02

03
Throttle cleaner
VC 980

- ▶ Item no. 2897-368
- ▶ Contents: 400 ml
- ▶ Packing unit: 12

- ▶ **Product description**
- Cleans the carburettor from the inside and outside
 - Rinses boreholes and nozzles
 - Ideal for cleaning components in the intake area
 - Exhaust gas regulation valve

04
Long hose, incl. spray head for VC 980

- ▶ Item no. 2897-368-1



04

05
Electrical contact cleaner
TermClean

- ▶ Item no. 2897-334
- ▶ Contents: 400 ml
- ▶ Packing unit: 12

- ▶ **Product description**
- Cleans all contacts
 - Facilitates the removal of greasy contamination and loosens old incrustations
 - Safe to use on electrical and mechanical office machines, computers, cash registers, radios and televisions
 - Comes with brush attachment
- Product not suitable for use on parts being used!



05



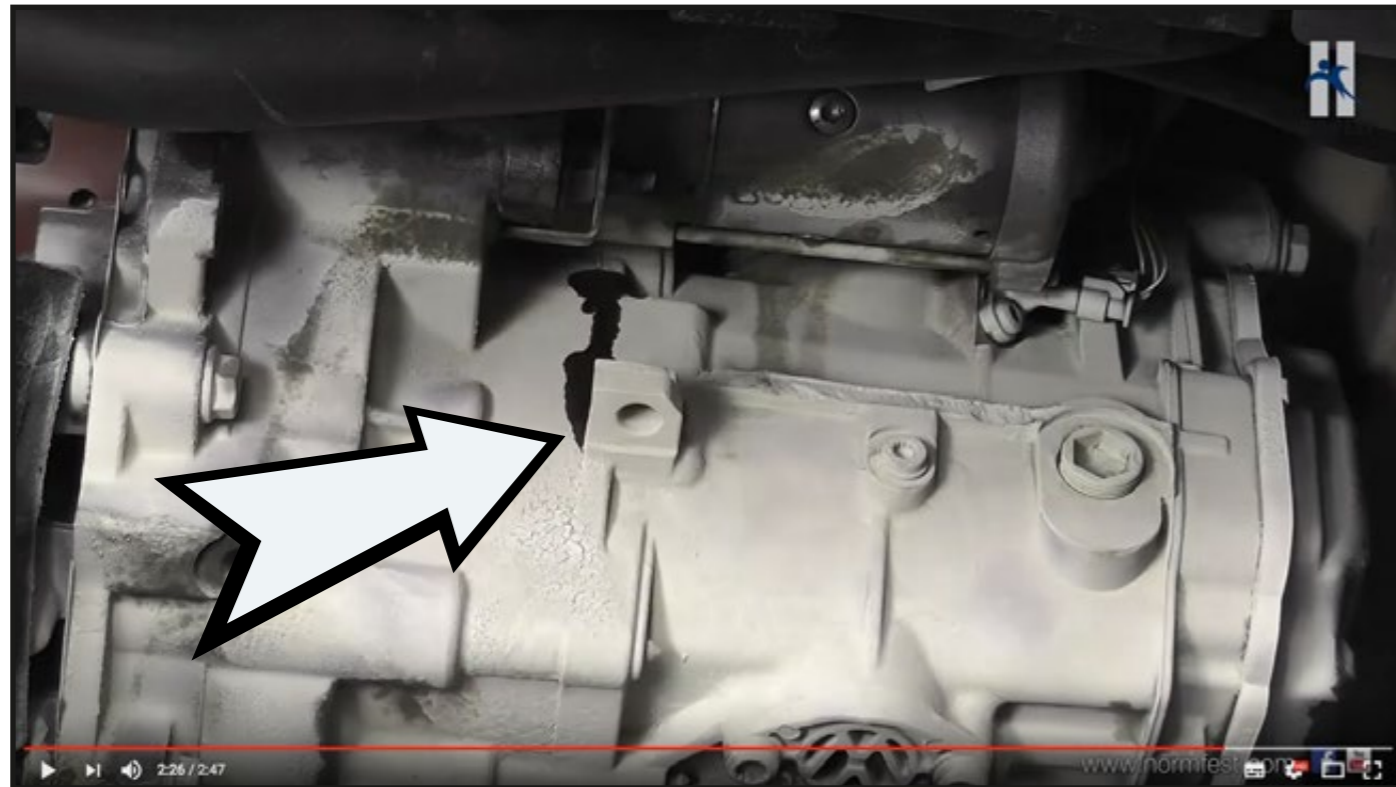

01
Leak-Finder Spray
Spy Dry

- ▶ Item no. 2896-662
- ▶ Contents: 400 ml
- ▶ Packing unit: 12

- ▶ Technical specifications
- Saves time diagnosing leaks
- Non-flammable
- Free from grease and silicone

**WITH THIS PRODUCT
YOU CAN SAVE
VALUABLE TIME!!!**



01

02
Leak Detector
Spy Plus

- ▶ Item no. 2896-661
- ▶ Contents: 400 ml
- ▶ Packing unit: 12

- ▶ Product description
- Meets the requirements of DIN EN 14291
- Non-flammable leak detection possible even of flammable gases
- Suitable for all technical gases in compressed-air, compressed-gas and air-conditioning systems, compressors, welding apparatus, compressed-air brake systems, tyres, hoses and transport tanks
- No stress corrosion cracking on plastics such as PVC or PE
- Temperature range: -15°C to +50°C
- Non-corrosive



02

03
Freezer Spray
Arctic

- ▶ Item no. 2897-325
- ▶ Contents: 200 ml
- ▶ Packing unit: 12

- ▶ Product description
- Metal structural parts such as ball bearings, sleeves, chain links, shafts, etc. can be inserted into the tightest of fits
- Can be used to easily find electrical faults in circuits (due to thermal overload) through local cooling
- Also excellent at removing dirt such as chocolate and chewing gum from upholstery



03

04
Marten repeller spray
Wild Guard

- ▶ Item no. 2897-329
- ▶ Contents: 400 ml
- ▶ Packing unit: 12

- ▶ Technical specifications
- Helps to effectively deter martens
- Double-effect means that electric cables, ignition cables, brake and coolant tubes, sleeves and fan belts are protected from marten bites
- Reapplied after every engine and underbody wash



04



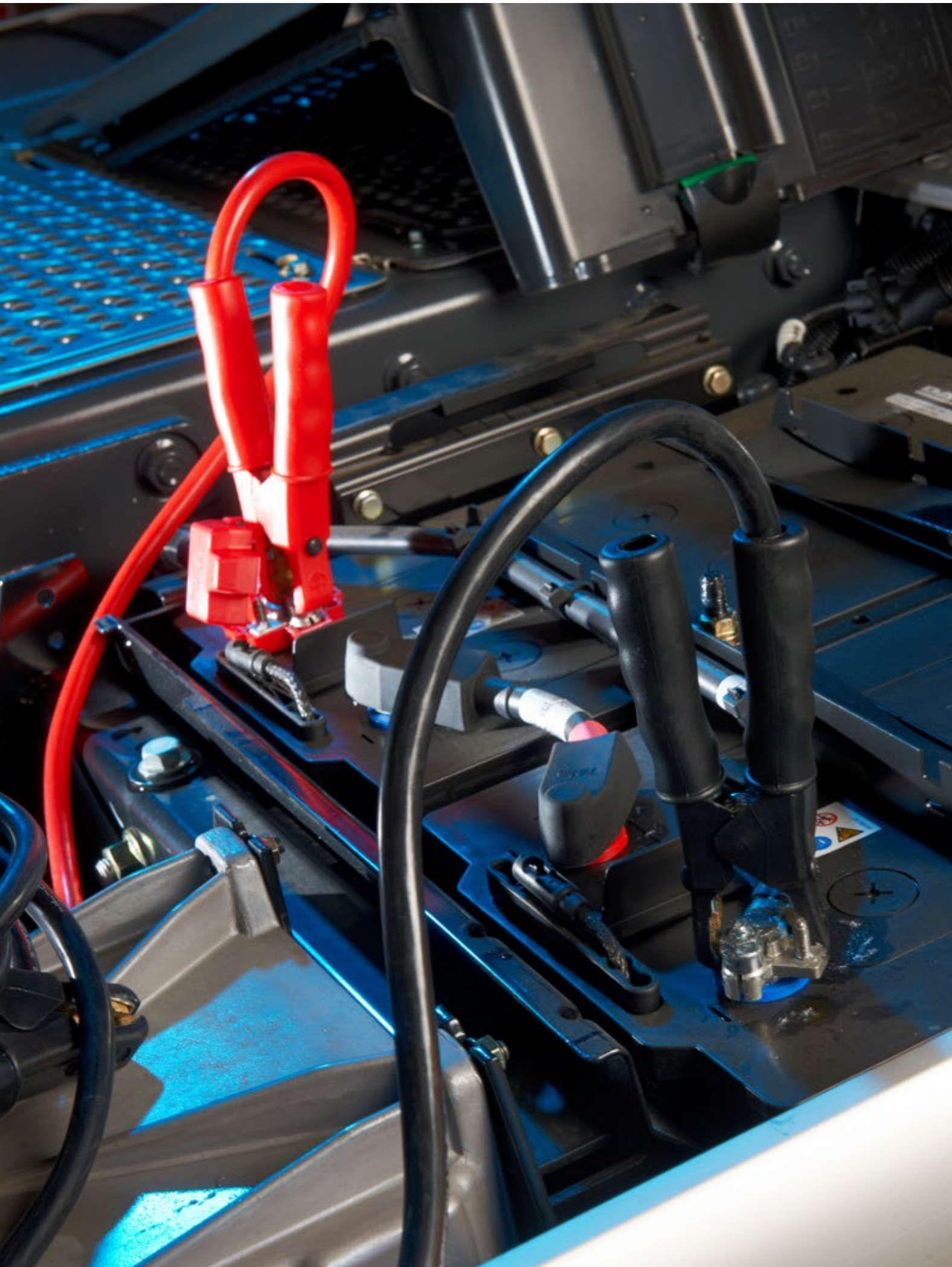

01
Starting aid spray
Super Start Plus

- ▶ Item no. 2897-330-310
- ▶ Contents: 300 ml
- ▶ Packing unit: 12

- ▶ Product description
- Very high ignition properties
 - Facilitates cold starting even in extremely low temperatures
 - Improves starting when wet
 - Suitable for 2- and 4-stroke petrol engines
 - Also suitable for diesel engines (follow instructions for use on the product: ☑Start diesel engines at full throttle, do not preheat!

02
Contact helper
Contac

- ▶ Item no. 2897-331
- ▶ Contents: 300 ml
- ▶ Packing unit: 12

- ▶ Product description
- Eliminates moisture
 - Improves electrical conductivity

03
Battery-terminal protection spray
Poltec

- ▶ Item no. 2897-332-300
- ▶ Contents: 300 ml
- ▶ Packing unit: 12

- ▶ Product description
- insulates bright sheet connections and electrical connections against corrosion from environmental agents (salts, water, acids, alkalis, moisture, etc.)

04
Battery acid tester
▶ Item no. 8853-600-2



01

02

03

04



01 Intensive window cleaner Topas

- ▶ Item no. 2897-310
- ▶ Contents: 400 ml
- ▶ Packing unit: 24

- ▶ Item no. 2000-03
- ▶ Contents: 5 litres
- ▶ Packing unit: 1

- ▶ **Product description**
- Silicone-free
- Also suitable for polycarbonate glass
- Safe for surfaces
- Foam formation only after the surface has been coated with the product



03

01

02 High-tech special cleaner Terpanol Power

- ▶ Item no. 2897-323
- ▶ Contents: 400 ml
- ▶ Packing unit: 12

- ▶ **Product description**
- Contains orange terpene from 100% renewable raw materials
- Effortlessly removes adhesive residue, oil, grease, wax, permanent marker ink (Edding), graffiti
- Deals with the respective dirt effectively and quickly
- Solubilises after a very short time (approx. 20 seconds)



02



03 Spout for 5 litre containers

- ▶ Item no. 2000-000-005



03

04 Sealable lid for used aerosol cans

- ▶ Item no. 2897-999



04

NEU



01 Anti-freeze concentrate for windscreen washing system
Frostex

- ▶ Item no. 2897-312
- ▶ Contents: 500 ml
- ▶ Packing unit: 20

- ▶ Item no. 2897-314
- ▶ Contents: 1000 ml
- ▶ Packing unit: 12

- ▶ Item no. 2897-318
- ▶ Contents: 30 litre
- ▶ Packing unit: 1

- ▶ Item no. 2897-319
- ▶ Contents: 60 litres
- ▶ Packing unit: 1

- ▶ Product description
- Methanol free
- Undiluted frost-proof up to -70°C
- Suitable for fan nozzles and polycarbonate windscreens



01

02 Express de-icer
Blizzard Ultra

- ▶ Item no. 2897-231
- ▶ Contents: 500 ml
- ▶ Packing unit: 6

- ▶ Product description
- De-ices windscreens quickly
- Leave no smears
- No need to scrape off frost, ice or snow



02

03 Anti-freeze tester for cooling water

- ▶ Item no. 8853-600-1



03

05 Dispensing pump for 5-litre container

- ▶ Item no. 2897-313-509

- ▶ Product description
- 1 spray (2.5 ml)



05

04 Anti-freeze for windscreen washer systems

- ▶ Item no. 8853-600-3



04

06 Windscreen washing system concentrate
Flash

- ▶ Item no. 2897-313-100
- ▶ Contents: 30 ml
- ▶ Packing unit: 100

- ▶ Item no. 2897-313-5
- ▶ Contents: 5 litres
- ▶ Packing unit: 1

- ▶ Product description
- Summer product – only suitable for temperatures above 7°C
- Suitable for fan nozzles and polycarbonate windscreens
- One bottle (30 ml) = 4 litres of water



06



01



02



03



06



07



08

01 Super-fast superglue
Cyanacrylate adhesives black

- ▶ Item no. 2898-555
- ▶ Contents: 5 g
- ▶ Packing unit: 1

- ▶ Item no. 2898-556
- ▶ Contents: 20 g
- ▶ Packing unit: 1

- ▶ **Product description**
- Suitable for smooth plastic surfaces
- Pinpoint application accuracy

02 Black cyanacrylate adhesive Superfast

- ▶ Item no. 2898-560-20
- ▶ Contents: 20 g
- ▶ Packing unit: 1

- ▶ **Product description**
- Suitable for bonding rubber coatings, plastics and metals

- Ideal for bonding plastics, such as door clips
- Based on cyanacrylate

03 Superglue filler
For cyanoacrylate adhesives

- ▶ Item no. 2898-560-30
- ▶ Contents: 30 g
- ▶ Packing unit: 1

- ▶ **Product description**
- Density: > 1.5g/cm³ 20°C

06 Superglue gel
Fixit

- ▶ Item no. 2898-554
- ▶ Contents: 20 g
- ▶ Packing unit: 1

- ▶ **Product description**
- Does not run
- Can be used on horizontal and vertical surfaces
- Does not form strings
- For bonding metals, wood and plastics
- Based on cyanacrylate

07 Accelerator
Fixit Active

- ▶ Item no. 2898-554-150
- ▶ Contents: 200 ml
- ▶ Packing unit: 1

- ▶ **Product description**
- Suitable as a curing accelerator for all cyanacrylate adhesives
- For leather, wood, cork, ceramics and all porous materials and for bonding plastics

08 Power spray adhesive
Super-Glue

- ▶ Item no. 2898-552
- ▶ Contents: 400 ml
- ▶ Packing unit: 12

- ▶ **Product description**
- Foamed materials, jute, felt, expanded polystyrene
- Paper, cardboard, plastic films
- Various plastics
- Temperature range (permanent): -25°C to +70°C

04 Extreme cyanoacrylate superglue
Rapido

- ▶ Item no. 2898-555-100
- ▶ Contents: 20 g
- ▶ Packing unit: 12

- ▶ **Product description**
- For extreme loads and flexible adhesions
- Basis: cyanoacrylate



04



05

05 Rubber profile adhesive
Profix

- ▶ Item no. 2898-551
- ▶ Contents: 180 g
- ▶ Packing unit: 12

- ▶ **Product description**
- Ideal for gluing: Rubber profile, leather, plastic, imitation leather with textile backing and felt to metal, wood, rigid PVC, ABS, PA

09 Two-component cyanoacrylate adhesive 2-c CA

- ▶ Item no. 2700-25
- ▶ Contents: 10 g
- ▶ Packing unit: 1

- ▶ **Product description**
- Rapid hardening
- For up to 6 mm gaps
- Gel consistency (for work on vertical surfaces)
- No drips
- Accurate and clean application using the mixer nozzle
- Perfect for all quick repairs to damaged components and for emergency repairs
- Outstanding adhesive properties for almost every current material
- Handling time: 90 - 150 seconds, depending on the

NEU

10 Mix nozzles, 10 pieces

- ▶ Item no. 2700-25-1



09

01

Multipurpose primer

1K-Multi-Connector

- ▶ Item no. 2893-900 Light grey
- ▶ Contents: 400 ml
- ▶ Packing unit: 12



- ▶ Item no. 2893-900-20 Dark grey
- ▶ Contents: 400 ml
- ▶ Packing unit: 12



▶ **Product description**

- Recoatable without sanding
- With fan spray head
- Substrates: Galvanised sheet steel and aluminium, plastic, wood, etc.
- Particularly suitable for protecting the edges of filled areas
- Ideal for all difficult substrates, also suitable for plastic and wood

02

Aluminium undercoat

Alloy

- ▶ Item no. 2893-881
- ▶ Contents: 400 ml
- ▶ Packing unit: 12

▶ **Product description**

- Heat-resistant corrosion protection up to +600°C
- Weldable
- Overpaintable
- Protects new sheet metal against corrosion

03

Zinc primer

Galva 97

- ▶ Item no. 2893-880
- ▶ Contents: 400 ml
- ▶ Packing unit: 12

▶ **Product description**

- Protects new sheet metal against rusting
- Weldable
- Abrasion resistant after drying
- High corrosion protection
- High percentage of active substances

03

Zinc-aluminium undercoat

Galva 97 Silver

- ▶ Item no. 2893-890
- ▶ Contents: 400 ml
- ▶ Packing unit: 12

▶ **Product description**

- Ideal for colour matching to galvanised sheet metal
- Protects new sheet metal against corrosion
- Weldable
- Abrasion resistant after drying
- High corrosion protection
- High percentage of active substances



01



02



03



04

GALVA PROTECTS NEW SHEET METAL AGAINST RUST!



01

Two-Component Primer Filler

2K Rapid Filler

- ▶ Item no. 2893-905
- ▶ Contents: 400 ml
- ▶ Packing unit: 6

▶ **Product description**

- Isocyanate-free
- Very rapid curing after 1 hour at 20°C
- or after 15-20 mins. at 60°C
- Universal use on old sanded paintwork and metallic substrates
- Simple and quick to use
- Very high filling capacity
- Very good adhesion on bright steel/plate
- Can be overpainted with any current 1K and 2K covering-paint systems

02

Primer filler

2-component epoxy primer filler

- ▶ Item no. 2800-760
- ▶ Contents: 400 ml
- ▶ Packing unit: 6

▶ **Product description**

- Gloss level: matt
- Colour: beige
- Long-lasting corrosion protection on all surfaces, e.g. zinc, aluminium, steel, etc.
- Proportion of solid particles: 50-53% by weight on diluted paint (without propellant gas)

03

Thick film filler

One-component multi filler

- ▶ Item no. 2893-902
- ▶ Contents: 400 ml
- ▶ Packing unit: 10

▶ **Product description**

- High filling volume
- Easy to sand
- Quick drying
- With cone spray head



04

Pistol grip

- ▶ Item no. 2893-900-2



05

Fan nozzle

- ▶ Item no. 2893-900-3



06

NEU

06

Sealable lid

for used aerosol cans

- ▶ Item no. 2897-999



01



02



03

04



01
Base primer
Baso Plus

- ▶ Item no. 2893-889
- ▶ Contents: 400 ml
- ▶ Packing unit: 24

- ▶ Product description
- High filling properties
- Improved coverage due to increased number of pigments
- Temperature resistant up to 100°C
- Overpaintable with nitro, acrylic and water-based paints
- Fan spray head enables vertical and horizontal application

**THE 2-C RAPID FILLER
CAN BE FOUND ON PAGE 5
OF THIS CHAPTER!**



01

02
Rust-Stop Primer
Rednox

- ▶ Item no. 2893-888
- ▶ Contents: 400 ml
- ▶ Packing unit: 12

- ▶ Item no. 2893-888-25
- ▶ Contents: 2.5 kg
- ▶ Packing unit: 1

- ▶ Product description
- Quick drying
- Weldable
- Overpaintable
- Sprayable



02

03
Rust converter
Rostinator

- ▶ Item no. 2893-903
- ▶ Contents: 400 ml
- ▶ Packing unit: 12

- ▶ Product description
- Active pigments turn rust into iron sulphide
- Forms a permanent weatherproof and moisture-resistant protective layer
- Drying time: 14 hours
- Compatible with all Normfest primers



03

04
Welding Primer
Elox Plus

- ▶ Item no. 2893-906
- ▶ Contents: 400 ml
- ▶ Packing unit: 12

- ▶ Product description
- 1K acrylic base
- Very good corrosion protection
- Can be over welded over
- Very good ignitability & conductivity
- Suitable for iron and steel
- Quick drying
- Visually matches stainless-steel parts



04



01 Underseal, can be painted over
Bottom Guard Recoat

- ▶ Item no. 2892-881
- ▶ Contents: 500 ml
- ▶ Packing unit: 12



- ▶ **Product description**
- Provides optimum underbody protection with anti-rust and anti-corrosion properties
 - Improves sound insulation
 - Rust-protection spray dries quickly and is extremely resistant to abrasion
 - Has very good adhesion to all substrates, such as bumpers / front and rear aprons
 - The underbody spray can be overpainted after 60-90 minutes using two-component and basic paints

02 Underseal, recoatable
Bottom Guard Recoat

- ▶ Item no. 2892-882
- ▶ Contents: 1000 ml
- ▶ Packing unit: 12



- ▶ Item no. 2892-883
 - ▶ Contents: 1000 ml
 - ▶ Packing unit: 12
- ▶ **Product description**
- Provides optimum underbody protection with anti-rust and anti-corrosion properties
 - Outstanding sound insulation
 - Extremely resistant to abrasion
 - Quick drying
 - Can be overpainted with current two-component and basic paints after approx. 60-90 minutes (at 20°C, 65% rel. air humidity)
 - Rubber base



03 Water-based underbody protection
Can be painted over
Bottom Guard Protect

- ▶ Item no. 2892-995
- ▶ Contents: 1000 ml
- ▶ Packing unit: 12



- ▶ **Product description**
- Dark grey
 - Water-based
 - Quick-drying
 - With corrosion protection
 - Can be painted over with conventional 2K acrylic paints, base paints and water-based paints
 - Can be sanded after drying
 - Extremely elastic and durable after hardening
 - Temperature resistant from -25°C to +120°C
 - Low-odour
 - Touch-dry (20°C, 65% RH) after approx. 90-120 minutes
 - Fully hardened depending on the layer thickness at (20°C, 65% RH) in approx. 7 days



01

Wax-based underbody protection

Bottom Guard Wax

- ▶ Item no. 2892-994-1
- ▶ Contents: 1000 ml
- ▶ Packing unit: 12

Transparent



- ▶ Item no. 2892-994-2
- ▶ Contents: 1000 ml
- ▶ Packing unit: 12

Black



- ▶ Item no. 2892-994-3
- ▶ Contents: 500 ml
- ▶ Packing unit: 12

Transparent



▶ **Product description**

- Corrosion protection even with thin material layer
- High creep capacity & self-healing effect
- Thermally stable from -25°C to +180°C
- Can be used on PVC underbody coatings
- No drips one hour after application
- Touch-dry: approx. 2.5 hours
- Completely dry: approx. 24 hours

02

Underbody protection (cannot be painted over)

Bottom Guard

- ▶ Item no. 2892-990
- ▶ Contents: 1,000 ml black
- ▶ Packing unit: 12

Black



▶ **Product description**

- Cannot be overpainted
- Contains solvents
- Bitumen base
- After curing, thanks to its combination of raw materials, the coating provides abrasion-resistant, permanently elastic corrosion protection with high resistance to ageing, which does not become brittle even when cold.

03

Body protection

Long-Life

- ▶ Item no. 2892-997-1
- ▶ Contents: 400 ml
- ▶ Packing unit: 12

▶ **Product description**

- Displaces water
- Creep-capable
- Quick drying
- Thermally stable from -50°C to +90°C
- Extremely abrasion resistant
- For sealing large areas of bodywork



01

02

03



01
Water-based cavity protection
Protector Protect

- ▶ Item no. 2892-999
- ▶ Contents: 1000 ml
- ▶ Packing unit: 12

- ▶ Technical specifications
- Water based & environmentally friendly
- Capable of extreme creep
- Outstanding corrosion resistance
- Low odour
- Almost tack-free after flashing off
- Almost transparent when dry
- Processing tools can be cleaned with water directly after working
- Very low VOCs (volatile organic compounds, a collection of light materials containing carbon)

NEU



01

02
Cavity protection
Protector

- ▶ Item no. 2892-998
- ▶ Contents: 1000 ml
- ▶ Packing unit: 12

- ▶ Product description
- Thermally stable from -25°C to +160°C
- Designed to protect and seal pillars, door sills, areas of the vehicle interior, etc..
- Excellent penetration properties



02

03
Cavity protection
Protector

- ▶ Item no. 2892-997
- ▶ Contents: 400 ml
- ▶ Packing unit: 15

- ▶ Product description
- Thermally stable from -30°C to +90°C
- The hose supplied ensures application even in hard-to-reach cavities
- Facilitates optimal wetting of areas to be protected
- Contains NO silicone!
- Transparent





03

01

Chassis glue & sealing compound Basis: Polyurethane

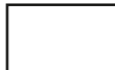
Proton Protect

- ▶ Item no. 2893-225-1 White 
- ▶ Contents: 300 ml
- ▶ Packing unit: 12

- ▶ Item no. 2893-225-2 Black 
- ▶ Contents: 300 ml
- ▶ Packing unit: 12

- ▶ Item no. 2893-225-3 Grey 
- ▶ Contents: 300 ml
- ▶ Packing unit: 12

▶ **Product description**

- for primed and painted metals, aluminium, wooden materials and thermosetting plastics, standard structural mineral substrates
- Can be overpainted once cured
- Adheres to a wide variety of materials
- Good resistance to moisture and weathering
- Thermally stable from -40°C to +90°C (to +120°C in the short term)
- CE mark to EN 15651 Part 1

NEU



02



01



02

Round nozzle

For aluminium cartridge, embossed, length: 8.2 cm

- ▶ Item no. 2891-02-25

03

UV-resistant chassis glue & sealing compound

Basis: MS polymer

Krypton Protect

- ▶ Item no. 2893-226-1 White 
- ▶ Contents: 310 ml
- ▶ Packing unit: 12

- ▶ Item no. 2893-226-2 Transparent 
- ▶ Contents: 310 ml
- ▶ Packing unit: 12

- ▶ Item no. 2893-226-3 Grey 
- ▶ Contents: 310 ml
- ▶ Packing unit: 12

- ▶ Item no. 2893-226-4 Black 
- ▶ Contents: 310 ml
- ▶ Packing unit: 12

▶ **Technical specifications**

- Good adhesion to glass, many metals (zinc, aluminium, steel), paints, primers and wooden materials
- Resistant to moisture and weathering
- Good adhesion to duroplastics and thermoplastics (apart from PE, PP, PTFE) and mineral substrates
- Temperature stability: -40°C to +90°C
- Skin formation: 20 minutes
- Curing: 3 mm/24 h > Curing: 3 mm/24 h
- Shore hardness A: 60
- Elongation at tear: 300%
- Tensile strength: 1.9 N/mm²
- Tear-propagation resistance: 12 N/mm

NEU



04



03

**SEALING COM-
POUNDS
FROM OUR
PROTECT SERIES!**



04

Round nozzle

Basis: polyurethane

- ▶ Item no. 2891-02-26

01

UV-resistant and sprayable joint sealant

Basis: Mixed polymer

Flexon Protect

- ▶ Item no. 2893-310
- ▶ Contents: 310 ml
- ▶ Packing unit: 12

Grey



- ▶ Item no. 2893-311
- ▶ Contents: 310 ml
- ▶ Packing unit: 12

Black



▶ **Technical specifications**

- Elastic
- Can be sanded
- Silicone free
- Adheres to many metals (zinc, aluminium, steel), paints, primers, glass, wood, plastics (apart from PE, PP, PTFE) and mineral substrates
- Temperature stability: -40°C to +80°C, to +120°C in the short term
- Skin formation after 20 minutes
- Can be overpainted (recommendation: It should be overpainted within the first 2 hours otherwise there may be difficulties in adhesion with some paint systems)

**ELASTIC,
CAN BE SANDED,
SILICONE FREE!**

NEU



01

02

Body adhesive

Pluton

- ▶ Item no. 2893-223-4
- ▶ Contents: 280 ml
- ▶ Packing unit: 12



▶ **Product description**

- High strength after 30 mins.
- Adheres without a primer to steel, aluminium, galvanized plate, GFRP and plastics
- Can be overpainted
- Permanently thermally stable up to +80°C
- Can be welded



02

03



03

For plastic cartridges

For use with body sealing compounds, windscreen adhesives and sprayable seam sealants

- ▶ Item no. 2891-03-1



05

Wing nozzle

For achieving wide and flat sealing compound seams

- ▶ Item no. 2891-02-27

04



04

Square spatula

for Pluton

- ▶ Item no. 2893-223-38

▶ **Product description**

- Length: Mixer rod 23 cm
- Diameter at tip: approx. 0.5 cm
- Diameter of adapter: 2.2 cm

06



06

Cartridge opener

- ▶ Item no. 2891-02-50



01
Bonding-surface cleaner
Glue-Ex

- ▶ Item no. 2893-200-10
- ▶ Contents: 1000 ml
- ▶ Packing unit: 12

- ▶ **Product description**
- The ideal cleaner for cleaning surfaces before being stuck
- Can be used on all substrates in the automotive area, apart from plastics
- Transparent



01

02
Adhesive cleaner
HR 150

- ▶ Item no. 2700-36
- ▶ Contents: 150 ml
- ▶ Packing unit: 1

- ▶ **Product description**
- Cleans and simultaneously primes
- Ideal for pre-treating non-absorbent metal and plastic substrates



02

03
Drilling and Cutting Aid
Easy-Cut

- ▶ Item no. 2894-443
- ▶ Contents: 350 ml
- ▶ Packing unit: 12

- ▶ **Product description**
- Supports swarf removal
- Reduces friction between drill bit and workpiece
- Drill bit and workpiece are lubricated and cooled
- Clear extension of service life
- Corrosion protection for the drill hole



03

04
Tinsol - Filling Solder Substitute

Tinsol is the new repair method for metal bodywork.

- ▶ Item no. 2893-224-1
- ▶ Contents: 250 ml
- ▶ Packing unit: 1

- ▶ **Product description**
- Pot life of 50 minutes at 23°C
- Moisture-resistant and weatherproof
- Temperature range -30°C to +120°C
- (temporarily up to +180°C)



04

05
Oxy-fuel gas
Extra hot

- ▶ Item no. 8714-608-600
- ▶ Contents: 600 ml
- ▶ Packing unit: 24

- ▶ **Product description**
- Max. temperature 2,000°C
- Mixture of propane, butane, acetone and isobutane
- Suitable for tin-plating and brazing
- Extra hot



05

06
Butane gas

- ▶ Item no. 8714-607-100
- ▶ Contents: 100 ml
- ▶ Packing unit: 12

- ▶ **Product description**
- Suitable for all common hot-melt and soldering guns



06



01
Plastics repair adhesive
Repos fast

- ▶ Item no. 2700-15
- ▶ Contents: 50 ml
- ▶ Packing unit: 2

- ▶ **Product description**
- For sticking PVC, GFRP, steel and aluminium
- The material is highly elastic
- Setting time: 90 seconds
- Can be sanded after roughly 15 minutes

02
Plastics repair adhesive
Repos fast

- ▶ Item no. 2700-16
- ▶ Contents: 25 ml
- ▶ Packing unit: 1

- ▶ **Product description**
- Setting time: 90 seconds
- Sandable after 60 minutes

03
Structural adhesive
Repos MMA

- ▶ Item no. 2700-20
- ▶ Contents: 50 ml
- ▶ Packing unit: 2

- ▶ **Product description**
- For sticking PVC, GFRP, steel and aluminium
- The material becomes rigid
- Thermally stable: -50°C to +120°C
- For the bonding of different substrates, such as: sun-visor holders, plastic cladding, carbon on steel, aluminium parts on steel substrates and much more
- Can be used without chemical or mechanical pre-treatment
- At 35 Mpa has enormous combined tension and shear resistance
- No solvents or volatile organic compounds
- Processing temperature: +10°C to +30°C
- Touch dry after approx. 15 minutes
- Cured in approx. 24 hours
- Oil resistant



04
Plastics repair adhesive
Repos

- ▶ Item no. 2700-10
- ▶ Contents: 50 ml
- ▶ Packing unit: 2

- ▶ **Product description**
- For sticking PVC, GFRP, steel and aluminium
- The material is highly elastic
- Setting time: 5 minutes
- Can be sanded after roughly 90 minutes



REPOS MMA LETS CARS FLY. WATCH THE VIDEO!





01
Windscreen adhesive
Screenox Quantum

- ▶ Item no. 2893-506-10
- ▶ Contents: 300 ml
- ▶ Packing unit: 12

▶ **Product description**

- Single-component PUR windscreen adhesive
- Compatible with MS polymers and thus workable on cut-back residual MS adhesive bead
- Very easy ejection
- No activator needed
- 60 min. for double airbag in temperature range of -10°C to +35°C
- Processing time: 15 minutes
- Cures down to -10°C
- Very good stability
- Meets OEM/automotive manufacturer requirements
- Very short thread breaks
- Very strong
- Suitable for aerials
- Can be processed cold
- Non-conducting
- Solvent-free

02
Windscreen adhesive
Screenox Quantum

- ▶ Item no. 2893-506-30
- ▶ Contents: 400 ml
- ▶ Packing unit: 12



03
Windscreen adhesive set: Cartridge

- ▶ Item no. 2893-506-20
- ▶ Contents: 5 pieces
- ▶ Packing unit: 24

- ▶ **Set contents:**
- 1 x Screenox Quantum windscreen adhesive, 300 ml cartridge
 - 1 x 3 in 1 multiprimer in 5 ml snap ampoule
 - 1 x primer brush
 - 1 x cartridge point
 - 1 x instructions

04
Windscreen adhesive set: Bag

- ▶ Item no. 2893-506-40
- ▶ Contents: 5 pieces
- ▶ Packing unit: 24

- ▶ **Set contents:**
- 1 x Screenox Quantum windscreen adhesive, 400 ml bag
 - 1 x 3in1 multiprimer in ml snap ampoule
 - 1 x Primer brush
 - 1 x Cartridge point
 - 1 x Instructions



01 + 03



02 + 04





01
Windscreen adhesive
Screenox Cold - New Generation

- ▶ Item no. 2893-504-10
- ▶ Contents: 300 ml
- ▶ Packing unit: 12

▶ **Product description**

- Drive-away time: without airbag 60 minutes, with twin airbag 2 hours
- Temperature range: -10°C to +30°C
- Pot life: 15 minutes
- High modulus
- Suitable for aerials
- Short cut-off string
- Stability meets the requirements of OEMs (vehicle manufacturers)
- Incl. tips

02
Windscreen adhesive package
Screenox Cold - New Generation

- ▶ Item no. 2893-504-30
- ▶ Contents: 400 ml
- ▶ Packing unit: 12



03
Windscreen adhesive set
Cartridge

- ▶ Item no. 2893-504-20
- ▶ Contents: 7 pieces
- ▶ Packing unit: 24

- ▶ **Set contents:**
- 1 x 300 ml cartridge of Screenox Cold - New Generation windscreen adhesive
 - 1 x 3in1 multiprimer in 5 ml snap ampoule
 - 1 x Primer brush
 - 1 x Cartridge point
 - 1 x Instructions



04
Windscreen adhesive set
Bag

- ▶ Item no. 2893-504-40
- ▶ Contents: 7 pieces
- ▶ Packing unit: 24

- ▶ **Set contents:**
- 1 x 400 ml bag of Screenox Cold - New Generation windscreen adhesive
 - 1 x 3in1 multiprimer 30 ml
 - 1 x Primer brush
 - 1 x Bag adapter
 - 1 x Instructions





01
3 in 1 combi primer
Colour: black

- ▶ Item no. 2893-580-30
- ▶ Contents: 30 ml
- ▶ Packing unit: 24

- ▶ Item no. 2893-580-100
- ▶ Contents: 100 ml
- ▶ Packing unit: 8

- ▶ **Product description**
- Adhesion promoter, rust protection, black primer (UV protection) and corrosion protection in one
- Quick to use and increased safety with just one pre-treatment product
- can be used on ceramic screen print, glass and bright metal



02
Brush
For primer, made from cotton

- ▶ Item no. 2893-540



04
Glass Metal Adhesive
Mirrlock

- ▶ Item no. 2898-557

- ▶ **Product description**
- 2-component adhesive
- Temperature range: -55°C to +120°C
- Touch dry after approx. 20 seconds
- Curing: approx. 12 hours at 23°C and 55% air humidity
- Tensile strength: approx. 35 N/mm² (glass breaks)

- Note: Not suitable for Ford vehicles!

03
Washer sealant
Screenfit

- ▶ Item no. 2893-220
- ▶ Contents: 310 ml
- ▶ Packing unit: 12

Black



- ▶ **Product description**
- Can be dabbed
- Resistant to water, road salt and weathering
- After curing, thermally stable from -30°C to +80°C



04



01
Active cleaning cloths
Jumbo pail

- ▶ Item no. 2897-260-70
 - ▶ Contents: 75 wipes
 - ▶ Packing unit: 1
-
- ▶ **Product description**
- Lemon-scented
 - Lint-free
 - Dermatologically tested
 - Cleaning cloths easily remove even bodywork, plastic and windscreen adhesive residue



01



02
Intensive window cleaner
Topas

- ▶ Item no. 2897-310
 - ▶ Contents: 400 ml
 - ▶ Packing unit: 24
-
- ▶ Item no. 2000-03
 - ▶ Contents: 5 litres
 - ▶ Packing unit: 1
-
- ▶ **Product description**
- Silicone-free
 - Also suitable for polycarbonate glass
 - Safe for surfaces
 - Foam formation only after the surface has been coated with the product



02

03
Glass cleaner
Stries Protect

- ▶ Item no. 2897-340
 - ▶ Contents: 500 ml
 - ▶ Packing unit: 12
-
- ▶ Item no. 2897-340-5
 - ▶ Contents: 5 litres
 - ▶ Packing unit: 1
-
- ▶ **Product description**
- Removes dirt, marks, fingerprints, grease, nicotine, dead insects, etc.
 - Free of silicone and ammonia
 - Can be used on glass, polycarbonate glass



03



04

04
Spout for 5 litre containers

- ▶ Item no. 2000-000-005

Spout for 30 litre containers

- ▶ Item no. 2000-000-030

01

Scratch Off Ultra

Grinding paste, coarse

- ▶ Item no. 2000-341
- ▶ Contents: 1 kg
- ▶ Packing unit: 1

▶ **Technical specifications**

- Removes deep and heavy scratches
- Removes scratches completely (without fillers)
- Can be processed without water
- Long process time
- Leaves behind a unique deep gloss
- Silicone-free
-
- Rotary machines: 1,500 – 2,000 rpm
- Excenter machines: 1,700 – 2,200 rpm

Processing

Spider sponge
Polishing sponge, yellow
Natural lambskin

Repolishing

Microfibre cloth red
Microfibre cloth blue



01

02

Scratch Off Medium

Grinding paste, medium

- ▶ Item no. 2000-342
- ▶ Contents: 1 kg
- ▶ Packing unit: 1

▶ **Technical specifications**

- Removes medium scratches
- Removes scratches completely (without fillers)
- Can be processed without water
- Long process time
- Leaves behind a unique high-gloss finish
- Silicone-free
-
- Rotary machines: 1,000 – 1,800 rpm
- Excenter machines: 1,700 – 2,200 rpm

Processing

Spider sponge
Polishing sponge, yellow
Polishing sponge, orange

Repolishing

Microfibre cloth red
Microfibre cloth blue



02

03

Scratch Finish

Grinding paste, fine

- ▶ Item no. 2000-343
- ▶ Contents: 1 kg
- ▶ Packing unit: 1

▶ **Technical specifications**

- Removes light scratches
- Removes scratches completely (without filler)
- Long process time
- Leaves behind an excellent high gloss
- Can be processed by hand
- Silicone and wax-free
-
- Rotary machines: 800 – 1,500 rpm
- Excenter machines: 1,700 – 2,200 rpm

Processing

Waffle sponge
Polishing sponge, black
Polishing sponge, orange



03

I LOVE THESE PRODUCTS



01

Perfect Gloss

High-gloss polish

- ▶ Item no. 2000-344-500
- ▶ Contents: 500 ml
- ▶ Packing unit: 1

- ▶ Item no. 2000-344-1
- ▶ Contents: 1 litre
- ▶ Packing unit: 1

- ▶ Item no. 2000-344-5
- ▶ Contents: 5 litres
- ▶ Packing unit: 1

▶ **Technical specifications**

- Removes holograms
- Leaves behind a long-lasting deep gloss
- Can be processed by hand
- Contains no volatile silicones
- Long-lasting protection
-
- Rotary machines: 800 – 1,500 rpm
- Excenter machines: 1,700 – 2,200 rpm

02

Push-pull closure

Colour: white

- ▶ Item no. 2000-356-2



Processing

Waffle sponge

Polishing sponge, black

Application sponge, black



03

Starter kit for paint preparation

11-piece kit

- ▶ Item no. 2000-003

Contents:

- 1x Coarse grinding paste, Scratch Off Ultra
- 1x Medium grinding paste, Scratch Off medium
- 1x Fine grinding paste, Scratch Finish
- 1x High-gloss polish, Perfect Gloss
- 1x Polishing foam
- 1x Medium polishing cloth, orange
- 1x Soft polishing cloth, black
- 1x Hard polishing cloth, yellow
- 1x Lambskin, white
- 1x Premium micro-fibre cloth
- 1x Microfibre cloth, red



01

03

01

Quick sealant
Speed-Gloss-Nano

- ▶ Item no. 2000-316-1
- ▶ Contents: 1 litre
- ▶ Packing unit: 1

- ▶ Item no. 2000-316-5
- ▶ Contents: 5 litres
- ▶ Packing unit: 1

▶ **Product description**

- Perfect shine effect
- Effortless polishing without leaving any sticky residue
- Suitable for cleaning without water
- Contains carnauba wax

Processing

Application sponge, black
Premium microfibre cloth, grey

02

Wax sealing
Speed-Wax

- ▶ Item no. 2000-330-1
- ▶ Contents: 1 kg
- ▶ Packing unit: 1

▶ **Product description**

- Natural carnauba wax, enriched with high-quality synthetic components
- For manual and machine application
- Permanent protection against the elements
- Long-lasting shine

- Rotary machines: 1,500 – 2,000 rpm
- Excenter machines: 1,700 – 2,200 rpm

Processing

Waffle sponge
Polishing sponge, black
Application sponge, black
Microfibre cloth, grey

03

Long-term sealant
Paint Guard

- ▶ Item no. 2000-331-500
- ▶ Contents: 500 ml
- ▶ Packing unit: 1

▶ **Technical specifications**

- Application by hand
- Extra UV protection for long-lasting maintenance of the paint layer
- Leaves behind a deep gloss
- Free of volatile silicones

Processing

Application sponge, black
Premium microfibre cloth, grey

04

Long-term surface-protection sealant
Pearl

- ▶ Item no. 2897-327
- ▶ Contents: 500 ml
- ▶ Packing unit: 6

▶ **Product description**

- Protective coating & gloss enhancer
- Increases scratch resistance and repels dirt
- Easy to apply and polish
- Takes just 10 minutes to cure
- Solvent free
- Contains silicone

Processing

Premium microfibre cloth, grey



01



02



03



04



01

Spray polish

Polit

- ▶ Item no. 2897-326
- ▶ Contents: 400 ml
- ▶ Packing unit: 12

▶ **Product description**

- Extremely quick and easy to use
- Antistatic
- Produces a uniquely deep shine
- High resistance to scratches and wear
- Contains silicone
- Ideal in combination with our Magic-Clean cleaning putty



01

02

Cleaning putty red

Magic-Clean

- ▶ Item no. 2000-26
- ▶ Contents: 200 g
- ▶ Packing unit: 1

▶ **Technical specifications**

- Sharp cleaning putty
- Removes all stubborn deposits from paint and rims - such as rust bloom, brake dust, tar, tree resin, insects, burned-in metal dust and much more ...
- Supplied in a re-closable box

03

Cleaning putty blue

Magic Clean

- ▶ Item no. 2000-25
- ▶ Contents: 200 g
- ▶ Packing unit: 1

▶ **Product description**

- Effortlessly removes even the hardest dirt from painted surfaces
- Without aggressive solvents
- Removes industrial dust, surface rust, paint mist, dead insects, adhesive residue, tar and resin deposits



02

03



**ALL-STAR TRULY
REMOVES
ALL TYPES
OF DIRT!**

01

Power cleaner, exterior

All-Star

- ▶ Item no. 2000-312-5
- ▶ Contents: 5 litres
- ▶ Packing unit: 1

- ▶ Item no. 2000-312-30
- ▶ Contents: 30 litre
- ▶ Packing unit: 1

▶ **Product description**

- For universal use
- AOX-free
- Removes all types of stubborn road dirt
- Effortlessly removes oils, greases, nicotine and insects
- Gentle on paint, decorative trims and logos
- Specially made for high-pressure cleaners
- Can be used warm and cold

- **Mixing ratio:**

- High pressure cleaners: 1:1 to max. 1:6
- Low pressure / manual cleaning: 1:1 to max. 1:25

02

Interior/exterior power cleaner

All Star Protect

- ▶ Item no. 2000-318-5
- ▶ Contents: 5 litres
- ▶ Packing unit: 1

- ▶ Item no. 2000-318-30
- ▶ Contents: 30 litres
- ▶ Packing unit: 1

▶ **Product description**

- pH value 10
- Low colour and odour
- Aluminium-safe
(tested on the most common vehicles)
- AOX-free
- Free from solvents, silicates and phosphates

- **Mixing ratio:**

- High-pressure cleaners 1:5 to 1:20 (max. 50°C)
- Low pressure / manual cleaning 1:10 to max. 1:40



01



02

01
Power cleaner, inside/outside
Uni-Star

- ▶ Item no. 2000-02
- ▶ Contents: 5 litres
- ▶ Packing unit: 1

- ▶ Item no. 2000-02-30
- ▶ Contents: 30 litre
- ▶ Packing unit: 1

- ▶ **Product description**
- For universal use inside and outside
- AOX-free
- Removes all types of stubborn road dirt
- Effortlessly removes oils, greases, nicotine and insects
- Leaves behind no traces or matt surfaces
- Gentle on paint, decorative trims and logos

- Mixing ratio:
- High pressure cleaners: 1:1 to max. 1:10



02
Spout for 5 litre containers
▶ Item no. 2000-000-005

Spout for 30 litre containers
▶ Item no. 2000-000-030



03
Tarpaulin Cleaner
Cover-Star

- ▶ Item no. 2000-313-30
- ▶ Contents: 30 litre
- ▶ Packing unit: 1

- ▶ **Product description**
- Suitable for use with high-pressure cleaners
- Contains no halogenated hydrocarbons
- Free of adsorbent organic halogen compounds (AOX)
- Biodegradable



04
Rust film remover
Mega-Star

- ▶ Item no. 2000-10
- ▶ Contents: 5 litres
- ▶ Packing unit: 1

- ▶ **Product description**
- Cleaner for extreme inorganic dirt, e.g. concrete residue
- Effortlessly removes stubborn road dirt, brake dust, lime scale, hard deposits of oil, surface rust and rust bloom highly suitable for cleaning wheel rims
- AOX-free

- Mixing ratio: 1:10



01



03



04



01

Tar remover

Power Star Ultra

- ▶ Item no. 2000-04
- ▶ Contents: 5 litres
- ▶ Packing unit: 1

▶ Product description

- Loosens road tar
- Removes stickers on new cars
- Removes adhesive and sealing residue from all external plastic parts, paintwork and glass

03

Spout for 5 litre containers

- ▶ Item no. 2000-000-005

Spout for 30 litre containers

- ▶ Item no. 2000-000-030

02

Insect remover

Insect-Star Extreme

- ▶ Item no. 2000-322-5
- ▶ Contents: 5 litres
- ▶ Packing unit: 1

▶ Item no. 2000-322-30

- ▶ Contents: 30 litre
- ▶ Packing unit: 1

▶ Product description

- Special cleaner for the fast removal of dead insects
- Suitable for paintwork, glass, plastic and alkaline-resistant surfaces on all PCVs, HGVs, vans and trains
- Silicone-free



04

Active foam cleaner

Active Care

- ▶ Item no. 2000-401-30
- ▶ Contents: 30 litre
- ▶ Packing unit: 1

▶ Product description

- For soaking and cleaning heavy dirt and chemical pre-washes
- In car washes: Undiluted
- 1:1 using dosing pump (setting 8-20ml)

05

Drying accelerator

Speed-Dry

- ▶ Item no. 2000-404-30
- ▶ Contents: 30 litre
- ▶ Packing unit: 1

▶ Product description

- Supports the drying process by tearing open the water film
- Set car wash system to: neat
- 1:1 via the dosing pump (setting 8-20 ml)



01



03

02



04



06



01

Car Shampoo

Wash & Ready

- ▶ Item no. 2000-321-5
- ▶ Contents: 5 litres
- ▶ Packing unit: 1

- ▶ Item no. 2000-321-30
- ▶ Contents: 30 litre
- ▶ Packing unit: 1

- ▶ Product description
- Shampoo concentrate (can be diluted to 1:100)
- pH value 7.7
- Effortlessly removes grime and road dirt
- Leaves a shiny, streak-free surface



01

02

High gloss shampoo

Wash & Drive

- ▶ Item no. 2000-300-5
- ▶ Contents: 5 litres
- ▶ Packing unit: 1

- ▶ Item no. 2000-300-30
- ▶ Contents: 30 litre
- ▶ Packing unit: 1

- ▶ Product description
- Leaves a shiny and streak-free surface
- Silicone free
- AOX free
- Effortlessly removes road dirt and traffic deposits
- Cleans and polishes the paintwork in one application
- Can be diluted to: 15ml to 10 litres of warm water



02

03

Car-wash shampoo

Power Wash

- ▶ Item no. 2000-402-30
- ▶ Contents: 30 litre
- ▶ Packing unit: 1

- ▶ Product description
- Ideal for vehicle cleaning and providing good lubricity
- Set vehicle wash system to: neat
- 1:1 via the dosing pump (setting 8-15 ml)
- Machine cleaning: dilute up to 1:5,000 (depending on the level of soiling)
- Manual cleaning: dilute up to 1:50 (depending on the level of soiling).



03

01

Acid-free aluminium rim cleaner

Rimol Gold Protect

- ▶ Item no. 2897-328-30
- ▶ Contents: 30 litres
- ▶ Packing unit:

- ▶ Item no. 2897-328-500
- ▶ Contents: 500 ml
- ▶ Packing unit: 1

- ▶ Item no. 2897-328-5
- ▶ Contents: 5 litres
- ▶ Packing unit: 6

▶ **Product description**

- Acid-free
- Consists of 70% renewable raw materials, so environmentally friendly
- Contains no materials hazardous to health when evaporating off
- Gel-type viscosity
- Non-toxic
- Does not burn the skin
- Gentle cleaning



PROTECT THE GENTLE CHEMICAL!



01



02

Tyre installation paste

TAP

- ▶ Item no. 2894-455
- ▶ Contents: 5 kg
- ▶ Packing unit: 1

- ▶ Item no. 2894-457
- ▶ Contents: 5 kg
- ▶ Packing unit: 1

Black



White



▶ **Product description**

- Suitable for run-flat tyres
- Frost-proof
- Rapid drying, so that tyre cannot slip on rim
- Outstanding exhaust air behaviour
- High slip
- Biodegradable
- No risk of allergies for fitters



02



01 Special aluminium wheel rim cleaner
Rimol Profi

- ▶ Item no. 2897-321-5
- ▶ Contents: 5 litres
- ▶ Packing unit: 1

- ▶ Item no. 2897-321-30
- ▶ Contents: 30 litre
- ▶ Packing unit: 1

- ▶ Product description
- Acidic
 - Easily removes stubborn dirt (burnt in brake dust, rust film, abraded rubber, heavy oil incrustations, road dirt, etc.)



01

02 Aluminium Rim Cleaner
Rimol

- ▶ Item no. 2897-320-1
- ▶ Contents: 500 ml
- ▶ Packing unit: 6

- ▶ Product description
- Acidic
 - Easily removes stubborn dirt (burnt in brake dust, rust film, abraded rubber, heavy oil incrustations, road dirt, etc.)

03 Silicone-free tyre care product
New Wheel Plus

- ▶ Item no. 2897-339-400
- ▶ Contents: 400 ml
- ▶ Packing unit: 12

- ▶ Product description
- Waterproof
 - Quick drying
 - Silicone-free

04 Silicone-based care product
New Wheel Extreme

- ▶ Item no. 2897-338-400
- ▶ Contents: 400 ml
- ▶ Packing unit: 12

- ▶ Product description
- Waterproof
 - Quick drying
 - Containing silicone

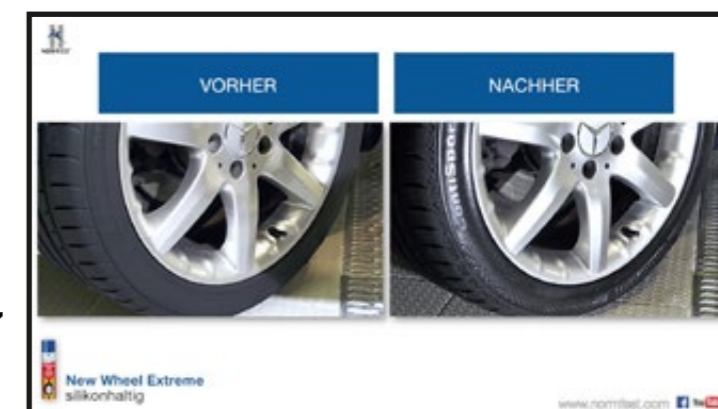

02



03



04



01
Engine compartment preservation
Motor-Fit

- ▶ Item no. 2000-307-1
- ▶ Contents: 1 litre
- ▶ Packing unit: 1

- ▶ Item no. 2000-307-5
- ▶ Contents: 5 litres
- ▶ Packing unit: 1

- ▶ Item no. 2000-307-30
- ▶ Contents: 30 litre
- ▶ Packing unit: 1

- ▶ **Product description**
- High shine
 - Water dispersing
 - Contains silicone
 - Contains no aromatic solvents
 - Protects electronic components



01

02
Care product for exterior plastic
Outplast

- ▶ Item no. 2000-319-500
- ▶ Contents: 500 ml
- ▶ Packing unit: 12

- ▶ **Product description**
- Provides long-lasting shine
 - Excellent surface protection against environmental damage
 - Silicone-free
 - Not suitable for interior plastic parts or painted plastics

03
Plastic dyer
Plast-PT

- ▶ Item no. 2897-041
- ▶ Contents: 75 ml
- ▶ Packing unit: 1

Black



- ▶ **Product description**
- Resistant to car washes, high pressure cleaners and solvents
 - For dyeing plastic
 - Incl. sponge



02



03



04

04
Rubber care
Outdoor

- ▶ Item no. 2000-306-1
- ▶ Contents: 1 litre
- ▶ Packing unit: 1

- ▶ Item no. 2000-306-5
- ▶ Contents: 5 litres
- ▶ Packing unit: 1

- ▶ **Product description**
- Provides a pleasant, matt and long-lasting shine
 - Has a high coverage rate and is quick drying
 - Does not leave sticky residue on the surface
 - Leaves no marks in adjacent surfaces (paintwork, hub caps)
 - Silicone-based

01

Intensive window cleaner

Topas

- ▶ Item no. 2897-310
- ▶ Contents: 400 ml
- ▶ Packing unit: 24

- ▶ Item no. 2000-03
- ▶ Contents: 5 litres
- ▶ Packing unit: 1

▶ **Product description**

- Silicone-free
- Also suitable for polycarbonate glass
- Safe for surfaces
- Foam formation only after the surface has been coated with the product

02

Universal foam cleaner

Multin

- ▶ Item no. 2897-342
- ▶ Contents: 600 ml
- ▶ Packing unit: 12

▶ **Product description**

- Active foam
- Cleans and degreases
- Powerful dissolving
- Leaves no residues
- Colour: White foam



03

Glass cleaner

Stries Protect

- ▶ Item no. 2897-340
- ▶ Contents: 500 ml
- ▶ Packing unit: 12

- ▶ Item no. 2897-340-5
- ▶ Contents: 5 litres
- ▶ Packing unit: 1

- ▶ Item no. 2897-340-30
- ▶ Contents: 30 litre
- ▶ Packing unit: 1

▶ **Product description**

- Removes dirt, marks, fingerprints, grease, nicotine, dead insects, etc.
- Free of silicone and ammonia
- Can be used on glass, polycarbonate glass



01



02



03



01
Rubber care pen
Rubber Fit

- ▶ Item no. 2897-335-75
- ▶ Contents: 75 ml
- ▶ Packing unit: 12

- ▶ Product description
- silicone-free
- splash- and saltwater resistant

Rubber Fit is a silicone-free care product for rubber components and seals in passenger cars. It contains natural waxes and beneficial additives, as well as being resistant to splash water, salt water, alkalis and acids.



01

02
Upholstery cleaner
Velvet

- ▶ Item no. 2897-307
- ▶ Contents: 400 ml
- ▶ Packing unit: 12

- ▶ Product description
- cleans and protects upholstery, carpets and roof lining
- removes greasy residue
- leaves a pleasant scent
- no vacuuming required



02

03
Leather care product
Ledanol

- ▶ Item no. 2000-310-1
- ▶ Contents: 1 litre
- ▶ Packing unit: 1

- ▶ Product description
- Cares for and protects leather
- Solvent-free
- Do not use on suede or similar surfaces



03

01

Intensive interior cleaner and care product

Interno Protect

- ▶ Item no. 2000-05
- ▶ Contents: 500 ml
- ▶ Packing unit: 12

- ▶ Item no. 2000-05-5
- ▶ Contents: 5 litres
- ▶ Packing unit: 1

▶ **Product description**

- Ready to use
- Free from acids and silicone
- Cares for hard and soft surfaces such as plastic, vinyl, chrome, sealing strips and door sill protectors, car leather, upholstery and carpets
- Not suitable for suede and Alcantara
- Leaves behind a matt finish on plastic surface and a pleasantly fresh fragrance
- Contains no hydrocarbon solvents

02

Cockpit spray, free of silicone and solvents

New Look Protect

- ▶ Item no. 2897-337-1

▶ **Technical specifications**

- Dust suppressing
- Antistatic
- Leaves a silky shine
- Leaves a neutral fragrance
- Cleaning and care for the dashboard, arm rests, mats, shelves, consoles

03

Interior Detailer

Crystal Ultra

- ▶ Item no. 2897-306
- ▶ Contents: 400 ml
- ▶ Packing unit: 6

▶ **Product description**

- Improved formula increases the cleaning and shine effect by up to 30%
- Application in cockpits, on door trims, foot mats and seats (except displays and tachometers)
- Loosens grease residue
- Leaves the vehicle looking and smelling new
- Acts anti-statically

04

Interior plastic care product

Indoor

- ▶ Item no. 2000-308-1
- ▶ Contents: 1 litre
- ▶ Packing unit: 1

▶ **Item no. 2000-308-5**

- ▶ Contents: 5 litres
- ▶ Packing unit: 1

▶ **Product description**

- Suitable for plastics and rubbers in the interior, cockpit, dashboards, door trims, storage trays, wooden covers and leather
- Care product containing silicone gives plastic a like-new appearance and leaves behind no residue
- Very easy to apply
- Free from volatile silicones
- Silk matt finish



01

02

03

04

01
Odour destroyer and air freshener
Aerofit Power

- ▶ Item no. 2000-309-400
- ▶ Contents: 400 ml
- ▶ Packing unit: 12

- ▶ **Product description**
- Immediately eliminates smells and freshens the interior
 - Long-lasting and economical
 - A high-pressure system with an extremely concentrated active ingredient
 - One squirt is sufficient for a large area
 - Raspberry fragrance



03
Manual sprayer flexible

- ▶ Item no. 2000-802-2

- ▶ **Product description**
- Suitable for overhead work
 - Leak-proof, with Viton seal
 - Steplessly adjustable nozzle – from fine spray to jet



01



02



02
Odour destructor
Aerofit Plus

- ▶ Item no. 2000-309-2
- ▶ Contents: 1 litre
- ▶ Packing unit: 1

- ▶ **Product description**
- Can be used on all fabric surfaces inside the vehicle as well in ventilation ducts without sensors
 - Effectively eliminates all unpleasant odours, e.g. nicotine
 - Solvent-free
 - Can be applied using a normal spray or pressure pump spray bottle
 - Also very easy to apply using a wet vacuum cleaner or nebuliser
 - Silicone-free



04
Odour eliminator and air freshener
Aerofit Fresh

- ▶ Item no. 2000-309-600
- ▶ Contents: 600 ml
- ▶ Packing unit: 12

- ▶ **Product description**
- Quick to work
 - Does not leave any marks
 - Biological fragrance
 - Removes bad smells
 - No heavy metals
 - Simple to use
 - A little goes a long way
 - Citrus fragrance



04

01

Air conditioning system cleaner

Viro One Shot Plus

- ▶ Item no. 2897-301
- ▶ Contents: 100 ml
- ▶ Packing unit: 10

▶ **Product description**

- For quick, easy and hygienic cleaning
- Eliminates dead microorganisms thoroughly
- Prevents allergic reactions
- Leaves a pleasant smell that lasts
- Contents are sufficient for one application
- Basis: alcohol

02

Air conditioning and ventilation system cleaner

Viro Air Fresh Plus

- ▶ Item no. 2897-302
- ▶ Contents: 300 ml
- ▶ Packing unit: 12

▶ **Product description**

- Spray enters the ventilation system directly via the capillary tube
- Long-lasting disinfection
- Leaves a pleasant citrus fragrance
- Contents sufficient for up to three applications
- Basis: alcohol

03

Air conditioning evaporator cleaner

Viro Vaporizer

- ▶ Item no. 2897-303
- ▶ Contents: 400 ml
- ▶ Packing unit: 12

▶ **Product description**

- Performs high-pressure flushing
- Effective in every corner of the evaporator
- Kills germs, bacteria and moulds
- Prevents the growth of microorganisms
- Ensures healthy and pleasant smelling air inside the vehicle
- Incl. 60 cm hose with rotor nozzle
- Sufficient product for one A/C system



01



02



03



01
UV leak search fluid
Tracer

- ▶ Item no. 5000-303
- ▶ Contents: 236 ml
- ▶ Packing unit: 1

▶ Product description

- This leakfinder additive does not contain solvents
- Ideal for use in combination with refrigerating oils (PAG, mineral oil, ester)
- Safe for all vehicle A/C systems and A/C service instruments
- Manufacturer approval
- Sufficient for approx. 25 PCV applications

02
UV leak-detector fluid for hybrid vehicles in combination with refrigerant R134a and 1234yf
UV hybrid

- ▶ Item no. 5000-304
- ▶ Contents: 240 ml
- ▶ Packing unit: 1

▶ Product description

- for use in combination with refrigerating oils (PAG, mineral oils, ester)
- Completely harmless for all hybrid-vehicles air conditioning systems and service equipment
- Suitable for both refrigerants (R134a & HFO1234yf)
- Does not attack O-rings or seals
- Non-conductive

03
UV-Additiv Tracer®
for R1234yf refrigerant

- ▶ Item no. 5000-305
- ▶ Contents: 237 ml
- ▶ Packing unit: 6

▶ Product description

- This leakfinder additive does not contain any solvents
- For use in combination with refrigerating oils (PAG, mineral oil, ester)
- Safe for all vehicle A/C systems and A/C service instruments
- Manufacturer's approval
- For approx. 25 car applications

04
Oil-Fluid
Fluorescent leakfinder fluid for engines and gearboxes

- ▶ Item no. 5000-205-1
- ▶ Contents: 25 ml
- ▶ Packing unit: 1

▶ Product description

- Sufficient for one vehicle/one application



04

05
Water-Fluid
Fluorescent leakfinder fluid for cooling systems

- ▶ Item no. 5000-206-1
- ▶ Contents: 25 ml
- ▶ Packing unit: 1

▶ Product description

- Sufficient for one vehicle/one application



05



01



02



03

NEU

06
PAG 46 Oil
AC compressor oil for R134a refrigerant - Low viscosity

- ▶ Item no. 5000-220
- ▶ Contents: 250 ml
- ▶ Packing unit: 1

▶ Technical specifications

- The product is not suitable for refrigerant R1234yf,



06

07
PAG 100 Oil
AC compressor oil for R134a refrigerant - Low viscosity

- ▶ Item no. 5000-221
- ▶ Contents: 250 ml
- ▶ Packing unit: 1

▶ Technical specifications

- The product is not suitable for refrigerant R1234yf,



07

01 Climate-control compressor oil

PAG46 OIL 1234yf / for coolant 1234yf

- ▶ Item no. 5000-218
- ▶ Contents: 250 ml
- ▶ Packing unit: 12

▶ **Product description**

- A multigrade compressor oil for all cars, trucks, buses and agricultural equipment filled with 1234yf coolant
- For hybrid vehicles filled with 1234yf coolant
- Perfectly lubricates and cools climate-control compressors
- Guarantees thermal stability in compressors

02 Multigrade compressor oil
Multi POE Oil Premium

- ▶ Item no. 5000-219
- ▶ Contents: 1 litre
- ▶ Packing unit: 1

▶ **Product description**

- A multi-range compressor oil for A/C systems using 1234yf or R134a as refrigerant
- Can also be used on A/C systems in hybrid vehicles filled with 1234yf or R134a
- To reduce wear, lubricate and cool A/C compressors in the refrigerant range
- Compatible with all known mineral, ester and PAG oils

03 Sealing compound for A/C systems
Quick-Seal Cold

Quick-Seal Cold

- ▶ Item no. 5000-230
- ▶ Contents: 40 ml
- ▶ Packing unit: 1

▶ **Product description**

- Used to seal micro-leaks in shaft seals, hoses and O-rings in car climate-control systems
- Contents sufficient for one use
- The product contains 44 grams of R134A coolant
- CAUTION! Quick-Seal-Cold must not be used in hermetically-sealed systems!
- IMPORTANT! Use only possible with the adapter, available separately. (art. no. 5000-230-1)



06 Adapter set for refrigerant R1234yf

- ▶ Item no. 5000-229-1

▶ **Product description**

- A differentiation is made between the following adapters:

- Honeywell 1/2"-16 ACME LH
- DuPont W 21.8 x 1/14"LH

- The DuPont adapter can also be used for our cylinders.

04 Refrigerant R134A

- ▶ Item no. 5000-225-9

▶ **Product description**

- 12.7 kg reusable bottle

05 Refrigerant R1234yf

- ▶ Item no. 5000-229

▶ **Product description**

- 5.0 kg Reusable bottle



01



02



03



04



05



06

01

Multipurpose primer

1K-Multi-Connector

- ▶ Item no. 2893-900
- ▶ Contents: 400 ml
- ▶ Packing unit: 12

Light grey



- ▶ Item no. 2893-900-20
- ▶ Contents: 400 ml
- ▶ Packing unit: 12

Dark grey



▶ **Product description**

- Recoatable without sanding
- With fan spray head
- Substrates: Galvanised sheet steel and aluminium, plastic, wood, etc.
- Particularly suitable for protecting the edges of filled areas
- Ideal for all difficult substrates, also suitable for plastic and wood

02

Base primer

Baso Plus

- ▶ Item no. 2893-889
- ▶ Contents: 400 ml
- ▶ Packing unit: 24

Light grey



▶ **Product description**

- High filling properties
- Improved coverage due to increased number of pigments
- Temperature resistant up to 100°C
- Overpaintable with nitro, acrylic and water-based paints
- Fan spray head enables vertical and horizontal application



03

Thick film filler

One-component multi filler

- ▶ Item no. 2893-902
- ▶ Contents: 400 ml
- ▶ Packing unit: 10

▶ **Product description**

- High filling volume
- Easy to sand
- Quick drying
- With cone spray head

04

Primer filler

2-component epoxy primer filler

- ▶ Item no. 2800-760
- ▶ Contents: 400 ml
- ▶ Packing unit: 6

Beige



▶ **Product description**

- Gloss level: matt
- Colour: beige
- Long-lasting corrosion protection on all surfaces, e.g. zinc, aluminium, steel, etc.
- Proportion of solid particles: 50-53% by weight on diluted paint (without propellant gas)



01



02



03



04

01

Spray paint

Corona

- ▶ Item no. 2893-886
- ▶ Contents: 400 ml
- ▶ Packing unit: 6

Black



- ▶ Item no. 2893-887
- ▶ Contents: 400 ml
- ▶ Packing unit: 1

Silver



▶ **Product description**

- Heat resistant up to 650°C
- Weatherproof
- Resistant to wear and abrasion
- Free of heavy metals

02

Wheel rim silver

Silver Star

- ▶ Item no. 2893-883
- ▶ Contents: 400 ml
- ▶ Packing unit: 24

Silver



▶ **Product description**

- Good coverage
- Abrasion resistant
- Car-wash resistant
- Resistant to de-icing salt, stone impacts, etc.
- Free from heavy metals: No lead, cadmium or chromium

03

Black matt RAL 9005

Kroma

- ▶ Item no. 2893-884
- ▶ Contents: 400 ml
- ▶ Packing unit: 24

Black



▶ **Product description**

- Very good coverage
- Light resistant
- High proportion of solid matter
- Scratch resistant

04

glossy black

Spray paint

- ▶ Item no. 2893-885
- ▶ Contents: 400 ml
- ▶ Packing unit: 24

Black



▶ **Product description**

- this RAL spray paint is characterised by its fine flowing texture and good, colour-true coverage



01



02



03



04



01
2K-Clear varnish

- ▶ Item no. 2800-770
- ▶ Contents: 400 ml
- ▶ Packing unit: 6

- ▶ Product description
- Weatherproof
- Resistant to chemicals
- Resistant to petroleum
- Excellent filling properties

02
Spot blender paint

- ▶ Item no. 2800-780
- ▶ Contents: 400 ml
- ▶ Packing unit: 6

- ▶ Product description
- corrects paint transitions when filling paint

03
Silicone remover

- ▶ Item no. 2800-720
- ▶ Contents: 400 ml
- ▶ Packing unit: 6

- ▶ Product description
- Suitable for all cleaning tasks prior to and after painting, e.g. tar spatter, diesel exhaust particles, etc.

04
High-gloss clear varnish

- ▶ Item no. 2893-803
- ▶ Contents: 400 ml
- ▶ Packing unit: 6

- ▶ Technical specifications
- Protects new sheet metal against rusting
- Weldable
- Abrasion resistant after drying
- High corrosion protection
- High percentage of activesubstances



01



02



03



04

Aerosol can & accessories

- ▶ Item no. 2893-
- ▶ Aerosol can



- ▶ Item no. 2893-900-1
- ▶ Spray head (cone)

- ▶ Item no. 2893-900-3
- ▶ Fan nozzle



- ▶ Item no. 2893-900-2
- ▶ Pistol grip



TIP

RAL PAINT SPRAYS ARE RAPID-DRYING NITRO-COMBINATION PAINTS. THEY HAVE OUTSTANDING ADHESION PROPERTIES ON METAL AND VARIOUS PLASTICS*. * WITH CONNECTION TO 1K MULTI CONNECTOR ART. NO.: 2893-900

Paint spray

► Product description

- Extremely weather-resistant
- Quick-drying
- Excellent coverage
- High solid body content
- Resistant to scratches
- Free from heavy metals: no lead, cadmium or chromium

RAL 9010

Pure white

- Item no. 2893-810-006
- Contents: 400 ml
- Packing unit: 6

► Suitable for:

Mercedes Benz / Iveco / Scania
Tractors / Agricultural machinery
MB box body
MAN driver's cab
RAL 9010 = Iveco IC-082

RAL 9005

Night black

- Item no. 2893-810-008
- Contents: 400 ml
- Packing unit: 6

► Suitable for:

Mercedes Benz / Iveco
MAN chassis / German army
RAL 9005 = Iveco IC-248 / MB 9040

RAL 3000

Fire red, silk

- Item no. 2893-810-001
- Contents: 400 ml
- Packing unit: 6

► Suitable for:

Agricultural machinery / DAF
RAL 3000 = IC-096 / MB3524

RAL 5010

Gentian blue

- Item no. 2893-810-009
- Contents: 400 ml
- Packing unit: 6

► Suitable for:

Mercedes Benz / Unimog
THW vehicles / containers
MAN driver's cab
German Railways / diggers
RAL 5010 = Iveco IC-071 / MB 5361

RAL 3002

Carmine red

- Item no. 2893-810-007
- Contents: 400 ml
- Packing unit: 6

► Suitable for:

MAN driver's cab /
Iveco / DAF
RAL 3002 = Iveco IC 186 / MB 3535



RAL 9006
White aluminium

- ▶ Item no. 2893-820-005
- ▶ Contents: 400 ml
- ▶ Packing unit: 6

▶ Suitable for:
Aluminium superstructures
Aluminium rims
German Railways
Agricultural machinery / chassis



MB 7354
Argentite grey

- ▶ Item no. 2893-830-003
- ▶ Contents: 400 ml
- ▶ Packing unit: 6

▶ Suitable for:
Mercedes Benz



RAL 9007
Grey aluminium

- ▶ Item no. 2893-870-001
- ▶ Contents: 400 ml
- ▶ Packing unit: 6

▶ Suitable for:
Construction machinery



RAL 7012
Basalt grey

- ▶ Item no. 2893-870-002
- ▶ Contents: 400 ml
- ▶ Packing unit: 6

▶ Suitable for:
Liebherr cranes
Construction machinery

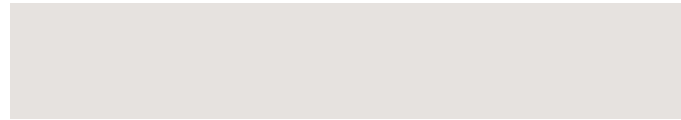

MB 9147
Arctic white

- ▶ Item no. 2893-830-008
- ▶ Contents: 400 ml
- ▶ Packing unit: 6

▶ Suitable for:
Mercedes Benz



DB 7350
Nova grey

- ▶ Item no. 2893-830-009
- ▶ Contents: 400 ml
- ▶ Packing unit: 6

▶ Suitable for:
Mercedes Benz
DB 7350 = MB 7350



RAL 7021
Black-grey

- ▶ Item no. 2893-870-003
- ▶ Contents: 400 ml
- ▶ Packing unit: 6

▶ Suitable for:
German army construction machinery



RAL 5002
Ultramarine

- ▶ Item no. 2893-870-004
- ▶ Contents: 400 ml
- ▶ Packing unit: 6

▶ Suitable for:
THW (Technisches Hilfswerk, Federal Agency for
Technical Relief)
MAN chassis
DAF



RAL 2011
Deep orange

- ▶ Item no. 2893-850-006
- ▶ Contents: 400 ml
- ▶ Packing unit: 6

▶ Suitable for:
Mercedes Benz
Municipal vehicles
Construction machinery
RAL 2011 = MB2603



RAL 9011
Graphite black

- ▶ Item no. 2893-860-002
- ▶ Contents: 400 ml
- ▶ Packing unit: 6

▶ Suitable for:
MAN standard chassis colour
Tractors / agricultural machinery



Komatsu yellow
Special colour

- ▶ Item no. 2893-870-005
- ▶ Contents: 400 ml
- ▶ Packing unit: 6

▶ Suitable for:
Fork-lift truck



RAL 7024
Graphite grey

- ▶ Item no. 2893-870-006
- ▶ Contents: 400 ml
- ▶ Packing unit: 6

▶ Suitable for:
Mercedes Benz

01
Fibreglass putty incl. hardener (2893-139)
 Compound

- ▶ Item no. 2893-109-9
- ▶ Contents: 1.8 kg
- ▶ Packing unit: 4

- ▶ Product description
- Outstanding direct adhesion on metal substrates
- Ideal for filling small surfaces, unevenness and grooves



01

04
Fine filler with curing agent (2893-139)
 Finish

- ▶ Item no. 2893-112-9
- ▶ Contents: 2 kg
- ▶ Packing unit: 4

- ▶ Product description
- for filling small areas, ridges and grooves
- adheres to aluminium, plastics, steel and galvanised steel



04

02
Multisoft filler with curing agent (2893-139)
 Multi

- ▶ Item no. 2893-101-9
- ▶ Contents: 2 kg
- ▶ Packing unit: 4

- ▶ Product description
- For filling large cavities
- Adheres to aluminium, plastics, steel and galvanised steel



02

05
Aluminium filler with curing agent (2893-139)
 Aluminium

- ▶ Item no. 2893-103-9
- ▶ Contents: 1.8 kg
- ▶ Packing unit: 4

- ▶ Product description
- For filling large cavities as well as parts exposed to vibrations and oscillations
- Adheres to aluminium, plastics and galvanised steel



05

03
Universal filler with curing agent (2893-139)
 Uni

- ▶ Item no. 2893-106-9
- ▶ Contents: 2 kg
- ▶ Packing unit: 4

- ▶ Product description
- For filling small surfaces, unevenness and grooves
- Adheres to aluminium, plastics and steel (but not to galvanised steel)



03



06

07

06
Body filler application set

- ▶ Item no. 8715-65-00

- ▶ Product description
- 4 blades
- Acid-proof plastic grips

07
Plastic smoothing spatula

- ▶ Item no. 2893-164
- ▶ PU: 10



01 Exhaust repair paste
Asbestos-free

- ▶ Item no. 2893-148
- ▶ Contents: 150 g
- ▶ Packing unit: 12

- ▶ Product description
- Quick drying
 - Highly viscous
 - Asbestos-free



01

02 Exhaust repair paste
Asbestos-free

- ▶ Item no. 2893-149-1
- ▶ Contents: 150 g
- ▶ Packing unit: 12

- ▶ Product description
- Quick drying
 - Highly viscous
 - Asbestos-free
 - For sealing junctions



02

03 Drive shaft joint grease
Greasor

- ▶ Item no. 5884-950
- ▶ Contents: 90 ml
- ▶ Packing unit: 1

- ▶ Product description
- High quality lithium soap grease with MoS2 as solid lubricant
 - Specially designed for highly loaded constant velocity joints and is ideal for greasing and lubricating slip and fixed joints as well as ball bearings.



03

04 Matting paste
Scraper

- ▶ Item no. 2000-314-1
- ▶ Contents: 1 litre
- ▶ Packing unit: 1

- ▶ Product description
- Conditions surfaces for areas to be painted in
 - designed specifically for use with non-woven web
 - increases grinding



04

01

Hand protection

Aquano Protect

- ▶ Item no. 2897-500-225
- ▶ Contents: 250 ml
- ▶ Packing unit: 1

- ▶ Item no. 2897-500-2
- ▶ Contents: 2 litres
- ▶ Packing unit: 1

▶ **Product description**

- Protects the skin when dealing with aqueous and non-aqueous materials such as cooling lubricants, dilute acids, alkalis, oils, grease, tar, paints, adhesives, etc.
- Quickly absorbed
- Non-greasy
- pH neutral
- Silicone-free
- Dermatologically tested
- Hypoallergenic

02

Aquano Protect Plus

Excellent skin protection

- ▶ Item no. 2897-500-825
- ▶ Contents: 250 ml
- ▶ Packing unit: 1

- ▶ Item no. 2897-500-8
- ▶ Contents: 2 litres
- ▶ Packing unit: 1

▶ **Product description**

- Dirt-repelling skin protection that can be washed off
- for strongly adhesive, non-aqueous materials, such as oils, paints, bitumen, adhesives, resins, PU foams, etc.
- Made from raw materials with a natural basis
- Free from mineral oils, silicone oils and their derivatives, as well as preservatives

Skin Protection Plan Item no. 2897-500-7

1 HAUTSCHUTZ → vor der Arbeit
Aquano Protect
 Der langanhaltende Hautschutz für alle Anwendungsbereiche.
 - schützt die Haut vor wässrigen und nicht wässrigen Arbeitsstoffen
 - dermatologisch getestet

2 HAUTREINIGUNG → für die Verschmutzung
Aquano Clean
 Die milde und neutrale Reinigungslotion für starke Verschmutzungen.
 - reinigt potentiell
 - ist hautfreundlich mit Rückfettung

Aquano Spezial
 Die Reinigungslotion mit Doppelwirkung für extreme Verschmutzungen.
 - sehr gute Hautverträglichkeit
 - dermatologisch getestet

3 HAUTPFLEGE → nach der Arbeit
Aquano Lotion
 Die wirkstofffreie Hautpflege mit natürlichen Vitaminen.
 - revitalisiert die Haut
 - wirkt gegen trockene, rissige und leicht entzündliche Haut

03

Skin Care

Aquano Lotion

- ▶ Item no. 2897-500-325
- ▶ Contents: 250 ml
- ▶ Packing unit: 1

- ▶ Item no. 2897-500-3
- ▶ Contents: 2 litres
- ▶ Packing unit: 1

▶ **Product description**

- Promotes the regeneration of affected areas of skin
- Suitable for the entire body
- With natural oils and vitamin E
- Non-replenishing
- pH neutral
- Slightly perfumed
- Silicone-free
- Dermatologically tested



01

Hand Cleaner

Aquano Clean

- ▶ Item no. 2897-500-125
- ▶ Contents: 250 ml
- ▶ Packing unit: 1

- ▶ Item no. 2897-500-1
- ▶ Contents: 2 litres
- ▶ Packing unit: 1

▶ **Product description**

- Deep cleansing and long-lasting skin protection
- Hand cleaner easily removes tar, oil, dirt, bitumen and much more
- Aquano is sufficiently replenishing
- Does not block drains
- Silicone-free and dermatologically tested
- Hypoallergenic

02

Special hand cleaner

Aquano Spezial

- ▶ Item no. 2897-500-4
- ▶ Contents: 250 ml
- ▶ Packing unit: 1

- ▶ Item no. 2897-500-42
- ▶ Contents: 2 litres
- ▶ Packing unit: 1

▶ **Product description**

- Intensive, skin-friendly special hand cleaner for very heavy soiling, e.g. paint, acrylic paint, varnish, etc.
- Deep-down cleansing
- Slightly moisturising
- Does not block drains
- Free from preservatives and fragrances
- Silicone free
- Dermatologically tested
-
- Aquano Spezial must not come into contact with plastic surfaces as these may be damaged.

03

Dispenser

Intended for use with 2 litre system bottles

- ▶ Item no. 2897-500-6

▶ **Product description**

- Comes with a pre-installed pump for dispensing hand protection products
- Made from plastic

- Scope of delivery:
 - 1 x system dispenser
 - 4 x 6 mm dowel, stainless-steel screws and washers
 - 1 x key
 - 1 x rotating head
 - 1 x dosing piece
 - 1 x set of installation and operating instructions



03



01



02

04

Hand cleaning Paste

Removes dirt, such as oil, grease, etc.

- ▶ Item no. 2897-240-8
- ▶ Contents: 10 kg jumbo pail
- ▶ Packing unit: 1

▶ **Product description**

- Dermatologically tested
- Silicone free
- Alkali free
- Wood flour based



04

01
Care Protect
The invisible glove

- ▶ Item no. 2897-240-1
- ▶ Contents: 1 litre of lotion
- ▶ Packing unit: 1

- ▶ **Product description**
- Lies on the skin like an invisible protective glove
- Protects the skin when dealing with various materials such as cooling lubricants, dilute acids, alkalis, oils, grease, tar, bitumen and much more
- Silicone-free
- pH skin neutral
- Dermatologically tested
- Non-greasy

02
Care Soft
Hand-Cleaning Lotion

- ▶ Item no. 2897-240-3
- ▶ Contents: 1 litre
- ▶ Packing unit: 1

- ▶ **Product description**
- Particularly skin-friendly cleansing that seriously replenishes the skin thanks to high-quality ingredients
- Particularly suitable for sensitive skin and frequent washing
- pH skin neutral
- Dermatologically tested

03
Care Lotion
Skin Care

- ▶ Item no. 2897-240-2
- ▶ Contents: 1 litre
- ▶ Packing unit: 1

- ▶ **Product description**
- Slightly moisturising skin care lotion, easy to apply and absorbed quickly
- Promotes the regeneration of stressed and dry skin
- Silicone free
- pH neutral
- Dermatologically tested

04
Care Clean
Hand cleaner

- ▶ Item no. 2897-240
- ▶ Contents: 3 litre bucket
- ▶ Packing unit: 1

- ▶ **Item no. 2897-240-010**
- ▶ Contents: 1 litre
- ▶ Packing unit: 10
- ▶ **Product description**
- Removes oil, grease, tar, printing ink, bitumen, etc.
- Deep-down cleansing
- Long-lasting protective effect
- Moisturising
- pH neutral
- Dermatologically tested



05
Nail brush
Bristle type: hard

- ▶ Item no. 2897-500-9

- ▶ **Product description**
- Bristle length: 17 mm
- Colour: black
- Dimensions (H x L x W): 38 mm x 48 mm x 118 mm
- Max. cleaning temperature: +121° C
- Product meets EU Regulation no. 10/2011 regarding food contact: YES



**IT'S ALMOST UNBELIEVABLE
WHAT THIS PRODUCT CAN DO!**

**01
Organic binding agent for oil and chemicals
Suitable for indoor and outdoor use**

Oil-Catcher Premium

- ▶ Item no. 7874-150-1
- ▶ Contents: 1 litre
- ▶ Packing unit: 1

- ▶ Item no. 7874-150
- ▶ Contents: 50 litres
- ▶ Packing unit: 1

- ▶ **Technical specifications**
- Fast absorption of oils, chemicals, fuels, paints, and much more.
- Basis: Natural fibre
- pH value: 3.8
- Universally applicable
- For indoor and outdoor use
- Can be used in all conditions
- Reusable until complete saturation
- Non-toxic to humans, animals and the environment
- Can be used on any surface
- Economical and easy to use
- Easy to dispose of
- No long-term contamination of soils, water or aquifers
- No long-term physical or visual effect on the environment



**02
Oil binder
Oil-Catcher Outdoor**

- ▶ Item no. 7874-40
- ▶ Contents: 40 litre
- ▶ Packing unit: 1

- ▶ **Product description**
- An oil binder specially developed for outside use
- Has such a high weight of its own that there is no more drifting
- Grain: 0.125 - 4.0 mm



02

01

Workshop cleaner

Bio-Star

- ▶ Item no. 2897-250-5
- ▶ Contents: 5 litres
- ▶ Packing unit: 1

- ▶ Item no. 2897-250-30
- ▶ Contents: 30 litre
- ▶ Packing unit: 1

▶ **Product description**

- Highly active concentrate for cold and high-pressure cleaning
- Suitable for cleaning heavily soiled factory floors, walls and floor tiles
- Removes lubricating oil, grease, soot, pigments, resin and tar
- High-pressure cleaner mixing ratio: 1:3 to 1:5
- Mixing ratio for manual use: 1:1 to 1:5
- pH value: 11.2 (alkaline)
- AOX-free

Spout for 5 litre containers

- ▶ Item no. 2000-000-005

Spout for 30 litre containers

- ▶ Item no. 2000-000-030



01



02

Oil-stain remover

Oel-Ex

- ▶ Item no. 2897-341
- ▶ Contents: 400 ml
- ▶ Packing unit: 12

▶ **Product description**

- Effective aid against oil stains and old oil stains
- Removes oil stains from all absorbent and non-absorbent substrates, such as stone, natural stone and concrete blocks, clay and pumice, screed, clinker and ceramic
- Can also be used on carpets and textile flooring
- Colour: White
- Important: Do not use on bitumen, asphalt or slate!



02

EFFECTIVE HELPER AGAINST OIL AND WASTE-OIL STAINS!!!

 GERMANY

Normfest GmbH
Siemensstr. 23
D-42551 Velbert
Tel: +49 2051 275 0
Fax: +49 2051 275 - 141
E-mail: info@normfest.de
www.normfest.com



 OUR BUSINESS UNITS

Normfest GmbH
dress & safe
Im Lipperfeld 9
46047 Oberhausen
Germany
Tel.: +49 208 60 70 100
Fax: +49 208 60 70 - 190
E-mail: info@dress-safe.de
www.dress-safe.de

dress&safe

Normfest GmbH
CODESI
Siemensstr. 23
D-42551 Velbert
Tel: +49 2051 275 200
Fax: +49 2051
275 27 - 200
E-mail: info@codesi.de
www.codesi.de



 POLAND

Normfest Polska Sp. z o.o.
ul. Wichrowa 4 /10
PL-60-449 Poznań
Tel.: +48 61 8 439 140
Fax: +48 61 8 439 142
E-mail: info@normfest.pl



Czech Republic
Normfest s.r.o.
Pekarská 12
CZ-155 00 Praha 5
Tel.: +420 257 013 280
Fax: +420 257 013 281
E-mail: info@normfest.cz

© Normfest GmbH 2016

Subject to errors, misprints and technical changes.
Reprinting, duplication or reproduction, in whole or in part, is only permitted following prior approval by the publisher.

WE ARE REPRESENTED IN THE FOLLOWING COUNTRIES

BY OUR SPECIALIST RETAIL PARTNERS:

 GREAT BRITAIN

Euro Car Parts Limited
Fulton Road / Wembley
Industrial Estate
UK-Wembley, Middlesex, HA9 0TF
Tel.: +44 20 89 56 50 23
Fax: +44 20 89 00 02 48
www.eurocarparts.com

 Netherlands

 Macedonia

 Azerbaijan

 Georgia

 France

 Sri Lanka

 Russia

 Vietnam

 Israel

 Finland

 Serbia

 Malta

 Greece

 Estonia

 Latvia

 Lithuania

 AUSTRIA



Kellner & Kunz AG
Boschstr. 37
A-4601 Wels
Tel.: +43 7242 4840
Fax: +43 7242 48429
E-mail: info@reca.co.at
www.reca.co.at

 SPAIN



RECA HISPANIA S.A.U.
AVDA. OVIDI MONTLLOR NO.7
ES-46960 ALDAYA-VALENCIA
TEL.: +34 96 15194 - 60
FAX: +34 96 15191 - 05
E-MAIL: INFO@RECA-
HISPANIA.COM
WWW.RECAHISPANIA.COM

 ITALY



SCAR Srl
via Caduti sul Lavoro, 25
I-37012 | Bussolengo (VR)
Tel.: +39 045 676 8311
Fax: +39 045 676 - 8400

 SLOVAKIA



RECA Slovensko s.r.o.
Vajnorska 134 / B
SK-831 04 Bratislava
Tel.: +421 2 444 55 916 - 8
Fax: +421 2 444 55 900
E-mail: reca@reca.sk

 CROATIA



RECA d.o.o.
Kucanska BB
HR-42000 Varazdin
Tel.: +385 42 350 - 813
Fax: +385 42 350 - 818

 BOSNIA-HERZEGOVINA



RECA d.o.o.
Hifzi Bjelaca 11A
BIH-71210 Ilidža - Sarajevo
Tel.: +387 33777 720
Fax: +387 33789 520
reca@reca.ba
www.reca.ba